



Developing a Mixture Design Specification for Flexible Base Construction

Technical Report 0-6621-1

Cooperative Research Program

TEXAS TRANSPORTATION INSTITUTE
THE TEXAS A&M UNIVERSITY SYSTEM
COLLEGE STATION, TEXAS

TEXAS DEPARTMENT OF TRANSPORTATION

in cooperation with the
Federal Highway Administration and the
Texas Department of Transportation
<http://tti.tamu.edu/documents/0-6621-1.pdf>

1. Report No. FHWA/TX-12/0-6621-1	2. Government Accession No.	3. Recipient's Catalog No.	
4. Title and Subtitle DEVELOPING A MIXTURE DESIGN SPECIFICATION FOR FLEXIBLE BASE CONSTRUCTION		5. Report Date October 2011 Published: June 2012	
7. Author(s) Jon Epps, Stephen Sebesta, Hakan Sahin, Joe Button, Rong Luo, and Robert Lytton		6. Performing Organization Code	
9. Performing Organization Name and Address Texas Transportation Institute The Texas A&M University System College Station, Texas 77843-3135		8. Performing Organization Report No. Report 0-6621-1	
12. Sponsoring Agency Name and Address Texas Department of Transportation Research and Technology Implementation Office P. O. Box 5080 Austin, Texas 78763-5080		10. Work Unit No. (TRAIS)	
15. Supplementary Notes Project performed in cooperation with the Texas Department of Transportation and the Federal Highway Administration. Project Title: Developing a Mixture Based Specification for Flexible Base URL: http://tti.tamu.edu/documents/0-6621-1.pdf		11. Contract or Grant No. Project 0-6621	
16. Abstract In the Texas Department of Transportation (TxDOT), flexible base producers typically generate large stockpiles of material exclusively for TxDOT projects. This large "state-only" inventory often maintained by producers, along with time requirements for testing and reduced manpower within TxDOT offices, resulted in this project's investigation into a mixture-design specification for flexible base. The goals of this project are to develop a flexible base specification that reduces TxDOT's burden for sampling and testing, reduces time and space burdens on producers for maintaining TxDOT-only stockpiles, and maintains or improves the quality of the base. To facilitate accomplishing these goals, this project developed a draft quality control/quality assurance (QC/QA) specification for flexible base. Based on a thorough review of background information, sampling and testing placeholders for placement and production aggregate and mixture tests were selected and incorporated into a classical QC/QA format draft specification. While the current draft specification largely uses existing TxDOT test procedures, improvements may be realized by considering the Grace methylene blue method and the use of index tests as surrogates for modulus and permanent deformation properties. The methylene blue method may be able to better control the quantity and amount of fines, while linking index tests to mechanistic properties could enable acceptance testing better linked to design assumptions. The second year of this project will sample and test flexible base quarries around the state to determine material variability that is attainable in the real world without compromising the design strength.		13. Type of Report and Period Covered Technical Report: September 2010–August 2011	
17. Key Words Flexible Base, Quality Control, Quality Assurance, QC/QA, Specification, Mix Design, JMF		14. Sponsoring Agency Code	
19. Security Classif. (of this report) Unclassified		18. Distribution Statement No restrictions. This document is available to the public through NTIS: National Technical Information Service Alexandria, Virginia 22312 http://www.ntis.gov	
20. Security Classif.(of this page) Unclassified		21. No. of Pages 174	22. Price

DEVELOPING A MIXTURE DESIGN SPECIFICATION FOR FLEXIBLE BASE CONSTRUCTION

by

Jon Epps
Executive Associate Director
Texas Transportation Institute

Stephen Sebesta
Associate Research Scientist
Texas Transportation Institute

Hakan Sahin
Graduate Assistant Researcher
Texas Transportation Institute

Joe Button
Senior Research Fellow
Texas Transportation Institute

Rong Luo
Associate Research Engineer
Texas Transportation Institute

and

Robert Lytton
Research Engineer
Texas Transportation Institute

Report 0-6621-1
Project 0-6621

Project Title: Developing a Mixture Based Specification for Flexible Base

Performed in cooperation with the
Texas Department of Transportation
and the
Federal Highway Administration

October 2011
Published: June 2012

TEXAS TRANSPORTATION INSTITUTE
The Texas A&M University System
College Station, Texas 77843-3135

DISCLAIMER

The contents of this report reflect the views of the authors, who are responsible for the facts and the accuracy of the data presented herein. The contents do not necessarily reflect the official views or policies of the Texas Department of Transportation (TxDOT) or the Federal Highway Administration (FHWA). This report does not constitute a standard, specification, or regulation. The engineer in charge was Jon Epps, P.E. (Texas, #31291).

The United States Government and the State of Texas do not endorse products or manufacturers. Trade or manufacturers' names appear here solely because they are considered essential to the object of this report.

ACKNOWLEDGMENTS

This project was made possible by the Texas Department of Transportation and the Federal Highway Administration. Special thanks must be extended to Caroline Herrera, P.E., for serving as the project director.

TABLE OF CONTENTS

	Page
List of Figures	x
List of Tables	xi
Chapter 1. General Literature Review	1
Overview	1
Laboratory and Field Tests for Flexible Base.....	1
Promising New Tests for Potential Use in Specification.....	18
Conclusions.....	25
Chapter 2. Summary of Relevant prior TxDOT Research Projects	27
Overview	27
Project 0-4182: Full-Depth Recycling: Field Performance and Design Guidelines.....	28
Project 0-5223: The Effects of Pulverization on Design Procedures	28
Project 0-5797: Design, Constructability Review, and Performance of Dual Base Stabilizer Applications	30
Project 0-5562: Guidelines for Using Local Materials for Roadway Base and Subbase	30
Project 0-4358: Materials, Specifications, and Construction Techniques for High Performance Flexible Bases	31
Project 0-5268: Role of Coarse Aggregate Point and Mass Strength on Resistance to Load in HMA	34
Project 0-4774: New Technologies for Measuring Pavement Quality	35
Current TxDOT Projects.....	35
Chapter 3. Synopsis of Relevant Non-TxDOT Flexible Base Specifications	37
Overview.....	37
Discussion of Other Agency Specifications	42

Chapter 4. Historical Findings of Recycled Materials Use in Flexible Base	45
Overview.....	45
Reclaimed Asphalt Pavement	45
Reclaimed Concrete Aggregate	55
Laboratory Tests on Base Materials Containing Recycled Pavement Materials.....	58
Building Derived Aggregate	62
Potential Findings from Ongoing Road Tests.....	62
Conclusions.....	63
Chapter 5. Smoothness Acceptance Criteria for Flexible Base	65
Overview.....	65
Issues that Affect Base Smoothness	67
Measures to Enhance Base Ride Quality	69
Recommendations.....	71
Chapter 6. Potential Approaches for Establishing Performance-Based Pay Factors	73
Overview.....	73
Laboratory Test Plan.....	73
Repeated Load Triaxial Test.....	75
Conclusions.....	77
Chapter 7. Development of Draft Mixture-Based Specification for Flexible Base	79
Overview.....	79
Selection of Tests for Inclusion in Specification.....	79
General Considerations for Drafting Specification.....	81
Continued Development of Specification.....	83
Chapter 8. Conclusions and Recommendations.....	85
Overview.....	85
Recommendation for Sampling and Testing.....	85
Recommendation for Specification Revision	87
References.....	89
Appendix A. Tests for Developing Performance-Based Pay Factors.....	93

Appendix B. Technical Approach for Pay Factor Determination: Predicting Moduli of Anisotropic Unbound Aggregate Base 99
Appendix C. Draft Mixture-Based Specification for Flexible Base 121

LIST OF FIGURES

	Page
Figure 1.1. Humboldt GeoGauge (Model H-4140) (http://www.humboldtmfg.com).....	18
Figure 1.2. Methylene Blue Values with Bentonite and Kaolinite.....	22
Figure 1.3. Development of Colorimetric Methylene Blue Test for Inclusion in Flexible Base Mixture Design Specification.	22
Figure 1.4. Development of Index Tests for Verification of Resilient Modulus.....	24
Figure 2.1. Field FWD Modulus of Bases Constructed under Project 7-3931 (7).	32
Figure 4.1. Modified Proctor Compaction Curves for Pit Run Blends (20).	49
Figure 4.2. Resilient Modulus of Compacted RAP-Blended Specimens (24).....	50
Figure 4.3. Relationship between Shear Strength and RAP Content (after Mokwa and Peebles, 2005).	51
Figure 4.4. Average R-Value as a Function of RAP Content (after Mokwa and Peebles, 2005).	51
Figure 4.5. Permanent Deformation of Compacted RAP-Blended Specimens (after Bennert et al. 2000).....	53
Figure 4.6. Resilient Moduli of Compacted Specimens with RCA (24).	56
Figure 4.7. Permanent Deformation of Compacted Specimens with RCA (24).....	57
Figure 4.8. Compaction Method Comparison Using Field Blend (approximately 75% DGABC + 25% RAP) (28).	60
Figure 5.1. Distributions of Average IRIs on Flexible Base and First Course Surface Treatment on FM 2401 Project in the Odessa District (30).....	67
Figure 5.2. Cumulative Distributions of Average Flexible Base IRIs – Atlanta and Odessa Projects (30).....	68
Figure 6.1. Potential Test Plan to Link Lab Tests to Performance for Flexible Base.	74
Figure 6.2. Repeated Load-Permanent Deformation Test (after Hoyt et al. 1987).	76
Figure A.1. Sieves and Sieve Shaker for Tex-110-E.	93
Figure A.2. AIMS Apparatus Shown (Left) and Texture, Angularity, and Form of an Aggregate Illustrated (Right).	94
Figure A.3. Hand-Operated Liquid Limit Device.....	95
Figure A.4. W. R. Grace Methylene Blue Test (W. R. Grace and Co.).....	95
Figure A.5. Soil Samples and Filter Papers for Matrix and Total Suction (Lytton et al. 2004).	96
Figure A.6. Mid Plane Suction Probe and the Porous Tip Schematic.	97
Figure A.7. The Repeated Load Triaxial Test Apparatus (Gidel et al. 2001).....	98
Figure B.1. Configuration of Rapid Triaxial Test.....	104
Figure B.2. Hardening Component of Vertical Modulus (Ashtiani et al. 2010).	108
Figure B.3. Effect of Pore Water Pressure in Aggregate Base.	109
Figure B.4. Vertical Modulus of Texas Limestone Base under Different Tire Pressure.....	109
Figure B.5. Climatic Zones in Texas (Gharaibeh et al. 2010).	113
Figure B.6. Predicted Rutting Life in Climatic Zone I.	114
Figure B.7. Predicted Rutting Life in Climatic Zone II.	114
Figure B.8. Predicted Rutting Life in Climatic Zone III.....	115
Figure B.9. Predicted Rutting Life in Climatic Zone IV.	115

LIST OF TABLES

	Page
Table 1.1. Laboratory Aggregate Tests.....	2
Table 1.3. Field Tests for Flexible Base.	6
Table 1.4. Preliminary Test Properties for Inclusion in Flexible Base QC/QA Specification.	20
Table 2.1. Revised FDR Guidelines (1).....	28
Table 2.2. Base Materials Used on FM 1810 in Project 7-3931 (5).	32
Table 2.3. Heavy-Duty Base Material Proposed in Project 0-4358 (10).	34
Table 3.1. Types of Tests and Specifications for Granular Base Materials Used by Selected Highway Specifying Agencies.	38
Table 4.1. Recycled Aggregate Particle Properties that Influence Pavement Performance (17).....	46
Table 4.2. Relevance of Recycled Material Properties for Various Applications (17).	47
Table 4.3. Selected Materials or Blends with Expected Performance Potential (17).	55
Table 4.4. Rating of Potential Test Methods for Evaluating Recycled Aggregates (17).....	61
Table 6.1. A List of Base Course Properties Obtained by the Laboratory Tests.	75
Table 7.1. Tests for Aggregate Properties.	79
Table 7.2. Tests for Mixture Properties.	80
Table 7.3. Tests for Production Testing.....	80
Table 7.4. Tests for Placement Testing.....	81
Table 7.5. Major Sections of Specification.....	81
Table 8.1. Sampling Plan for Establishing Variability.	86
Table 8.2. Testing Planned for Development of Acceptable Tolerances.	87
Table B.1. Weibull Distribution Parameters of Aggregate Geometric Characteristics (after Ashtiani 2009).....	100
Table B.2. Weibull Distribution Parameters of Aggregate Matrix Gradation.....	101
Table B.3. Properties of Aggregate Matrixes (after Ashtiani 2009).....	102
Table B.4. Example Test Results of Rapid Triaxial Test.	104
Table B.5. Predicted Matrix Suction and R-Squared Value of Mechanistic Models.	107
Table B.6. Predicted k Values of Aggregate Matrixes.	110
Table B.7. Correlation between Aggregate Properties and k Values.	111
Table B.8. Deep Rutting Prediction Model Coefficients for Pavement Family A with Preventive Maintenance under Low Traffic.	113
Table C.1. Material Requirements.	150
Table C.2. Requirements for Recycled Portland Cement Concrete (RPCC).....	151
Table C.3. Requirements for Reclaimed Asphalt Pavement.....	151
Table C.4. Test Methods, Test Responsibility, and Minimum Certification Levels.	152
Table C.5. Reporting Schedule.	155
Table C.6. Minimum Sampling and Testing Requirements.	156
Table C.7. Allowable Material Property (Production) Differences and Specification Limits.	157
Table C.8. Production Testing Frequency.	158
Table C.9. Placement Testing Frequency, Allowable Differences, and Specification Limits.	159

Table C.10. Pay Adjustment Factor for Thickness..... 159

CHAPTER 1.

GENERAL LITERATURE REVIEW

OVERVIEW

The research team conducted a comprehensive general literature review using search tools available at Texas A&M University and Texas Transportation Institute (TTI) libraries.

Specific databases queried include:

- Transportation Research Information Services (TRIS).
- National Technical Information Service (NTIS).
- Federal Highway Administration (FHWA).
- National Cooperative Highway Research Program (NCHRP).
- U.S. Army Corps of Engineers.
- Transportation Research Board (TRB).
- National Stone Association (NSA).

Over 400 references were located and their abstracts reviewed. The most applicable references provided information on individual aggregate properties as well as mixture properties used in flexible base specifications and performance evaluations. The research team specifically sought any references that addressed how these aggregate and mixture properties influence pavement performance. The remainder of this chapter presents laboratory and field tests that may be candidates for use in a flexible base specification. Next, a brief synopsis of the tests is presented. Finally, a summary of the most promising tests currently not used in TxDOT is presented. These promising tests that may be candidates for inclusion in a QC/QA specification for flexible base include the:

- Methylene blue value using the Grace (colorimetric) method.
- Determination of performance parameters (modulus and permanent deformation) through index tests.

LABORATORY AND FIELD TESTS FOR FLEXIBLE BASE

Based on the general literature review, Tables 1.1–1.2 summarize the laboratory tests identified for aggregates and mixtures, respectively. Table 1.3 presents field tests identified in the literature.

Table 1.1. Laboratory Aggregate Tests.

Property	Test Name	Performance Predictability	Materials and Testing	Test Turnaround Time	Precision	Spec Type	Equipment Cost	Status	Reference
Particle Size Analysis	Gradation Dry/Wet Sieve Analysis	Fair	Standard ASTM test	1 day	Unknown	QC, QA	\$1,000	ASTM C 136-06 (Dry), ASTM C 117 - 04 (Wet), TEX-110-E	In many agency standard specifications
Shape/Surface Texture	Particle Index Test	Fair	Standard ASTM test	Unknown	Fair	QC, QA	Unknown	ASTM D3398-00	Saeed, A., et al. (2001).
	Particle Shape and Surface Texture Index	Fair	Standard ASTM test	Unknown	Fair	QC, QA	Unknown	ASTM D 4791, BS 812-75	Saeed, A., et al. (2001).
Shape, Dry Strength	Flat and Elongated Particles	Poor	Most states measure the ratio of the minimum dimension to the maximum dimension of aggregate particle, 1:3, to 1:5.	1 day	Fair	QC, QA	\$200	CRD-C 119-53, CRD-C 120-55, and ASTM D 4791	Lang, A., et al. (2007) and Saeed, A., et al. (2001).
	Percentage of Fractured Particles	Good	Not available	1 day	Fair	QC, QA	\$1,000	CRD-C 171-95 and ASTM D 5821	Lang, A., et al. (2007) and Saeed, A., et al. (2001)
Amount/Activity of Fines	Atterberg Limits	Fair	Standard AASHTO test	1 day	Fair	QC, QA	\$500	AASHTO T 89, and T 90, TEX-104-E 105-E, 106-E	Saeed, A., et al. (2001).
	Sand Equivalent Test	Fair	Passing the No. 4 sieve is place in a cylinder which filled with calcium chloride. After agitation 20 min. of settling and a height for clay plus sand is obtained visually.	1 day	Fair	QC, QA	\$700	ASTM D 2419	Saeed, A., et al. (2001).
	Methylene Blue Test	Good	An MB solution which consists of 1 g of MB and 1000 ml of distilled water is titrated in 0.5 ml a liquates. Each addition of MB solution and 1 min. of stirring a small drop placed on filter paper. This process is repeated until a light blue "halo" forms around the drop.	At least 30 min.	Unknown	QC, QA	\$350	ASTM D2330, AASHTO TP 57	Saeed, A., et al. (2001).
	Grace Methylene Blue Test (colorimetry)	In development	1-Mix 20 g of sand with 0.5% w/v methylene blue solution. 2-Take aliquot of methylene blue solution after mixing. 3-Dilute aliquot of methylene blue solution. 4-Measure quantity of methylene blue remaining by colorimetry.	In less than 10 min.	Unknown	QC, QA	\$1,500	Not adopted	W. R. Grace Co.

Table 1.1. Laboratory Aggregate Tests (continued).

Property	Test Name	Performance Predictability	Materials and Testing	Test Turnaround Time	Precision	Spec Type	Equipment Cost	Status	Reference
Degradation	LA Abrasion	Fair	Standard ASTM and AASHT1.510 test	1 day	Fair	QC, QA	\$6,000	ASTM C 131 and AASHTO T 96	In many agency standard specifications
	Aggregate Impact Value (AIV)	Fair	A standard sample gradation with size from ½ to ¾ in is subject to impact loading in the form of 15 blows from a 100-mm diameter, 130 lb drop hammer falling 15 in.	1 day	Good	QC, QA	Unknown	British Reference Test Method, BS 812 Part 3	Saeed, A., et al. (2001)
	Aggregate Crushing Value (ACV)	Good	A sample approximately 2 kg (4.4 lb.) of aggregate size ½ to ¾ in.	1 day	Fair	QC, QA	Unknown	British Reference Test Method, BS 812 Part 3	Lang, A., et al. (2007) and Saeed, A., et al. (2001)
	Durability Mill	Fair	20 kg sample of aggregate is split into 4 subsamples. Sample 1 – test for gradation and Atterberg limit; Sample 2 – placed in the durability mill in soaked condition and tested 10 min.; Sample 3- placed in durability mill in dry state and test 10 min.	1 day	Fair	QC, QA	\$4,000	TEX-116-R	Saeed, A., et al. (2001)
	Sulfate Soundness	Poor	Sample is immersed in a solution of sodium or magnesium sulfate of specific strength for a period of 16 to 18 hours at a temperature of 70 F. The sample is drained for 15 min. and oven-dried to a constant weight	2 days	Poor	QC, QA	Unknown	AASHTO T 104	Lang, A., et al. (2007) and Saeed, A., et al. (2001)
	Freezing and Thawing	Good	Option A – Immerse in water for 24 hr. prior to initiation of freeze-thaw cycles. Option B – Saturate sample using a vacuum of not over 25.4 mm. of mercury; use a 0.5% ethyl alcohol-water for immerse. Option C – Same as Option B except water is used instead of alcohol-water solution	2 days	Fair	QC, QA	Unknown	AASHTO T 103	Lang, A., et al. (2007) and Saeed, A., et al. (2001)
	Aggregate Abrasion Value (AAV)	Fair	Standard AASHTO test	Unknown	Fair	QC, QA	Unknown	AASHTO T 85	Saeed, A., et al. (2001)
	Canadian Freeze-Thaw	Good	19 mm to 13.2 mm; 13.2 mm to 9.5 mm; 9.5 mm to 4.75 mm samples are soaked for 14 hr. in 3% NaCl solution, drained, sealed and cycled 5 times, frozen for 16 hr. at 18°C, thawed at room temperature for 8 hr.	7 days	Fair	QC, QA	\$2,500	Not available	Saeed, A., et al. (2001)
	Aggregate Durability Index	Fair	A washed and dried sample of coarse aggregate is agitated for 10 min. The resulting wash water and minus No. 200 are collected and mixed in a cylinder. After 20 min. sedimentation time the level of the sedimentation is read.	1 day	Fair	QC, QA	\$1,000	AASHTO T 210 (Coarse Aggregate) AASHTO T 176 (Fine Aggregate)	Saeed, A., et al. (2001)

Table 1.1. Laboratory Aggregate Tests (continued).

Property	Test Name	Performance Predictability	Materials and Testing	Test Turnaround Time	Precision	Spec Type	Equipment Cost	Status	Reference
Degradation (continued)	Micro-Deval	Good	Performed on an aggregate sample consisting of 750 grams of ¾ to ½ in. (19–13 mm) material and 750 grams of ½ to ¼ in. (13 to 9.5 mm) material	Soaked in water for 24 hrs and revolve 2 hrs.	Fair: Variation 3.2%	QC, QA	\$5,000	AASHTO TP 58-99	Lang, A., et al. (2007) and Saeed, A., et al. (2001)
Mineralogy	Petrographic Examination	PN > 200 poor performance; PN < 200 good performance	Standard ASTM test	Unknown	Fair	QC, QA	\$50,000	ASTM C 295	Lang, A., et al. (2007) and Saeed, A., et al. (2001)
Deleterious Material	Decantation	Unknown	Standard ASTM and AASHTO test	Unknown	Unknown	QC, QA	Unknown	ASTM C 142 – 97, AASHTO T 112	ASTM C 142 – 97, AASHTO T 112

Table 1.2. Laboratory Mixture Tests.

Property	Test Name	Performance Predictability	Materials and Testing	Test Turnaround Time	Precision	Spec Type	Equipment Cost	Status	Reference
Amount/Activity of Fines, Wet Strength	Tube Suction Test	Fair	Cylindrical specimens undergo a capillary soak while the surface dielectric constant of the specimen is monitored	7 days	Fair	QC, QA	\$8,000	Draft TxDOT procedure; never Adopted	Saeed, A., et al. (2001)
Dry and Wet Strength	Static Triaxial Shear Test	Fair	The test is conducted on specimens compacted to 95 % of the maximum dry density at the OMC as determined	To keep the testing time reasonable, 1,000 cycles at each load level are applied at a rate of 60 cycles per minute, thus requiring approximately 17 min. to complete each load level.	Good	QC, QA	\$15,000	AASHTO T 296	Saeed, A., et al. (2001)
	Direct Shear Test	Fair	Standard ASTM test	Sample test range 0-15 psi	Fair	QC, QA	\$8,000	ASTM D 3080 and AASHTO T 236	Saeed, A., et al. (2001)
Dry and Wet Strength, Load Distribution	Texas; Triaxial Test	Fair	Specimen is 6 in. diameter by 8 1/2 in. high mold. Specimen is left in water overnight	Applying an axial load at a rate of .15 in./min. Several samples are tested from 0-20 psi.	Fair	QC, QA	\$15,000	AASHTO T 212	Saeed, A., et al. (2001)
	Rapid Triaxial Test (RaTT)	Good	Cylindrical specimens are tested for vertical and horizontal modulus in a rapid-setup triaxial cell	3 to 5 days	Unknown	QC, QA	\$120,000	Research use	TTI (internal)
Wet Strength, Load Distribution	California Bearing Ratio (CBR)	Fair	6 in. specimen compacted according to AASHTO T 180, submerged in water for 4 days.	Penetrating the sample using a 3 sq. in. piston at a rate of 0.05 in./min.	Fair	QC, QA	\$6,000	AASHTO T 193	Saeed, A., et al. (2001)
Dry and Wet Strength, Anisotropy, Stress Dependency, Moisture Sensitivity	Repeated Load Triaxial Test	Good	Cylindrical specimens with heights approximately twice their diameter. For the dry test, samples were allowed to consolidate overnight in the triaxial cell under a confining pressure.	The time of testing depended on the number of load levels, the selected number of load cycles per load level, and the loading frequency but no more than 5 hrs.	Good	QC, QA	\$15,000	AASHTO T 180 and AASHTO T 294-94	Saeed, A., et al. (2001)
Load Distribution, Stress Dependency	Resilient Modulus	Fair	6 in. diameter specimen with a maximum aggregate size of 1/2 in.	Load pulse duration of approximately 25 to 150 msec. is used, and the load pulse repeated 15 to 60 times per minute	Fair	QC, QA	\$3,000	AASHTO T 294-94, ASTM D 7369-09 and SHRP Protocol P 46	Saeed, A., et al. (2001)
	Variable Confining Pressure Modulus	Fair	Unknown	Unknown	Fair	QC, QA	Unknown	Unknown	Saeed, A., et al. (2001)
Volume Change	California Swell Test	Unknown	Unknown	Unknown	Unknown	QC, QA	\$1,000	Unknown	Unknown
	Texas Swell Potential	Unknown	Unknown	Unknown	Unknown	QC, QA	Unknown	Unknown	Unknown
Volume Change, Moisture Sensitivity	Frost Susceptibility Test	Fair	Standard ASTM test	Unknown	Poor - Fair	QC, QA	Unknown	ASTM 5918-06	Saeed, A., et al. (2001)
Permeability	Constant (Static) Head Permeameter	Fair	Standard AASHTO test	30 minutes	Fair	AT	Unknown	AASHTO T 215	Saeed, A., et al. (2001)
	Falling Head Permeameter	Fair	A 6 in.-diameter sample is exposed to a falling head of water	20 min. to several hours or days depending on material permeability	Fair	AT	\$1,000	FM 5-513	Saeed, A., et al. (2001)

Table 1.3. Field Tests for Flexible Base.

Property	Test Name	Measurement from Test	Test Turnaround Time	Precision	Spec Type	Equipment Cost	Status	Reference
Water Content	Speedy (Calcium Carbide)	Measures the moisture content of materials passing the No. 4 sieve.	10 minutes	Unknown	QC, QA	\$2,000	ASTM D 4944, AASHTO T-27, Tex-425-A	Sebesta, S., et al. (2006)
	Adek Down Hole Dielectric Probe	The down hole dielectric probe measure dielectric constant of the soil.	10 minutes	Unknown	QC, QA	\$10,000	No spec	Sebesta, S., et al. (2006)
	AquaPro Moisture Probe	Measures the moisture content of subgrade and base materials.	10 minutes	± 2%	QC, QA	\$1,000	No spec	Sebesta, S., et al. (2006)
	Vertek SMR Probe	Measures the moisture content of subgrade and base materials.	10 minutes	Unknown	QC, QA	\$7,500	No spec	Sebesta, S., et al. (2006)
Density, Water Content	Density Tube Sampler	Measures the in-place density of subgrade materials.	1 day	Unknown	QC, QA	\$300	ASTM D 2937, AASHTO T-20	Sebesta, S., et al. (2006)
	Nuclear Field Testing Device	Measures the wet and dry density and water content of the soil/base material by means of a radioactive source.	5 minutes	Unknown	QC, QA	\$15,000	ASTM D 6938	Standard test method
	Sand Cone Test	Test measures subgrade or base density	20 minutes	Unknown	QC, QA	\$100	ASTM D 1556, AASHTO T 181, T 191	Sebesta, S., et al. (2006)
	Balloon Density Test	Test measures density of subgrade and base materials	20 minutes	Unknown	QC, QA	\$500	ASTM D 2167, AASHTO T 205	Sebesta, S., et al. (2006)
Thickness, Water Content, Smoothness	Ground Penetrating Radar (GPR)	A system traditionally used for measuring layer thicknesses, GPR shows promise for evaluating the uniformity of a project and can potentially measure moisture content of soils and bases.	30 minutes for field surveys; 1 to 3 days if calibration to lab water content is performed	Unknown	AT, PF	\$30,000 – \$50,000	No spec	Sebesta, S., et al. (2006), Scullion, T., et al. (2003), Chen D. et al. (2008)
Strength	Plate Load Test (PLT)	Estimates bearing capacity by field loading.	15 minutes	Unknown	QC, QA	Unknown	ASTM D 1194 (withdrawn)	Seyman, E. (2003)

Table 1.3 Field Tests for Flexible Base. (continued)

Property	Test Name	Measurement from Test	Test Turnaround Time	Precision	Spec Type	Equipment Cost	Status	Reference
Load Distribution	Portable Falling Weight Deflectometer	This unity measures vertical displacement of the surface at 3 points spaced 30 cm. (11.81 in.) apart in response to a vertical impact load.	5 minutes	Unknown	AT, PF	\$15,000	ASTM E 2583	Rich, D., J. (2010)
	Dynamic Cone Penetrometer (DCP)	A device with a conical tip that is driven into the soil and traditionally used to measure bearing capacity, but has been related to modules and Texas Triaxial Classification	5 minutes	Unknown	AT, QC, QA	\$2,500	ASTM D 6951	Kessler (2005); Sebesta, S. et al. (2006), Chen, D. et al. (2008), Seyman, E. (2003)
	Instrumented Vibratory Roller	A system utilizing an accelerometer on the arm of a vibrating smooth drum roller to measure displacement of the roller drum. Such a system potentially can measure the uniformity and stiffness properties on a project.	Varies with quantity of area surveyed; typically 10 to 30 minutes	± 1%	AT, PF	About \$30,000 added to the roller cost	Pilot projects conducted in several states.	Rich, D., J. (2010); Sebesta, S., et al. (2006)
	Falling Weight Deflectometer (FWD)	TxDOT's standard field tool for structural evaluation of pavements, this device potentially could be used as a final quality assurance check on a completed pavement structure. Additionally, the level of coverage with this device could provide enough information to evaluate uniformity of the project.	5 minutes or less per test location.	Unknown	AT, PF	Unknown	ASTM D 4695	Lytton (1989); Scullion et. al., (1989); Chen, D. et al (2008)
	Portable Seismic Property Analyzer (PSPA)	The average modulus of the exposed surface layers can be estimated within a few seconds in the field.	3 minutes	Unknown	QC, QA	Unknown	Unknown	Celaya, M., et al. (2009)
	Geogauge	Resilient Modulus	5 minutes	Unknown	QC, QA	\$6,500	ASTM D 6758	Sebesta, S., et. al. (2006)

Synopsis of Laboratory and Field Tests

Standard Triaxial Test

The Triaxial test assesses materials to determine shear strength under controlled drainage conditions. A test specimen has a cylindrical shape, is prepared at the target moisture content and density, and then is encased in a rubber membrane. The specimen is placed in a compression chamber to load until axial failure. The Triaxial test provides data to determine stress-strain curves and a Mohr diagram as well as an aggregate characteristic from the internal friction angle, ϕ and cohesion, c . The Triaxial test is a standard test method of AASHTO T 296 for cohesive soils.

Texas Triaxial Test

The Texas Triaxial test was developed by the Texas Department of Transportation (TxDOT) and is a version of the standard triaxial test. A cylindrical sample is compacted in four layers. The sample is prepared and encased in a rubber membrane, then immersed in water overnight to increase the degree of saturation. The next day, the specimen is placed in the Texas Triaxial test device and an axial load is applied. This is repeated with multiple samples for testing at different confining pressures. Based on test results, Mohr circles are drawn, and the Mohr failure envelope is estimated.

Direct Shear Test

The direct shear test is a standard test method of AASHTO T 296 (ASTM D 3080) and has been used to test fine-grained soils and granular materials. The sample is placed into the shear box, and a normal vertical force applied to the specimen, A horizontal shear force is applied to the box to determine the magnitude of the shear force.

California Bearing Ratio (CBR)

The California Highway Department developed the CBR testing apparatus. In order to run the test, a 6-in. compacted sample is submerged in water several days. Specimens are prepared based on the AASHTO T 180. The test consists of penetrating the sample and recording the

corresponding penetration into the specimen as the penetration force. CBR values can range from low values for soft to higher values for quality crushed materials. In addition, CBR values also may relate to shear strength in fine-grained soils and to stiffness in high-strength granular materials.

Constant Head

The simplest of all methods for determining the coefficient of permeability is the constant head type test. This test is performed by measuring the quantity of water flowing through the specimen, the head of water, and elapsed time. Laboratory evaluation of the permeability of unbound granular aggregate may be determined by the constant head method AASHTO T 215 T.

Falling Head Test

The Falling Head test is conducted in the same manner as the Constant Head test. However, in the Falling Head test, the head of water is not maintained at a constant level, but is permitted to fall within the upper part of the specimen container or in a standpipe directly connected to the specimen.

Permeability Test Using Pressure Chamber

Permeability can be determined using a triaxial test setup as in ASTM Test Method D 5084 where a cylindrical specimen is confined in a rubber membrane and subject to a confining pressure during the permeability test.

Frost Susceptibility

The U.S. Army Corps of Engineers frost design soil classification system is based on particle size and the Unified Soil Classification method. The U.S. Army Corps of Engineers Arctic Construction and Frost Effect Laboratory in the laboratory and in the field led to the development of the Frost Susceptibility classification system. Soil type, the amount finer than 0.02 mm, and the plasticity index are used in the classification system. The Frost Susceptibility rating is the result of hundreds of laboratory frost-heave tests in which severe moisture and freezing conditions were imposed and field observations were made of frost heave and bearing capacity after thaw.

Tube Suction Test

This test consists of monitoring the capillary rise of moisture within a 12-inch cylinder of compacted aggregate. A dielectric probe measures the “free” or unbound water within the aggregate sample. The unbound water, rather than just the simple moisture content, is thought to be related to the strength of the material and to its ability to withstand repeated freeze-thaw cycling.

Gradation

Sieve analyses for coarse and fine aggregates are performed in accordance with AASHTO T 27-93. Fines or “dust,” which are those particles passing the No. 200 sieve, should be determined by washing in accordance with AASHTO T 11-91. The shape of particle size distribution curves can provide an indication of aggregate properties. Aggregate descriptions that reflect this shape include uniformly graded, gap graded, and dense graded.

Index of Aggregate Particle Shape and Surface Texture

In 1967, Huang developed a procedure for evaluation of the particle shape and surface texture of coarse aggregates. The test method is based on the concept that the volume of voids between packed, uniform-size coarse aggregate particles indicates the combined effect of shape, angularity, and surface texture of the aggregate. To perform the test, the aggregates are separated into individual-size fractions, washed, and oven dried. Each aggregate size fraction is compacted into its appropriate mold twice using different levels of compactive effort.

Flat and Elongated Particles

ASTM D 479 determines the percentage of flat and elongated particles in coarse aggregates, which are defined as those particles of aggregate having a ratio of width to thickness or length to width greater than a specified value.

Percentage of Fractured Particles

ASTM D 5821, a test to determine the percentage of fractured particles in the gravel size fractions, is performed on material retained on the No. 4 sieve. A fractured face is defined as a

face that exposes the interior of a gravel particle. Fractured particles contained in the sample are weighed after separation and the percentage by weight is determined.

Loose Versus Compacted Unit Weights and Voids

Standard methods for determining the unit weight of aggregates can be used to characterize the shape, angularity, and surface texture of particles. The void content of an aggregate blend can be determined after it has been subjected to several different types of compaction. The standard methods for determining unit weight are presented in ASTM C 29-91.

Digital Image Analysis

Digital image analysis provides the capability for rapid measurement of particle geometric characteristics using computer-based methods for gathering information. First a two-dimensional image of an aggregate particle is digitized into picture elements. The computer uses the pixels that make up the aggregate particle to calculate many characteristics. The Aggregate Imaging Systems uses this method on collections of aggregate particles and generates cumulative distributions of indexes of particle shape, angularity, and texture of each entire collection. For example, by scaling the picture, the computer can calculate maximum particle dimension, minimum particle dimension, area, and perimeter length.

Los Angeles Abrasion

The Los Angeles City Engineer developed the Los Angeles (LA) Abrasion test in 1916, which was later adopted as AASHTO Method T 96 (ASTM C 131). This test uses a large, hollow steel cylinder, which is rotated 500 revolutions at about 30 rpm. A shelf within the drum lifts and drops the aggregate sample and steel balls about 685 mm (26.97 inches) during each revolution. After completion of the 500 revolutions, the sample is removed and sieved dry over a No. 12 sieve. The percent passing this sieve is termed the LA Abrasion value.

Aggregate Crushing Value

Found in the British Standard BS 812, Part 3, this test calls for a sample of approximately 2 kg (4.4 lb) of aggregate size $\frac{1}{2}$ to $\frac{3}{8}$ inch to be placed in a rigid cylindrical mold and subjected to a static compressive load transmitted through a piston. A total load of 90,000 lb on a 150-mm

diameter piston is applied for 10 minutes. The resulting fines, passing the BS 2.40-mm sieve, are measured, and the percentage of the initial sample weight is termed the Aggregate Crushing Value.

Micro-Deval Abrasion Test

Originally developed in France, this test is performed on an aggregate sample consisting of 250 grams of 3/4- to 1/2-inch material and 250 grams of 1/2- to 3/8-inch material. The sample is soaked in water for 24 hours and placed in a jar mill with 2.5 liters of water and an abrasive charge consisting of 11 lb of 3/8-inch diameter steel balls. The jar, aggregate, water, and abrasive charge revolve at 100 rpm for two hours. The sample is then washed and dried. The amount of material passing the No. 16 sieve is determined, and the loss, expressed as a percentage by weight of the original sample, is calculated.

Durability Mill

This device, developed in South Africa, is similar to the Texas Ball Mill and consists of the testing of four subsamples of 3.5 kg each obtained from splitting of a 20 kg sample of aggregate materials. A Durability Mill Index (DMI) is then computed from the highest Plasticity Index (PI) and the highest amount of material passing the No. 200 sieve.

Sulfate Soundness Test

The AASHTO T 104 sulfate soundness test provides an estimate of the resistance of aggregate to weathering action. An aggregate sample is washed, dried, and separated into the prescribed fractions. The sample is immersed in a solution of sodium or magnesium sulfate of specified strength for a period of 16 to 18 hours at a temperature of 70°F. The sample is then removed, drained for 15 minutes, and oven-dried to a constant weight. Upon completion of the final cycle, the sample is sieved over various sieves and the maximum weighted average loss is reported as the sulfate soundness loss.

Freezing and Thawing Test

The AASHTO T 103 freeze-thaw test is intended to evaluate aggregates under simulated freeze-thaw weathering. The test requires an aggregate sample to be washed and dried to

constant weight and separated into separate fractions. After completion of the final cycle, samples are dried to constant weight and sieved. The resulting weighted average loss for each size fraction is used as the indication of soundness of the aggregate.

Canadian Freeze-Thaw Test

The test is conducted by placing three fractions of aggregate into separate 1-liter jars. The three fractions are 19 mm to 13.2 mm, 13.2 mm to 9.5 mm, and 9.5 mm to 4.75 mm. Samples are soaked for 24 hours in a 3 percent sodium chloride solution, drained, sealed and cycled five times, frozen for 16 hours at -18°C , and thawed at room temperature for eight hours. The material is then drained, dried, and re-sieved using the original sieve sizes. The weighted average loss for the sample is determined from the original grading and the percent loss from all three fractions.

Aggregate Durability Index

The durability index, as determined by AASHTO T 210, is a value indicating relative resistance of an aggregate to produce detrimental clay-like fines when subjected to mechanical agitation in the presence of water. A washed and dried sample of coarse aggregate is agitated in water with a mechanical washing vessel for a period of 10 minutes. The durability index has been used in limited geographical areas of the United States., primarily the western states, and the results have been correlated with aggregate performance with use of granular base materials.

Atterberg Limits

The Atterberg limits that are used most frequently in reference to base course aggregate fines are liquid limit (LL), plastic limit (PL), and plasticity index (PI). LL and PL are determined in accordance with AASHTO T 89 and T 90, respectively. Percent moisture is the unit for both LL and PL. PI is calculated as the difference in moisture content between LL and PL

Sand Equivalent Test

The purpose of this test is to provide an indication of the relative proportions of clay-like or plastic fines and dust in granular soils. This test has been standardized as ASTM D 2419-91. The test is designed to provide rapid results in the field, so it is simple to perform. The material

tested passes the 4.75-mm (No. 4) sieve. The sand equivalent is the ratio of the height of the sand to the height of clay plus sand times 100. A higher sand equivalent value indicates cleaner fine aggregate (lower clay particles).

Methylene Blue Test

The International Slurry Seal Association (ISSA) recommends this French test method to quantify the amount of harmful components in fine aggregate, including clays of the smectite group, organic matter, and iron hydroxides. A representative sample of fine aggregate is screened through the No. 200 sieve and a portion of the sample passing the sieve is used for the methylene blue (MB) test. One gram of the sample of fines is dispersed in 30 ml of distilled water and is mixed continuously. An MB solution, which consists of one gm of MB and 1000 ml of distilled water, is then titrated into the beaker step wise in 0.5-ml aliquotes. After each addition of MB solution and one minute of stirring, a small drop of aggregate suspension is removed from the beaker and is placed on filter paper. This process is repeated until a light blue “halo” forms around the droplet.

Petrographic Examination

A petrographic number (PN), developed in Canada, has been recommended for predicting performance of granular base materials. Aggregates that yield poor performance in granular base courses generally have a PN value greater than 200, whereas satisfactorily performing aggregates have much lower PN values.

Portable Falling Weight Deflectometer

A hand-operated portable falling weight deflectometer measures a deflections bowl and provides data that can be used to back-calculate the modulus of individual pavement layers.

Dynamic Cone Penetrometer (DCP)

A DCP is a device with a conical tip that is driven into the soil and traditionally used to measure bearing capacity, but has been related to modulus and Texas Triaxial Classification.

Instrumented Vibratory Roller

This system uses an accelerometer on the arm of a vibrating smooth-drum roller to measure displacement of the roller drum. Such a system can potentially measure the uniformity and stiffness properties of a compacted layer.

Automated Proof Rollers

Automated Proof Rollers utilize sensors to automatically measure the rut depth resulting from a proof rolling operation. Such a system potentially can measure uniformity and evaluate the stability/strength properties of a material layer.

Ground Penetrating Radar (GPR)

Ground penetrating radar, or GPR, is a geophysical method that uses radar pulses to image the subsurface, or allow clients to ‘see’ what is underground. In addition, it is a system traditionally used for measuring layer thicknesses. GPR shows promise for evaluating the uniformity of a compacted layer and can potentially measure moisture content of soils and bases.

Falling Weight Deflectometer (FWD)

The FWD (Falling Weight Deflectometer) is used to complete structural testing for pavement rehabilitation projects, research, and pavement structure failure detection. It is used for conventional and deep strength flexible, composite and rigid pavement structures. The FWD applies dynamic loads to the pavement surface, similar in magnitude and duration to that of a single heavy moving wheel load.

Portable Seismic Property Analyzer (PSPA)

Using the PSPA, the average modulus of the exposed surface layers can be estimated within a few seconds in the field. The PSPA consists of two transducers and a source signal packaged into a hand-portable system, which can perform high frequency seismic tests. The source package is also equipped with a transducer for consistency in triggering and for some advanced analysis of the signals. The device is operable from a computer tethered to the

hand-carried transducer unit through a cable that carries operational commands to the PSPA and returns the measured signals to the computer.

Sand Cone Test

The sand cone test measures subgrade or base density. A test hole is hand-excavated in the soil to be tested, and all the material from the hole is saved in a container. The hole is filled with free-flowing sand of a known density, and the volume is determined. To determine the in-place wet density of the soil, the wet mass of the removed material is divided by the volume of the hole. The water content of the material from the hole is determined, and the dry mass of the material and in-place dry density are calculated using the wet mass of the soil, the water content, and the volume of the hole.

Balloon Density Test

The balloon density test measures the density of subgrade and base materials. Similar to the sand cone method, a soil sample is removed, weighed, and dried, then weighed again and the moisture content determined. The volume of the hole is measured by forcing water into a balloon to fill the hole and then reading the volume on a graduated cylinder.

Density Tube Sampler

The density tube sampler measures the in-place density of subgrade materials. A relatively undisturbed soil sample is obtained by driving a thin-walled cylinder of known volume into the soil with a dropping weight. Next, the sample is trimmed even with the ends of the sampling cylinder, providing a sample of known volume. Finally, the moisture content of the sample is measured and dry density computed.

Speedy Moisture Tester (Calcium Carbide)

The Speedy Moisture device measures the moisture content of materials passing the No. 4 sieve. A sample of material is placed in a canister with a calcium carbide reagent. After sealing the chamber, the reagent is mixed with the soil by shaking and agitating. The calcium carbide reacts with moisture in the sample and produces acetylene gas, which in turn creates

pressure in the canister. The pressure created is in direct correlation to the moisture present in the sample. The pressure is read on the instrument's calibrated gauge.

Adek Down Hole Dielectric Probe

The down hole dielectric probe (now distributed through Humboldt) measures the dielectric constant of the soil. Both moisture and density affect the dielectric constant. A simple equation relates the dielectric constant to moisture content. If the density of the material is relatively constant, the impact of density is negligible. This probe's zone of influence is approximately 0.4 liters, according to the supplier.

AquaPro Moisture Probe

The AquaPro probe measures the moisture content of subgrade and base materials. The standard installation requires a hole drilled to the depth desired. Next, soil removed from the hole is mixed with water to form a well-blended mud. The mud is poured back into the hole until full. An access tube is inserted into the hole, and a control box displays readings. The mud used to fill the voids around the access tube must come to equilibrium with the surrounding soil before meaningful measurements can be made. This time frame could be as long as several weeks, and would clearly be impractical for construction-control operations.

Vertek SMR Probe

The Vertek SMR probe measures the moisture content of subgrade and base materials. This probe uses the relationship between the soil dielectric constant and moisture. The manufacturer claims this relationship is not strongly influenced by soil type and resistivity if the dielectric measurement is made above a critical frequency of 30 MHz. Two inner electrode rings on the module determine the soil's moisture content by measuring the frequency shift of a high-frequency excitation signal as it passes through the soil near the surface of the module. According to the manufacturer, the zone of influence is approximately a one-liter volume of soil surrounding the electrodes. This probe attaches to a DCP driving hammer for direct burial.

GeoGauge

The GeoGauge is a non-destructive testing for compacted soils. The device measures the stiffness of the test material through a range of frequencies and potentially could be used to verify the stiffness of a compacted base course. Recently completed NCHRP Project 10-65 recommended the GeoGauge for estimating the modulus of unbound pavement layers. The GeoGauge is about the size of a large hatbox and is shown in Figure 1.1.

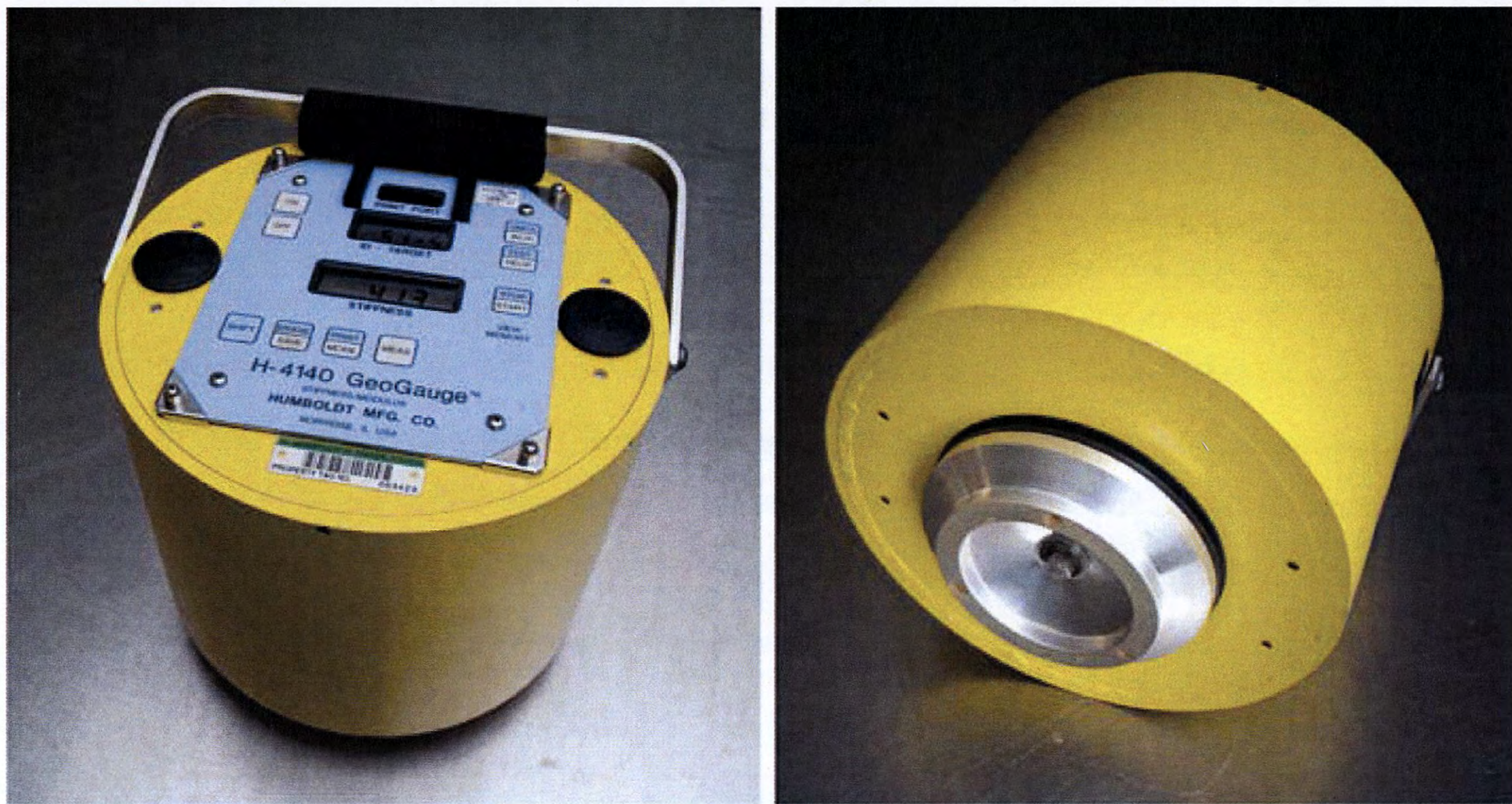

Figure 1.1. Humboldt GeoGauge (Model H-4140)
(<http://www.humboldtmgf.com>).

PROMISING NEW TESTS FOR POTENTIAL USE IN SPECIFICATION

Table 1.4 presents an outline of how specific test types could fit into a flexible base mixture design specification. For most of the properties, existing TxDOT methods should serve adequately. However, a review of the general literature and available test procedures indicates performance-related methods exist which may improve the quality of TxDOT's flexible base specification in two specific areas:

- Amount and activity of fines: the new colorimetric methylene blue test should be further investigated.

- Dry/wet strength and load distribution: recent work relating simpler index tests to resilient modulus and permanent deformation characteristics should be investigated.

Each of these topics is discussed further in the next sections.

Table 1.4. Preliminary Test Properties for Inclusion in Flexible Base QC/QA Specification.

Property/ Parameter	Aggregate Property	Mixture Design	Process Control	Quality Control	Quality Assurance	Acceptance	Pay Adjustment
Aggregate Size Distribution	X	X	X	X	X		
Particle Shape and Surface Texture	X	X					
Amount and Activity of Fines	X	X	X	X	X		
Degradation and Disintegration	X	X					
Contamination	X	X	X	X			
Dry/Wet Strength		X	X				
Load Distribution		X	X	X			
Volume Change		X	X	X			
Permeability		X		X			
Smoothness				X	X	X	X
Segregation				X	X	X	
In-Place Density and Water Content				X	X	X	X

Methylene Blue (Grace Colorimetric Method)

The strength and stiffness properties of flexible base vary widely with varying water content. The moisture sensitivity of materials is one parameter that may not currently be addressed fully within TxDOT. Moisture sensitivity is largely controlled by the quantity and mineralogy of fines. Although current TxDOT specifications do attempt to control the fines through Atterberg limits, concerns exist about the repeatability of the test methods between multiple operators and different laboratories.

The methylene blue value provides an indication of the amount and activity of clay present in an aggregate and may provide an improvement in TxDOT's specification. Specifically, the Grace Methylene Blue Test is a new, rapid, and accurate method for determining the methylene blue value. In contrast to time-consuming titration tests such as AASHTO T 330, the Grace method uses a single addition of methylene blue. Colorimetry determines the concentration of methylene blue not adsorbed. This method reportedly correlates well with AASHTO T330, and results are available in about 10 minutes. The use of scientific instruments for the measurement should also improve the precision of the method. Figure 1.2 presents results from the Grace method employed on control materials created in the lab. The materials were treated with up to six percent clay, using two different clay minerals (bentonite and kaolinite). The results from these preliminary experiments show:

- The MB value correlates well with the known clay content.
- The response of the MB value to increasing clay content drastically varies according to the type of clay mineral present. The MB value increases rapidly with increases in bentonite (a 2:1 clay with high surface area). In comparison, the MB value minimally changes with increases in kaolinite (a 1:1 clay mineral with low surface area). The effect of active clays on the MB value will overshadow the effect of low surface area clays.

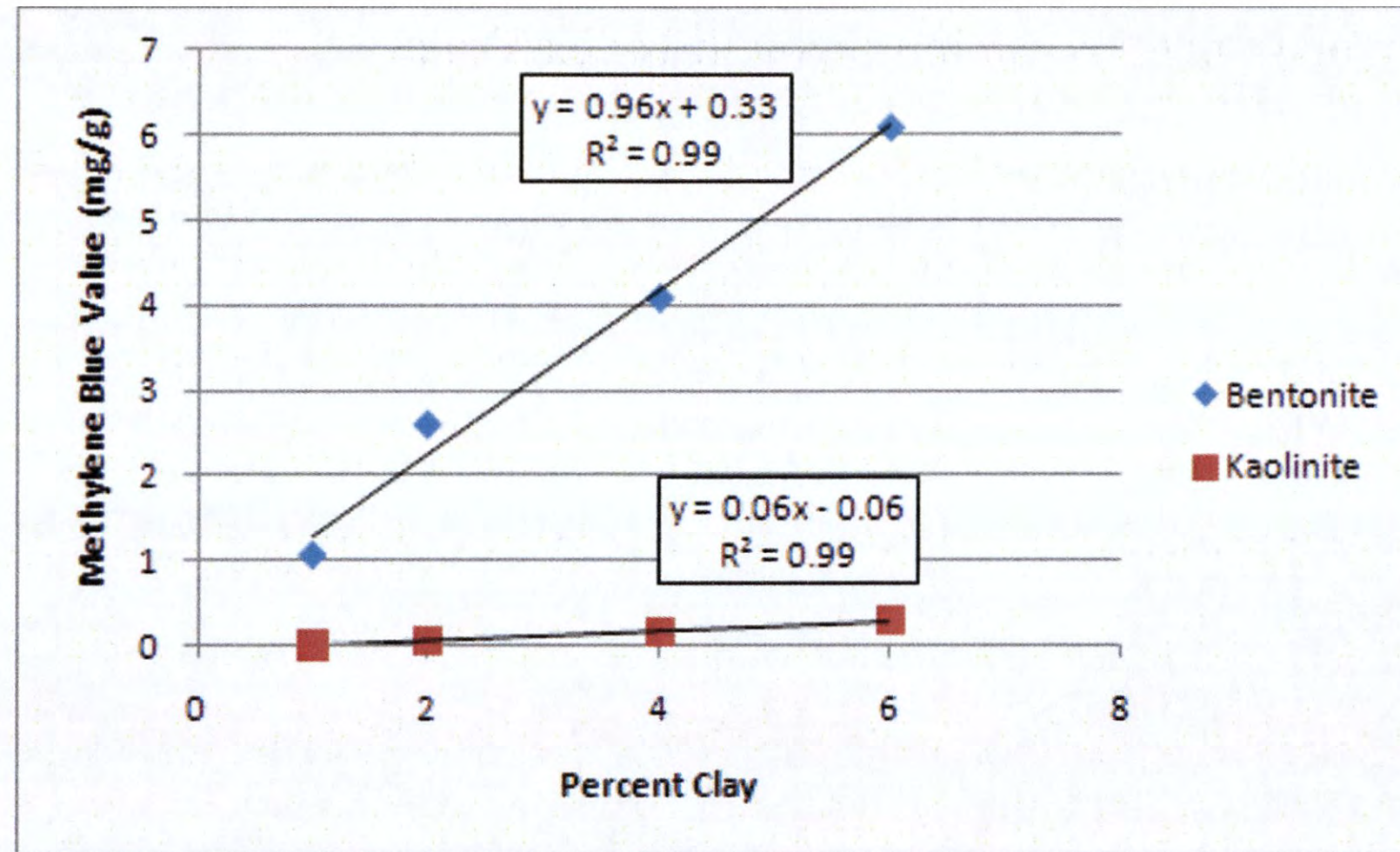

Figure 1.2. Methylene Blue Values with Bentonite and Kaolinite.

Figure 1.3 presents how the methylene blue test could be developed for inclusion into a flexible base QC/QA specification. If successful, the MB test could offer the following benefits:

- Improved test precision.
- Reduced testing time.
- Better relationship to performance than Atterberg limits.
- Reduced risk of base failures due to moisture sensitivity.

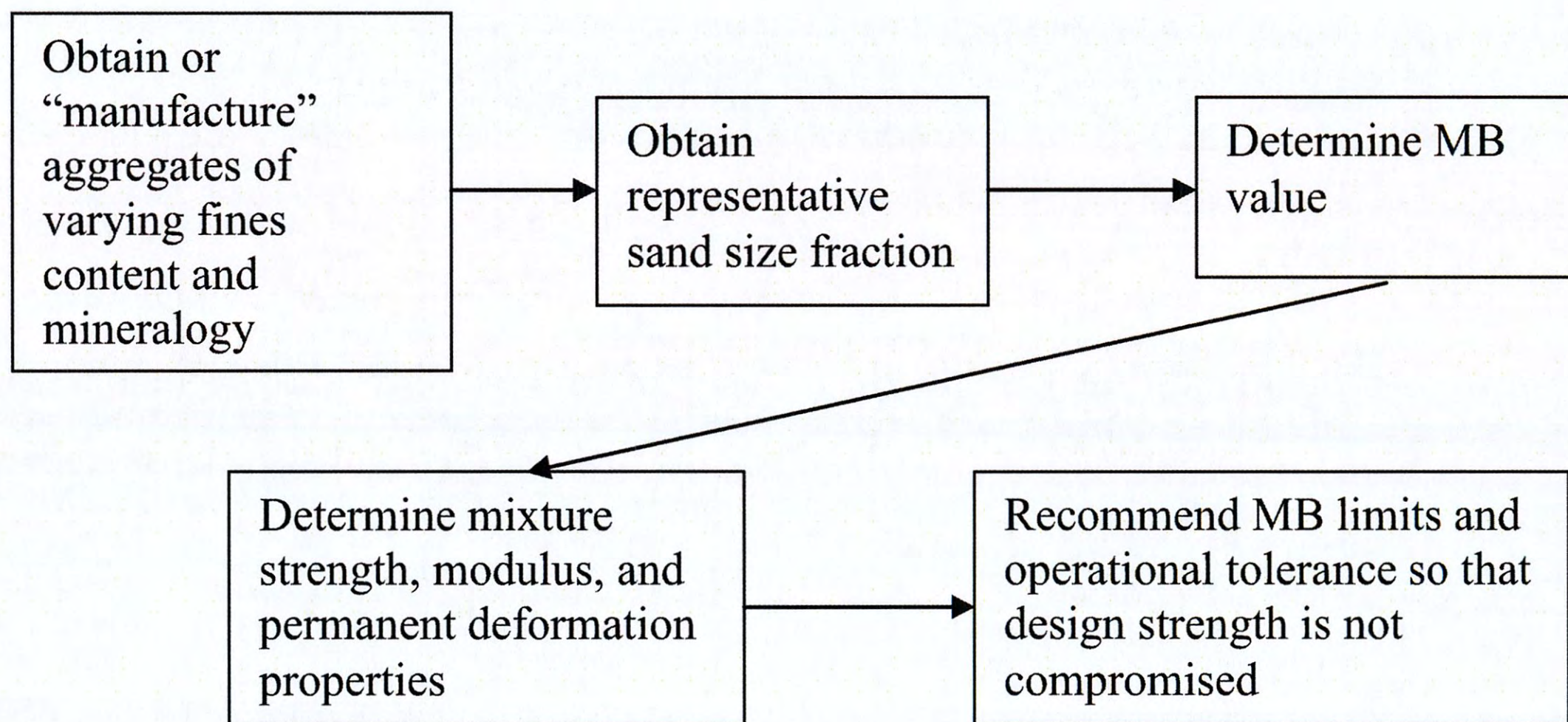

Figure 1.3. Development of Colorimetric Methylene Blue Test for Inclusion in Flexible Base Mixture Design Specification.

Pavement Performance Prediction through Index Tests

While pavements are designed based on modulus, few agencies employ acceptance or specification procedures utilizing stiffness or modulus. The expertise and equipment required to determine modulus and permanent deformation properties historically has been a barrier to establishing a common thread between design and acceptance. However, test equipment and soil mechanics principles may now be developed enough to truly link design and construction with performance indicators that can be feasibly measured in DOT operations.

TxDOT uses elastic modulus in the Texas Flexible Pavement Design System (FPS) to develop pavement designs. While TxDOT largely relies on experience and field FWD measurements for modulus inputs in FPS, numerous approaches exist for predicting modulus based on laboratory data. In one common approach developed for the mechanistic-empirical pavement design guide (MEPDG), the resilient modulus is considered a function of atmospheric pressure, bulk stress, octahedral shear stress, and three curve-fit parameters. Lytton proposed a slightly different model that considers the resilient modulus a function of atmospheric pressure, volumetric water content, matrix suction, saturation, octahedral shear stress, and three curve fit parameters. Either of these models may be suitable to develop the use of index properties as surrogates for the actual resilient modulus test as Figure 1.4 illustrates. With a correlation between elastic and resilient modulus, these index properties could then be used in a quality control/quality assurance (QC/QA) specification to verify the flexible base produced meets the design modulus and perhaps even used to set field target modulus values.

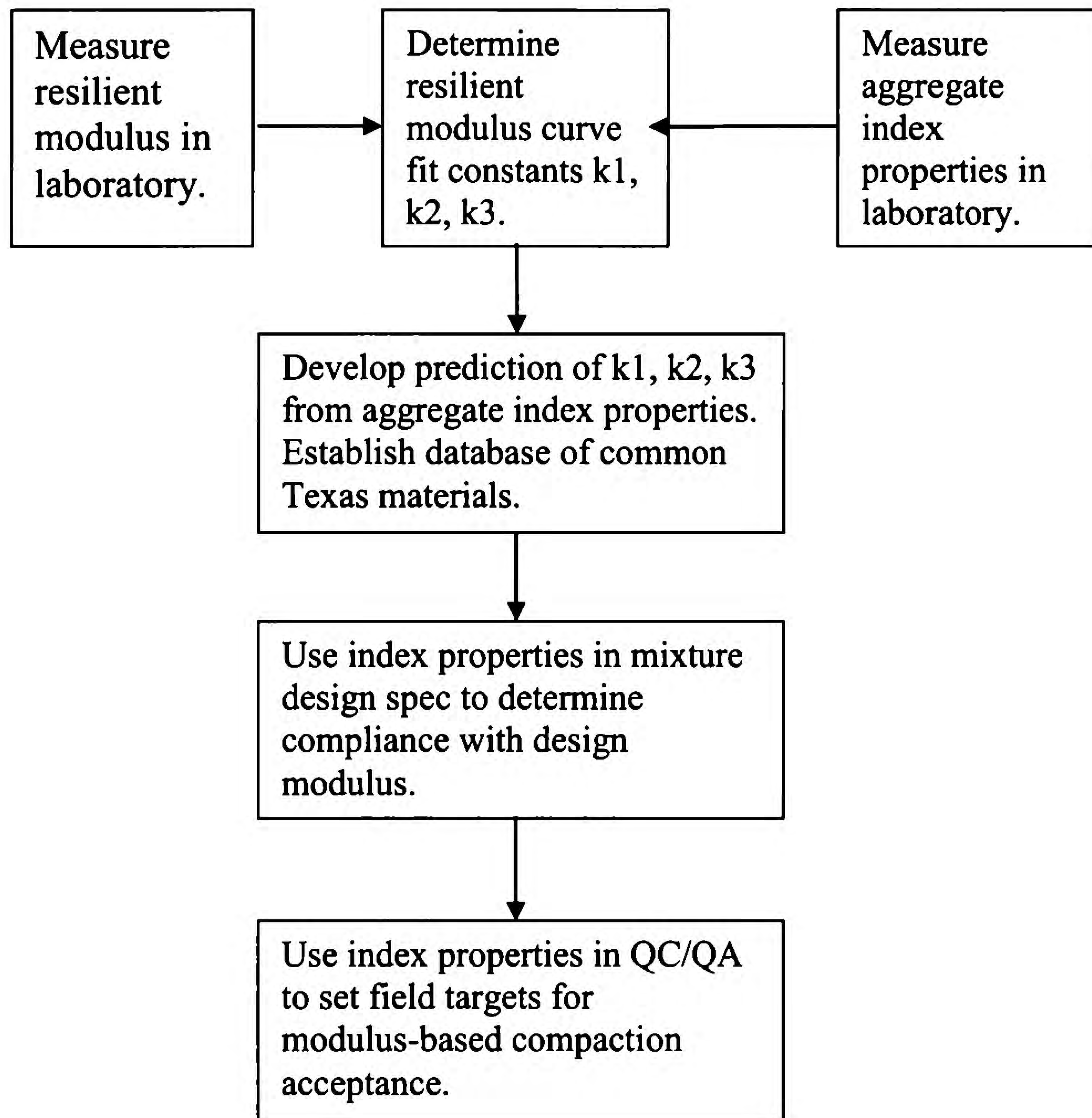

Figure 1.4. Development of Index Tests for Verification of Resilient Modulus.

While resilient modulus is one important parameter for pavement design, to fully predict performance, the permanent deformation properties are also needed. TxDOT currently does not address permanent deformation. The VESYS model or the MEPDG approach may be suitable for consideration in the proposed flexible base mixture design specification. As with the resilient modulus efforts, the goal would be to evaluate if simple index tests can be used to develop permanent deformation characteristics.

CONCLUSIONS

From the general literature review, the most promising approaches that go beyond the current state-of-the practice to consider for inclusion into a flexible base QC/QA specification include the methylene blue value and performance estimates of the base material through index tests. The methylene blue value could help control the amount and activity of fines with perhaps better test precision and turnaround time than the Atterberg limits, while estimating performance through index tests may allow development of a QC/QA program that truly relates to performance measures used in design.

CHAPTER 2.

SUMMARY OF RELEVANT PRIOR TXDOT RESEARCH PROJECTS

OVERVIEW

A review of prior TxDOT-supported research projects indicates the following recommendations and considerations may be suitable for consideration in formulating a flexible base QC/QA specification:

- The compressive strength of rock before crushing is best obtained by using the Schmidt hammer.
- The British Aggregate Crushing Value and Aggregate Impact Value may be suitable for evaluating aggregate degradation. The Fine Aggregate Crushing Test may also be suitable but is more complex to perform.
- Both the fine clay content and mineralogy impact flexible base performance and moisture sensitivity. Since it may be difficult to control mineralogy through specifications, most agencies control the quantity of fines.
- The amount of material passing the No. 200 sieve should be limited to between 5 and 10 percent for optimum engineering performance.
- Resilient modulus and permanent deformation analyses should be mandatory for pavement designs using marginal materials.
- Free-draining bases should be day lighted in construction to avoid trapping water.
- An instrumented roller system is available within TxDOT and may be useful to serve as a proof roller or indicate when to stop compaction.
- The outcome of current and upcoming TxDOT projects on flexible base acceptance testing, total pavement acceptance, and rapid measurement of moisture content for soil and base, could impact the contents of a flexible base QC/QA specification.

The remainder of this chapter provides a review of individual TxDOT-supported research projects.

PROJECT 0-4182: FULL-DEPTH RECYCLING: FIELD PERFORMANCE AND DESIGN GUIDELINES

Project 0-4182 evaluated the performance of full-depth recycling projects. The majority of the projects were performing well; however, several problems were encountered including:

- Longitudinal cracking on sections built over clay subgrade.
- Bonding problems between the pavement surface and the recycled base containing fly-ash as the stabilizer.
- Excessive cracking on some sections containing cement as the stabilizer.

The guidelines shown in Table 2.1 were developed in the project.

Table 2.1. Revised FDR Guidelines (1).

Objective	Base Thickening	Upgrade to Class 1	Super Flexible Base	Stabilized Base
Used When	<ul style="list-style-type: none"> • Existing base is uniform • No widespread structural damage • Existing subgrade is good (> 15 ksi) • Low traffic 	<ul style="list-style-type: none"> • Low-volume roadway • Good subgrade • Moisture not a concern 	<ul style="list-style-type: none"> • High-volume roadway • Moisture a concern • Reasonable subgrade > 10 ksi • Early opening to traffic 	<ul style="list-style-type: none"> • Bridging over poor subgrade • Strengthening required • Low-quality variable base • High rainfall • Early opening to traffic
Selection of Stabilizer	No stabilizer Add new flex base only	Full Texas triaxial evaluation 117-E 1) 45 psi at 0 psi confining 2) 175 psi at 15 psi confining	Full Texas triaxial evaluation 117-E 1) 60 psi at 0 psi confining 2) 225 psi at 15 psi confining 3) < 0.5% gain in moisture over molding moisture after 10 days capillary	7-day moist cure, then 1) UCS > 300 psi 2) Dielectric < 10 after 10 days capillary rise 3) 85% retained strength
FPS 19 Design Recommendations*	Lowest of 70 ksi or 4 times subgrade modulus	100 ksi	150 ksi	200 ksi
Comments	1) New base should be of higher or equal quality than existing 2) Use Bomag to blend existing and new			1) Avoid cutting into subgrade, add new base where needed 2) Consider grids and flex base overlay where high PI soils exist (PI > 35) 3) If lab strength > 350 psi then use microcracking

*Conservative value: District may wish to change this value based on long-term performance studies

PROJECT 0-5223: THE EFFECTS OF PULVERIZATION ON DESIGN PROCEDURES

Project 0-5223 evaluated how particle breakdown during field pulverization and mixing operations impacts FDR designs. The majority of particle breakdown occurs with the first pass of the mixer, and on average 10 percent of the coarse aggregates (retained on the No. 4 sieve) are

crushed to fine sand. The British Aggregate Crushing Value (ACV) was recommended to determine which aggregates were excessively soft. Adhering to target moisture and stabilizer value contents was cited as the key element to success of a FDR project. Adding high-quality virgin aggregate was recommended as a means to preserve the desired final gradation. This project suggested the following for improving FDR processes (2):

- Use ground-penetrating radar and falling weight deflectometer to survey the project and aid in selecting sampling locations.
- Use gradations with approximately 15 percent fine sand (passing the No. 40 sieve and retained on the No. 200 sieve).
- Limit the amount passing the No. 200 sieve to less than 10 percent.
- Use the ACV to predict the additional amount of fine sand that will be generated by field mixing operations.
- Blend materials sampled from different sites along the project to obtain materials for one mix design.
- Reduce the amount of gravel (retained on the No. 4 sieve) by 8 percent, and increase the amount of fine sand by 8 percent, if ACV tests are not available.
- Cure lab moisture-density specimens for 24 hours, then determine the lab seismic modulus and unconfined compressive strength (UCS). If after 24 hours, the UCS is less than 150 psi for cement treatment or less than 75 psi for fly ash treatment, the compatibility of the additive with the base course material is in doubt.
- For cement-stabilized projects, the retained-strength ratio after a four-hour soak can be used to evaluate moisture susceptibility.
- For projects using fly-ash, an accelerated test program involving only six days of bench top curing prior to UCS determination, and targeting 200 psi strength, may provide a method to accelerate the mix design process.
- Asphalt-bound materials should be milled prior to mixing into the existing base.
- Moisture content prior to compaction should be included as a quality control item. “Slush rolling” should not be permitted.
- Opening to traffic should be dictated by establishment of some minimum strength or stiffness.

PROJECT 0-5797: DESIGN, CONSTRUCTABILITY REVIEW, AND PERFORMANCE OF DUAL BASE STABILIZER APPLICATIONS

Project 0-5797 evaluated base stabilization employing dual treatments (an asphalt emulsion combined with a calcium-based stabilizer). This approach typically produces mixes with good strength, moisture susceptibility, and flexibility characteristics. This project provided the following recommendations and observations for dual-base stabilizer projects (3):

- Indirect tensile strength (ITS) should be used as the main strength criteria.
- The retained ITS after moisture conditioning should be used as the moisture susceptibility test.
- The new high-shear mixer proposed for use in mixing emulsion-treated materials resulted in increased strengths as compared to hand mixing.
- Specimens compacted with a gyratory compactor had higher strengths and moduli values than specimens compacted with Tex-113-E (impact hammer) compaction.
- The temperature at which the material is cured after mixing but prior to compaction does not impact results as long as the curing temperature is at least 70°F.
- Specimens should be cured for two days at 140°F.

To date, all TxDOT dual-base stabilizer projects have been constructed under One-Time Use Special specifications.

PROJECT 0-5562: GUIDELINES FOR USING LOCAL MATERIALS FOR ROADWAY BASE AND SUBBASE

In Project 0-5562 researchers investigated the use of locally-available, low quality base aggregates in place of importing a high quality flexible base. Attaining TxDOT Grade 1 classification was the target (4). The research team determined that modifying the marginal materials with lime or one percent cement typically achieved Grade 1 strengths. Additionally, the researchers noted that gradation modification alone did not improve the quality of the materials. For bases thinner than 12 inches, using “local materials” without modification is not prudent. This project recommended that if the base is thicker than 12 inches, the use of marginal local materials as a subbase should be explored.

For pavement design using marginal materials, this project suggested a resilient modulus and permanent deformation analysis should be mandatory, and either the VESYS or TxIntPave programs should be used to validate the design (4). Finally, the economics of using a low-quality base must be evaluated. In some cases, importing a high-quality base may be more economical than using local, low-quality materials.

PROJECT 0-4358: MATERIALS, SPECIFICATIONS, AND CONSTRUCTION TECHNIQUES FOR HIGH PERFORMANCE FLEXIBLE BASES

Project 0-4358 investigated the concept of a “heavy duty, high quality” flexible base. TxDOT, other department of transportation (DOT) agencies, and research specifications were reviewed. Laboratory and field tests were performed on several bases meeting a proposed “Item 245: Heavy Duty Aggregate Base” specification. In the initial specification and literature review, researchers found (5):

- TxDOT Item 247 was the only state DOT flexible base specification out of nine examined that did not limit fines content (passing No. 200). Other agencies typically limit the amount passing the No. 200 sieve to less than 10 percent.
- NCHRP Project 4-23 suggested an upper limit of 10 percent on the material passing the No. 200 sieve and that triaxial strengths should be determined at 5 and 15 psi lateral pressure. Several studies indicated that strength testing with no lateral confinement can eliminate high quality material.
- Some agencies require a trial section, which may help identify if the field optimum water content significantly differs from the lab optimum.
- While some specifications are more restrictive on equipment for spreading and mixing, no specifications contain formal segregation/uniformity measures.
- The large stone experiments constructed by TxDOT’s Fort Worth District (6) showed that large stone, low fines base exhibited increasing field modulus with time while the “regular” base exhibited a decreasing field modulus with time. Table 2.2 and Figure 2.1 illustrate the materials used and the field FWD measurement.

Table 2.2. Base Materials Used on FM 1810 in Project 7-3931 (5).

Parameter Description		Section 1: Station 1 + 000 to Station 1 + 900 (meter)		Section 2: Station 4 + 000 to Station 4 + 800 (meter)		
Gradation		Proposed Large Stone Gradation		Regular Type A, Grade 6		
English	Metric (mm)	Specification	Constructed	Specification	Lower limit	Upper limit
4"	100	< 100	100	-	-	-
3"	75	80 - 100	99	-	-	-
	45	50 - 75	70	95 - 100	95	100
3/2"	37.5	-	-	-	-	-
	22.4	-	-	65 - 95	65	95
3/8"	9.5	15 - 40	54	-	-	-
No. 4	4.75	-	-	25 - 60	25	60
No. 40	0.425	0 - 10	9	20 - 35	20	35
No. 200	0.075	-	-	-	18	28
Fines	PI	Max. 12 Min. 0	NP	Max. 12 Min. 4	6	6
	LL	Max. 45	NP	Max. 45	22	22
Wet Ball Mill, %		Max. 50	-	Max. 50	-	-
Increase in % fines (No. 40)		Max. 20	-	Max. 20	-	-
Texas Triaxial Class		-	1.0	-	1.9	3.5
Strength (psi) at 0 psi lateral pressure		-	82.7	-	56.5	9.0
Strength (psi) at 15 psi lateral pressure		-	253.4	-	158.2	90.9
Maximum Dry Density, MDD (pcf)		-	138.1	-	126.3	130.2
Optimum Moisture Content, % OMC		-	6.4	-	5.9	4.9

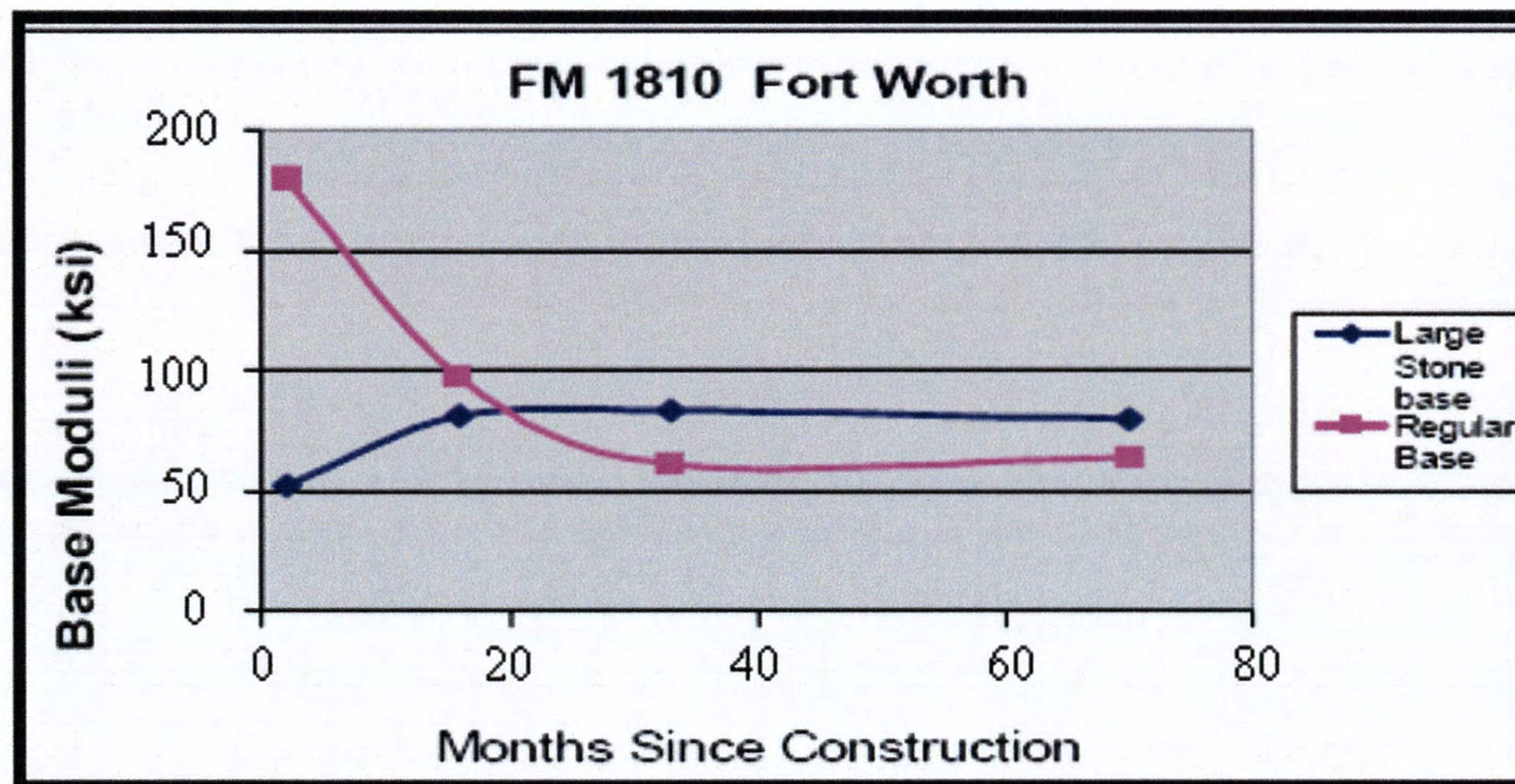

Figure 2.1. Field FWD Modulus of Bases Constructed under Project 7-3931 (7).

Project 0-4358 also systematically evaluated the influence of gradation, and specifically the amount passing the No. 200 sieve, on moisture susceptibility, triaxial strength, resilient modulus, and permanent deformation. The results indicated that for optimum engineering properties the amount passing the No. 200 sieve should be between 5 and 10 percent (8). Further work in Project 0-4358 suggested that tests such as resilient modulus may not be able to distinguish between the standard TxDOT bases and the “heavy duty” bases whereas moisture susceptibility tests could distinguish among the materials (9). Additionally, mineralogical analyses of two common Texas bases and two “heavy duty” bases found that the quantity, type, and crystalline nature of the fine clay fraction likely explains the difference in performance particularly in respect to moisture sensitivity. The moisture sensitive bases contained larger percentages of fine clays, where the fine clays were predominately expansive minerals with poor crystallinity. Because regulating the type of fines could be problematic, the research recommended limiting the fines quantity (7).

Project 0-4358 concluded:

- Not all fines are created equal. A base could have high fines content of “good” mineralogy and not be moisture susceptible. Conversely, a small percentage of swelling clay minerals in the fines fraction can make a material moisture susceptible and poor performing.
- Current Texas bases perform well in many parts of the state, but in some conditions moisture susceptibility should be addressed. The proposed “Item 245” base attempted to address historical performance issues with some Texas bases by incorporating restrictions on the minus No. 200 fraction, restricting the fines activity through lowered Atterberg Limit thresholds, and increasing the required strength at 15 psi lateral confinement. Table 2.3 presents the proposed heavy-duty aggregate base specification.
- Bases meeting the heavy-duty requirement tend to be free draining and should be daylighted in the field to avoid trapping water.

**Table 2.3. Heavy-Duty Base Material Proposed
in Project 0-4358 (10).**

Property	Test Method	Grade 1
Master Gradation (Percent Retained)		
1 ¼ in.	Tex-110-E	0
1 ½ in.		0-15
¾ in.		10-35
½ in.		35-55
No. 4		50-75
No. 40		70-90
No. 200		88-98
Liquid Limit ¹	Tex-104-E	≤ 25
Plasticity Index ¹	Tex-106-E	≤ 8
Wet Ball Mill, percent ^{2,3}	Tex-116-E	≤ 30
Max. Increase Passing No. 40, percent	Tex-116-E	≤ 12
Deleterious Materials, percent	Tex-413-E	≤ 1.5
Confined Compressive Strength (psi)(@15 psi Confining)	Tex-144-E	> 225
Dielectric Value	Tex-144-E	Report
Initial Seismic Modulus (ksi)	Tex-149-E	Report

PROJECT 0-5268: ROLE OF COARSE AGGREGATE POINT AND MASS STRENGTH ON RESISTANCE TO LOAD IN HMA

Project 0-5268 investigated aggregate fracture caused by stress concentrations at coarse aggregate contact points (11). Although focused on aggregates for hot-mix asphalt, some of the findings are useful for this project:

- The Schmidt hammer provides the most appropriate test for strength of the bulk rock before crushing.
- The aggregate crushing value and its surrogates correlated well with performance.
- Of the mixtures evaluated, the coarse mixes (Permeable Friction Coarse and Coarse Matrix High Binder-C) experienced the most aggregate degradation during compaction, while the finer mixes (Superpave-C and Type D) experienced notably less degradation.

The permeable friction course (PFC) mixture, a coarse mix with high air voids, has higher internal stresses and should use aggregates with higher strengths.

PROJECT 0-4774: NEW TECHNOLOGIES FOR MEASURING PAVEMENT QUALITY

In Project 0-4774 researchers investigated potential new technologies for pavement acceptance. A key point of the project was to see if any off-the-shelf technologies existed that could replace the nuclear density gauge. Two non-nuclear moisture probes were identified as potentially viable means to measure water content of soils and bases in the field for moisture control. These devices were the AquaPro and Vertek moisture probe. At the time, no devices existed that could completely replace the nuclear density gauge (12).

A key outcome from this project was development of an instrumented roller system that could provide full-coverage evaluation of a pavement section. The system measures the amplitude of a vibratory roller's drum, where higher drum amplitude indicates a stiffer pavement section. Further work revealed the roller drum response is dominated by the influence of the "foundation" layer, typically at least 12 inches below the test surface (13).

CURRENT TXDOT PROJECTS

Several current TxDOT projects may provide input or room for coordination with this project. Project 0-6587, "Flexible Base Acceptance Testing," is evaluating alternative methods to the nuclear density gauge for flexible pavement acceptance testing, and Project 0-6005, "Developing a Testing Device for Total Pavements Acceptance," is working on developing a total pavement acceptance device. Upcoming TxDOT Project 0-6676, "Rapid Field Detection of Moisture Content for Base and Subgrade," will specifically investigate rapid field detection of moisture content for base and subgrade. The outcome of each of these projects could influence the contents and/or methods of a flexible base QC/QA specification.

CHAPTER 3.

SYNOPSIS OF RELEVANT NON-TXDOT FLEXIBLE BASE SPECIFICATIONS

OVERVIEW

TTI researchers studied the granular base specifications of 17 selected highway agencies including U.S. federal agencies, state departments of transportation, and international agencies. Table 3.1 summarizes the findings. This endeavor consisted mainly of a search of information available on the internet. Most of the specifications are easy to follow where one can glean important information; others are more difficult to follow. Thus, some cells in Table 3.1 are blank.

The main goal of this effort was to search for new, innovative methods (e.g., sampling, testing, criteria, and/or type of specification) for assuring high-quality base materials and construction of unbound base layers. Of particular interest were those methods used for process control, acceptance testing, quality control and quality assurance, and pay factors. Based on the findings of this relatively small effort, only a few highway specifying agencies use QC/QA-type specifications and/or pay factors for granular base materials and construction.

All of the agencies reviewed use traditional basic requirements for their granular base materials. These essentially include: aggregate gradation, abrasion, deleterious materials, soundness (either $MgSO_4$ or $NaSO_4$), Atterberg limits, crushed particles, and flat/elongated particles. Other less frequent materials requirements identified include R-Value, California bearing ratio (CBR), modulus, durability index, sand equivalent, linear shrinkage, petrographic analysis (e.g., ASTM C295), water absorption, etc. Infrequent construction requirements observed in this effort include: dynamic cone penetrometer, proof rolling, automatic finishing machine, and six-inch maximum lift thickness. Application of these test methods and the acceptable values for the various tests generally depend on the class level of the specific base material.

Table 3.1. Types of Tests and Specifications for Granular Base Materials Used by Selected Highway Specifying Agencies.

State DOT	Coarse Aggr. Tests	Fine Aggr. Tests	Laboratory Tests	Field Tests	Pay Factor	QC/QA Type Spec.	Source of Information
Federal							
AASHTO M 147	Gradation, LA Abrasion	- #200 not >2/3 of - No. 40, LL ≤ 25, PI ≤ 6, gradation, no organics/clay	None found	Moisture content ≤ optimum for density, density	None found	No	AASHTO Standard Specifications
WFL - FHWA	Gradation, durability index, fractured faces	Atterberg Limits, Gradation	Moisture-density	Density, moisture AASHTO T 180	Yes – based on PWL	No	Federal Lands Highway specs
FAA	Gradation ² , LA Abrasion, crushed faces, NaSO ₄ soundness	- #200 not >1/2 of - No. 40, LL ≤ 25, PI ≤ 6, Gradation, If frost: max 3% finer than 0.02 mm & # 200 0% to 8%	Moisture-Density- ASTM D 698	Density (acceptance), smoothness & accuracy of grade W & crown, thickness, no damage due to rain/freeze, moisture content	None found	No	
Minnesota	Gradation, LA abrasion, debris/organics, crushed particles, MgSO ₄ soundness, shale content	Atterberg Limits, gradation, hydrometer	Standard Proctor, One-Point Standard Proctor, or Estimated Opt. Moist. Content	Density, dynamic cone penetrometer w/ specs, Lt. Wt. Deflectometer (process control); gradation (acceptance)	Yes – based on certain sieves	No – Lt. Wt. Deflectometer is termed QA but not listed in standard spec	Mn/DOT Grading & Base Manual, Standard Specs.
Florida	Gradation, organics/clay, crushed faces, NaSO ₄ soundness	Atterberg Limits, gradation, sand equivalent	Modified Proctor, (also used for process control), Limerock Bearing Ratio	Modified Proctor, Density, Smoothness, Thickness, (acceptance)	Yes – based on average thickness	Yes – quality control/ department verification (QC/DV)	Std Specs for Road & Bridge Const.

Table 3.1. Types of Tests and Specifications for Granular Base Materials Used by Selected Highway Specifying Agencies (continued).

State DOT	Coarse Aggr. Tests	Fine Aggr. Tests	Laboratory Tests	Field Tests	Pay Factor	QC/QA Type Spec.	Source of Information
Virginia	Gradation, LA Abrasion, crushed particles, MgSO ₄ soundness or freeze-thaw, deleterious, flat/elongated	Atterberg Limits, gradation, organics, deleterious, flat/elongated	Optimum moisture, CBR	CBR (acceptance)	Use point system for Atterberg Limits and gradation; >25 pts remove & replace	No	Std Specs for Road & Bridge Const.
Arizona	Gradation, LA Abrasion, crushed particles, organics, deleterious, soundness	Atterberg Limits, gradation	Proctor methods,	6-inch max/lift, segregation free	None found	No	AZ Standard Specs for Roads & Bridges, Materials Testing Manual
California	Gradation, LA Abrasion, organics, deleterious, resistance (R-value), durability index	Sand equivalent		Gradation, sand equivalent Density, thickness (acceptance)	Gradation, sand equivalent	No	1999 2001 Std Specifications
Pennsylvania	Gradation, LA abrasion, deleterious, clay, petrographic analysis (ASTM C 295), crushed particles, max absorption-3-3.5%	Strength Ratio, Soundness, Fineness Mod.	?	?	?	?	PennDOT website. Difficult to extract information

**Table 3.1. Types of Tests and Specifications for Granular Base Materials Used by Selected Highway Specifying Agencies
(continued).**

State DOT	Coarse Aggr. Tests	Fine Aggr. Tests	Laboratory Tests	Field Tests	Pay Factor	QC/QA Type Spec.	Source of Information
Georgia	Gradation, abrasion, soundness, petrographic analysis-ASTM C 295, deleterious, with limerock bearing ratio >100 (FL DOT FM 5-515) & CO ₃ > 90%	% - #200, % clay, Δ volume of - #10, #10 a key sieve, sand equivalent	Gradation, volume change, Atterberg Limits for acceptance	Gradation, volume change, Atterberg Limits for acceptance	Not found	No	Georgia DOT Standard Specifications Construction of Transportation Systems
Arkansas	Gradation, LA Abrasion, crushed faces	Atterberg Limits, gradation, Class 1 & 2 #200 ≤ ¾ #40 size, Class 3-8 #200 ≤ ⅔ #40 and LL ≤ 25	AASHTO T 99, Method A & C, AASHTO T 180	Density (98% of max lab density), moisture content, PI, thickness (acceptance) No segregation, max 6" lifts (8" if approved), gradation	Not found	Yes – Section 306 of Spec	Section 303 of state spec
Louisiana	Gradation, deleterious	Atterberg Limits	?	Density, Class I requires automatic finishing machine, requires certified base course technician at plant, visual segregation	Density	No	Stone Base 1003.01 & 1003.03(b)
New Mexico	Gradation, aggregate index, deleterious, crushed faces	Atterberg Limits, gradation, sand equivalent	R-Value & Expansion Pressure - AASHTO T190	Gradation, moist. cont, Density of top 6" - max 6" lifts, proof-roll subgr w/ 27-ton roller & correct soft areas (acceptance)	Surface tolerance ½ inch in 10 ft. Deficient depth >12 inches can be accepted with reduced pay	Yes – Section 901, Quality Control/ Quality Assurance (printed)	Std Specs for Road & Bridge Const.

Table 3.1. Types of Tests and Specifications for Granular Base Materials Used by Selected Highway Specifying Agencies (continued).

State DOT	Coarse Aggr. Tests	Fine Aggr. Tests	Laboratory Tests	Field Tests	Pay Factor	QC/QA Type Spec.	Source of Information
Oklahoma	Gradation, LA Abrasion, fractured faces, deleterious, soft particles-OHD L-38, durability index-AASHTO T-210	Atterberg Limits, gradation, durability index-AASHTO T-210	AASHTO T-180, Method D	Gradation, Thickness, Density and Moisture Content by nuclear (acceptance)	Not found	Yes	Construction Engineering Standards, Specifications, Materials and Testing
International							
United Kingdom	Gradation, LA Abrasion, MgSO ₄ soundness fractured faces, deleterious	Atterberg Limits (PI<6)	Compressive strength, immediate bearing index	CBR, density, moisture content	None found	No	Manual of Contract Documents for Highway Works, Vol. 1, Series 800
Australia	May include: Gradation, LA Abrasion, NaSO ₄ soundness, crush value, fractured faces, flakiness, wet-dry strength, clay lumps-friable particles, degradation factor, ball mill	Atterberg Limits, gradation, linear shrinkage	Resilient Mod, deformation, LA abrasion, repeated-load triaxial deformation	Density, moisture content, CBR is sometimes used	Not found	No Performance Based	2003 Austroads Report on Perf-Based Specs for Unbound Granular Materials
Alberta, Canada	Gradation, fractured faces, LA abrasion, flakiness, deleterious	Gradation, Atterberg Limits	Gradation, density, fracture, moisture content (acceptance)	QC Tests: Gradation, deleterious, blending, dry strength, PI, fracture, abrasion, flakiness, (acceptance)	Yes, gradation & fractures	Yes	Province specification

DISCUSSION OF OTHER AGENCY SPECIFICATIONS

The Minnesota DOT (MnDOT) specification is unique in that it allows use of the DCP and a lightweight deflectometer (LWD). MnDOT has been studying the DCP and LWD for more than 18 and 13 years, respectively, and has concluded that these are excellent and convenient tools for assuring high-quality base layers. Their specification lists maximum allowable penetration depths (or penetration index values) for the DCP, which depends on the class of the base. The LWD is a lightweight, portable, hand-operated device that determines the stiffness of unbound base layers during construction by measuring the deflection under an applied impact load. The LWD system measures deflection of a compacted layer that is impacted by a falling weight and estimates a modulus value that is based on the force required to generate a given deflection for that soil type. Information on MnDOT's use of the LWD is available at http://www.dot.state.mn.us/materials/research_lwd.html. MnDOT believes that the LWD:

- Represents the ability of a pavement to handle traffic loads better than density.
- Provides direct verification of soil values used during pavement design.
- Provides quick results with no delay of construction.
- Requires no laboratory testing, so inspector stays at construction site.
- Is safer, since construction inspectors spend less time near moving traffic.

Five of the 17 agencies use various forms of QC/QA specifications. These were of particular interest to the research team, because one goal of this research project is to develop QC/QA specifications for granular base materials and construction for TxDOT consideration. Pertinent elements of these QC/QA specifications may be used by the project team during the development of this proposed specification.

The Virginia DOT uses payment adjustment points in their payment adjustment system for acceptance of aggregate base materials. Basically, the penalties have increasing severity in order of deviations from the following: plasticity index, No. 200 sieve, No. 40 sieve, liquid limit, and the other sieve sizes. In other words, deviations from the PI incur more severe penalties than deviations from certain sieve size requirements. Charts are provided in the specification, which precisely describes the payment adjustment processes. If the total

adjustment for the lot is more than 25 points, the failing material must be removed from the roadway. If the total adjustment is 25 points or less and the contractor does not elect to remove and replace the material, the unit price for the material will be reduced by 1 percent for each adjustment point. The payment adjustment is applied to the total tonnage that the sample(s) represented. Further, when the quantity of any one type of material furnished for a project exceeds 4000 tons, the variability of the total quantity furnished will be determined on the basis of the standard deviation for each sieve size.

CHAPTER 4. HISTORICAL FINDINGS OF RECYCLED MATERIALS USE IN FLEXIBLE BASE

OVERVIEW

The literature suggests that reclaimed asphalt pavement (RAP) and/or reclaimed concrete aggregate (RCA) are viable materials for blending with granular base material and capable of providing adequate performance. However, because of significant differences in various virgin aggregates as well as RAP and RCA, testing should be performed to verify that the blended materials meet the general specifications as well as the specific requirements for the project. This chapter explores historical information pertinent to identifying the impact of RAP and RCA on flexible base mixture properties and performance.

RECLAIMED ASPHALT PAVEMENT

It is an accepted fact that the gradation and properties of granular materials have significant impacts on the performance of compacted base layers. Therefore, when one blends reclaimed asphalt pavement with dense graded aggregate base course (DGABC) to produce granular base, the subsequent changes in materials properties will affect performance. The definition of performance may include, for example, serviceability, density, shear strength, stiffness, durability, frost susceptibility, permeability, as well as resistance to permanent deformation and/or cracking. A few recent studies have addressed most of these issues.

In their *User Guidelines for Waste and Byproduct Materials in Pavement Construction*, the FHWA (14) maintains that RAP, which has been properly processed and blended with DGABC, has demonstrated satisfactory performance as granular road base for more than 20 years and is now considered standard practice in many areas. At least 13 state DOTs (Arizona, Illinois, Louisiana, Maine, Nebraska, New Hampshire, North Dakota, Oregon, Rhode Island, South Dakota, Texas, Virginia, and Wisconsin) have used RAP as aggregate in base course. At least four state agencies (Alaska, New York, Ohio, and Utah) have used RAP as unbound aggregate in subbase, and at least two states (California and Vermont) have experience with RAP use in stabilized base course (15). Overall, the performance of RAP, as a granular base or subbase aggregate, or as an additive to granular base or subbase, has been described as satisfactory to excellent.

Some of the positive features of RAP aggregates that have been properly incorporated into granular base applications include adequate bearing capacity, good drainage characteristics, and very good durability. However, RAP that is not properly processed or blended to design specification requirements may result in poor pavement performance. Generally speaking, increasing the RAP content generates a decrease in the bearing capacity of the granular base. Yuan et al. (16) evaluated 80 untreated and cement-treated mixtures consisting of RAP from six stockpiles and granular materials from eight stockpiles in Texas to develop a realistic mix design procedure for high-RAP-content mixtures used in roadway base course construction. Basically, they found that RAP content in a mix strongly impacts strength, modulus, and durability of the mix.

Saeed (17) listed physical, chemical, and mechanical properties of recycled aggregate particles that he considered important when blending with DGABC (Table 4.1). He also tabulated the relevance of the bulk properties of recycled material that affect an aggregate layer in a flexible pavement (Table 4.2).

Table 4.1. Recycled Aggregate Particle Properties that Influence Pavement Performance (17).

Physical properties	Chemical properties	Mechanical properties
Particle gradation and shape (max/min sizes) Particle surface texture Pore structure, absorption, porosity Permeability (hydraulic properties) Specific gravity Thermal properties Volume change (in wetting & drying) Freezing/thawing resistance Deleterious substances	Solubility Base exchange Surface charge Chemical reactivity (resistance to attack by chemicals, chemical compound reactivity, oxidation and hydration reactivity, organic material reactivity) Chloride content pH-level	Particle strength Particle stiffness Wear resistance Resistance to degradation Particle shape of abraded fragments

Table 4.2. Relevance of Recycled Material Properties for Various Applications (17).

Mass Property of Material	Relevance of Mass Property to the Use of Recycled Material as					
	Structural Layer	Construction Platform	Drainage Layer	Frost Blanket	Control Pumping	Select Fill
Shear Strength	Y	Y	N	N	N	N
California Bearing Ratio (CBR)	Y	Y	N	N	N	Y
Cohesion & Angle of Internal Friction	Y	N	N	N	N	N
Resilient or Compressive Modulus	Y	Y	Y	Y	Y	Y
Density	Y	Y	N	Y	Y	Y
Permeability	N	N	Y	Y	Y	N
Frost Resistance	Y	N	Y	Y	N	Y
Durability Index	Y	N	Y	Y	Y	N
Resistance to moisture damage	Y	N	N	N	N	N

Y: Relevant; N: Not relevant

Impact of RAP on Flexible Base Characteristics

Gradation

The FHWA (14) contends that gradation for milled RAP is governed by the spacing of the teeth and forward speed of the pulverizing unit. Wider tooth spacing and higher speed result in larger particle sizes and coarser gradation. RAP can be readily processed to satisfy gradation requirements for granular base and subbase specifications.

Yuan et al. (16) concluded that in an aggregate-RAP mixture, the percentage of particles passing the No. 40 sieve, in general, and passing the No. 200 sieve, in particular, significantly impact strength and modulus. Since the lack of these particles in Texas RAP is common, RAP mixed with granular base (including recycled base) materials with higher fines content can improve the quality of the mixes. However, particle size distribution of coarse aggregate has a minor impact on strength and modulus of cement-treated RAP mixes.

Compacted Density

Apparently, due to the coating of asphalt cement on RAP aggregate, which inhibits compaction, the compacted density of blended granular material tends to decrease with increasing RAP content (18).

Optimum Moisture Content

For various blends of RAP with base aggregate, researchers found that an increase in RAP content typically yielded a decrease in maximum dry density (MDD) (17) and optimum moisture content (OMC) values (16; 19-22) (Figure 4.1). Aggregate particles and conglomerates in the RAP were partially encased in asphalt, which decreased the specific gravity. Apparently, the partial asphalt coating reduced the aggregate water absorption potential and inter-particle friction, leading to a reduction in the required water to achieve MDD.

Hanks and Magni (23) reported that OMC for aggregate-RAP blends is higher than for conventional granular material. This was particularly true for RAP from pulverizing operations and was likely due to higher fines content and the absorptive capacity of these fines. Normally, asphalt acts like fluid in an aggregate mix, which should lower the OMC.

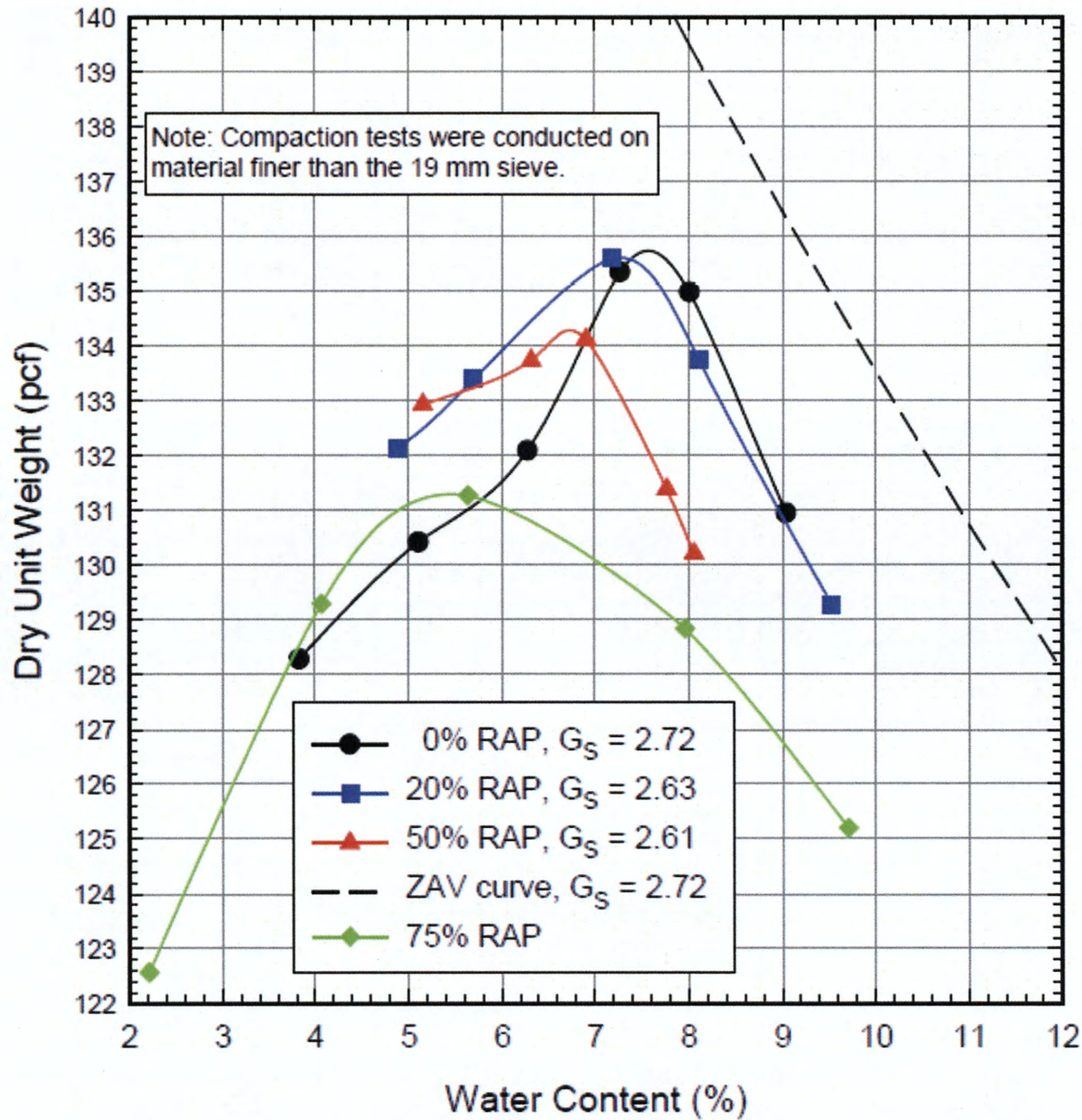

Figure 4.1. Modified Proctor Compaction Curves for Pit Run Blends (20).

Resilient Modulus

Three studies (19, 21, 24) indicated that, even though resilient modulus (M_R) of base aggregate with RAP increased with an increase in RAP content (see Figure 4.2), the accumulated permanent deformation from the cyclic triaxial test also increases. Tests were apparently performed at room temperature using repeated cycles of axial stress applied to specimens at a given confining pressure (generally, AASHTO T 292). Each cycle was 1 second in duration, consisting of a 0.1-second haversine pulse followed by a 0.9-second rest period.

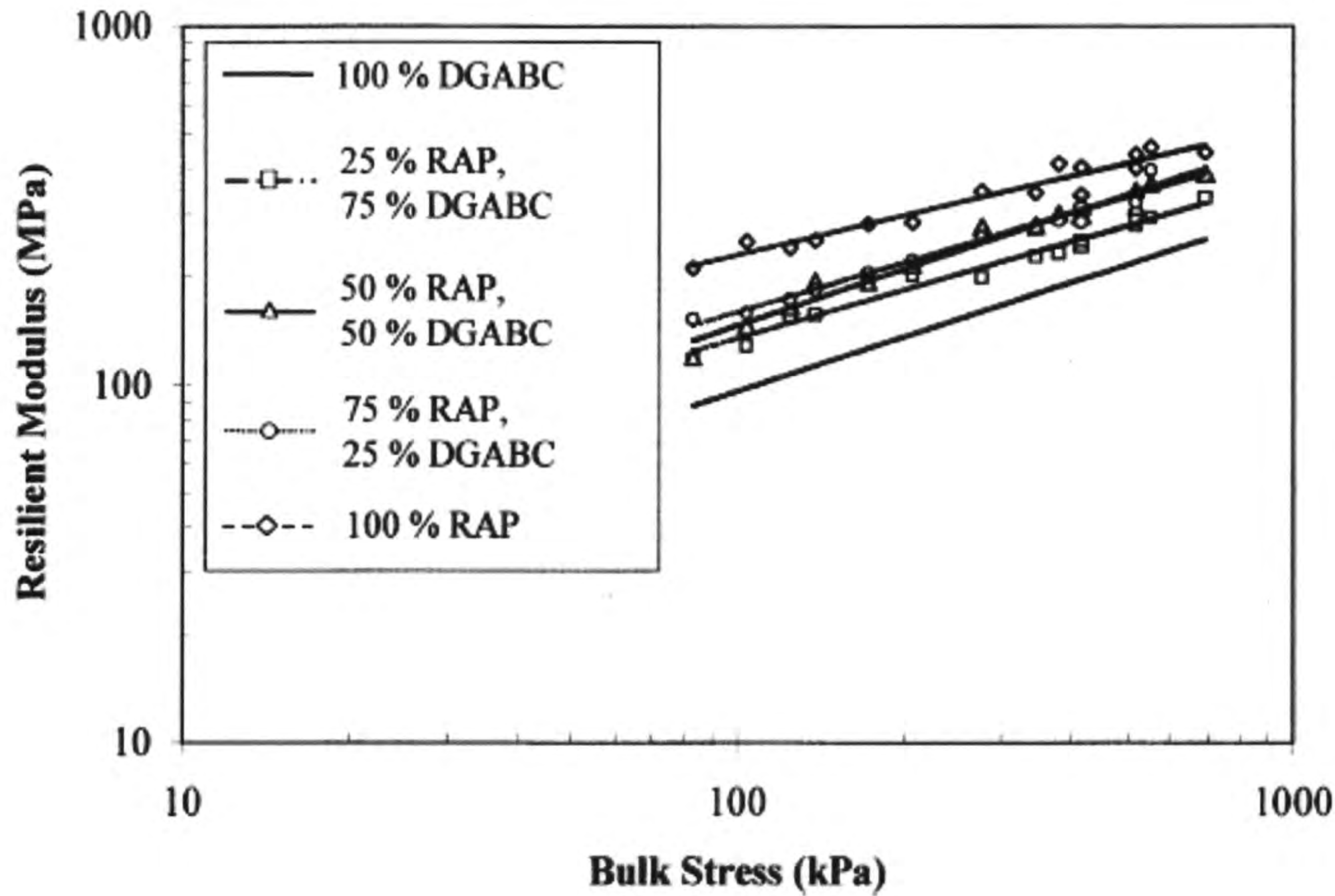

Figure 4.2. Resilient Modulus of Compacted RAP-Blended Specimens (24).

Load Bearing Capacity

The key design parameter for incorporating processed RAP into granular base material is the blending ratio of RAP to conventional aggregate that is needed to provide adequate bearing capacity. The bearing capacity of aggregate-RAP blends is strongly dependent on the proportion of RAP to conventional aggregate as well as the character of the DGABC. The bearing capacity of coarse angular aggregate may be unaffected or may decrease with increasing RAP content, whereas the bearing capacity of finer grained pit-run soil aggregate may increase with added RAP. This finding is based on shear strength (Figure 4.3) and R-Value (Figure 4.4) tests on coarse (CBC #3) and fine-grained (pit run) materials blended with RAP that Mokwa and Peebles (20) conducted.

California Bearing Ratio (CBR) values have been shown to decrease almost directly with increasing RAP contents (18). Hanks and Magni (23) deduced that the CBR is reduced below that expected for conventional granular base when the amount of RAP exceeds 20 to 25 percent.

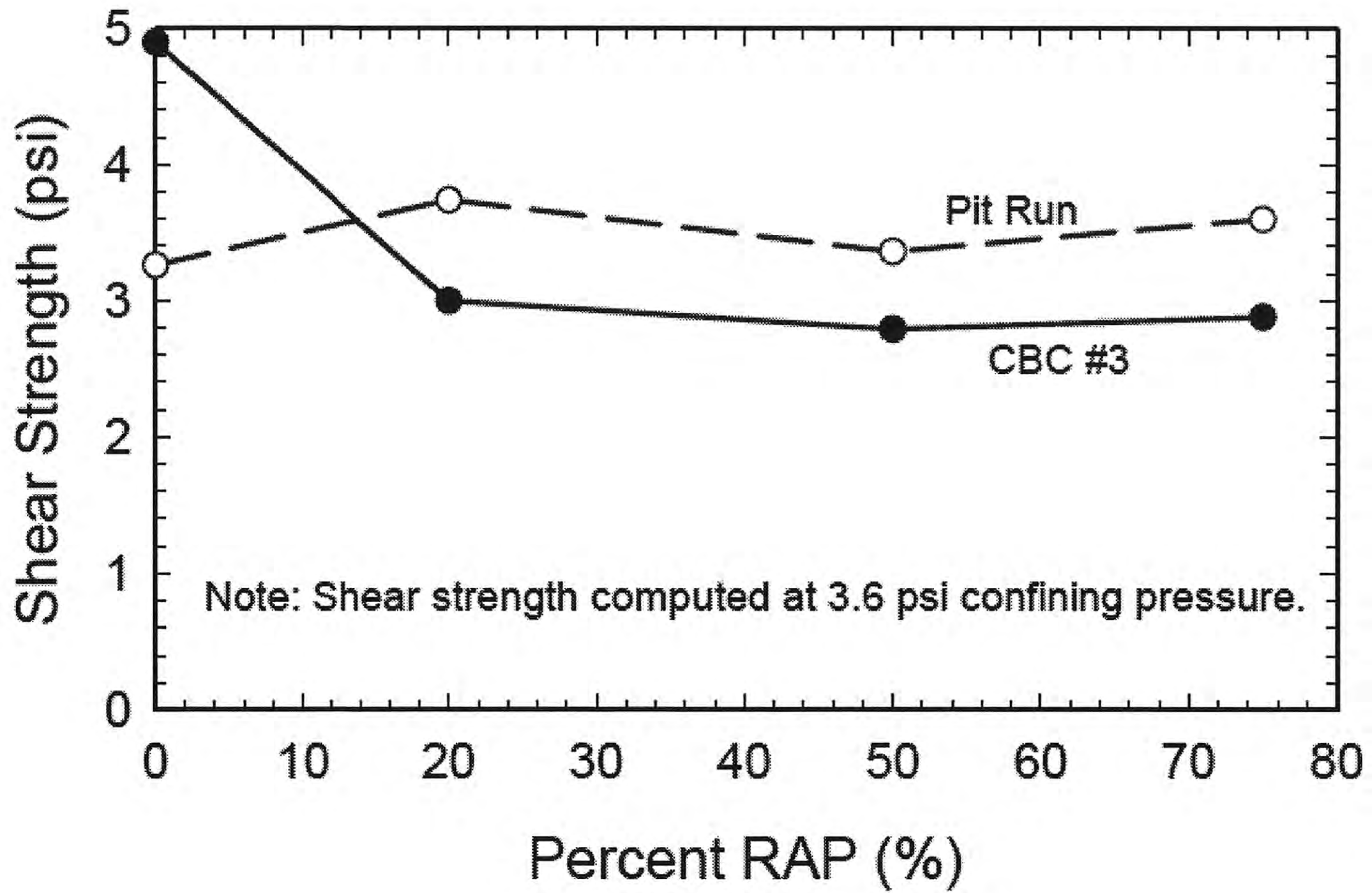

Figure 4.3. Relationship between Shear Strength and RAP Content (after Mokwa and Peebles, 2005).

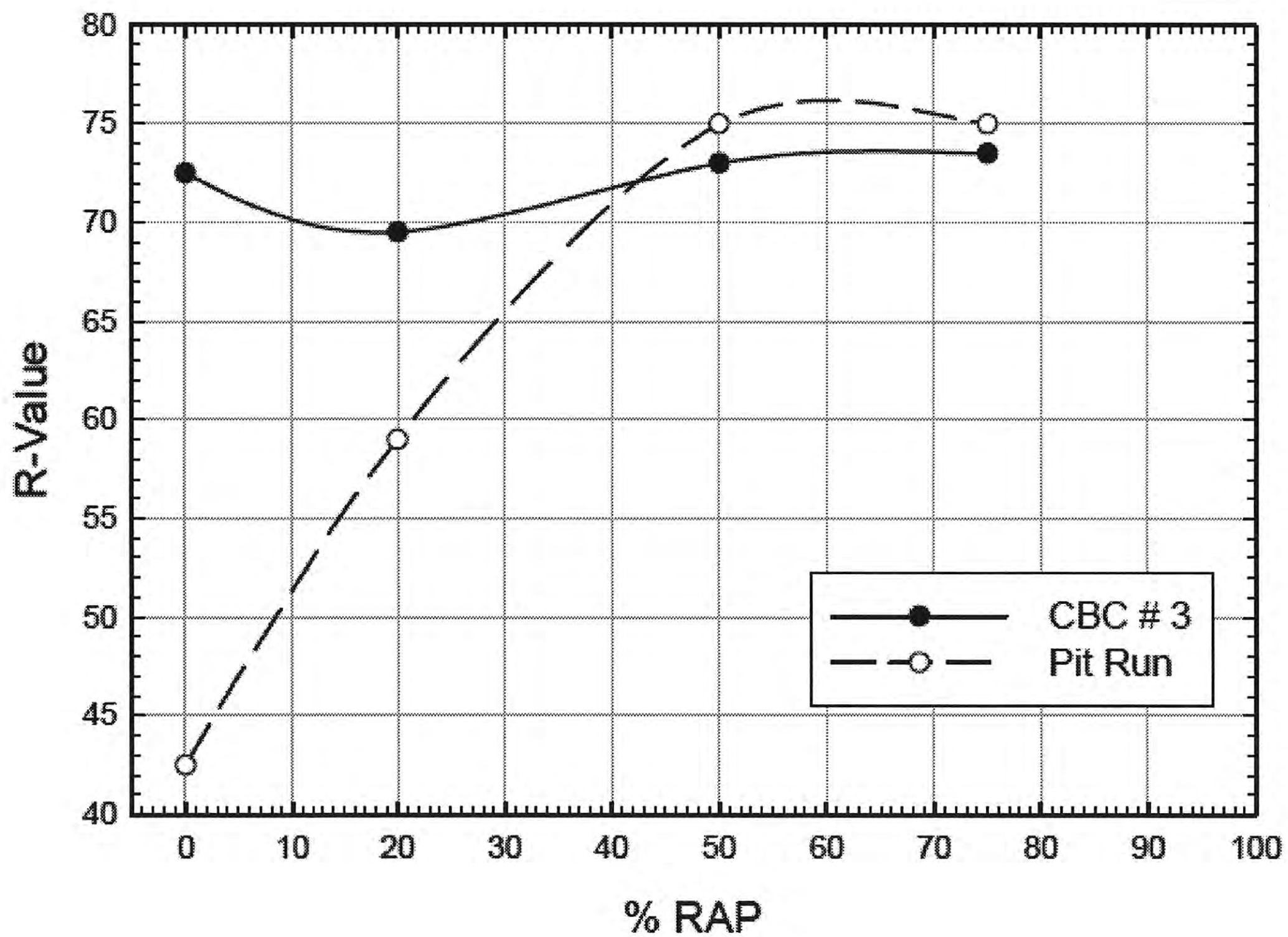

Figure 4.4. Average R-Value as a Function of RAP Content (after Mokwa and Peebles, 2005).

After testing pure RAP and RAP blends with the base material, Bennert and Maher (19) concluded that CBR values decreased as the percentage of RAP increased. They further stated that shear strength and CBR properties of the 100 percent RAP samples were found to be similar to those of standard New Jersey DOT materials, providing evidence that RAP can be included, in limited amounts, in the base course aggregate layer. Asphalt content in RAP does not seem to substantially impact the strength and modulus of cement-treated RAP mixes (16).

Yuan et al. (16) concluded that results from unconfined compressive strength (UCS), indirect tensile strength (ITS), and free-free resonant column (FFRC) modulus tests are quite consistent. Corresponding to a 300-psi UCS, ITS and FFRC moduli were about 40 psi and 1000 ksi, respectively. For the mixes that meet the 300-psi UCS requirement, the average retained UCS, ITS, and FFRC modulus from tube suction tests meet or almost meet the recommended value of 80 percent, and the average retained UCS values from wet-dry testing are similar.

Mokwa and Peebles (20) examined changes that occur in the engineering properties of aggregate materials when mixed with various amounts of RAP. They concluded that blending RAP with crushed aggregate or pit run gravel resulted in only minor changes to the engineering properties of the virgin material. The specific gravity, maximum dry density, shear strength, and stiffness of the blend decreased as the percentage of RAP was increased. R-values for the two virgin aggregates were acceptable with up to 75 percent RAP in the blends. No significant changes were observed in the resistance to degradation.

Permanent Deformation

Bennert and Maher (19) and Bennert et al. (24) concluded that incorporation of RAP yielded larger permanent deformations during cyclic triaxial testing (Figure 4.5). They prepared specimens using five blends from 100 percent base aggregate to 100 percent RAP at 25 percent increments using their respective OMCs as standard Proctor had determined. A constant confining stress of 103 kPa was applied to each sample during testing. The samples were axially loaded with a cyclic deviator stress of 310 kPa for 100,000 cycles. Compacted specimens were tested under drained conditions during static triaxial loading.

Saeed (17) also reported increased permanent deformation when RAP was added to base aggregate. At room temperature, cyclic stress was incrementally increased from 10 to 180 psi

after 1000 axial load cycles at each stress level. A confining pressure of 15 psi was used for all tests. Wet test specimens were allowed to drain for one hour prior to testing. Repeated loads were applied to both wet and dry specimens in stages. Axial loads were applied to specimens using a haversine waveform consistent with AASHTO T 307 using 0.1-second load duration followed by 0.9-second rest period. A contact load equal to 1 psi (approximately 30 lb for a 6-inch diameter cylindrical test specimen) was maintained at all times during testing.

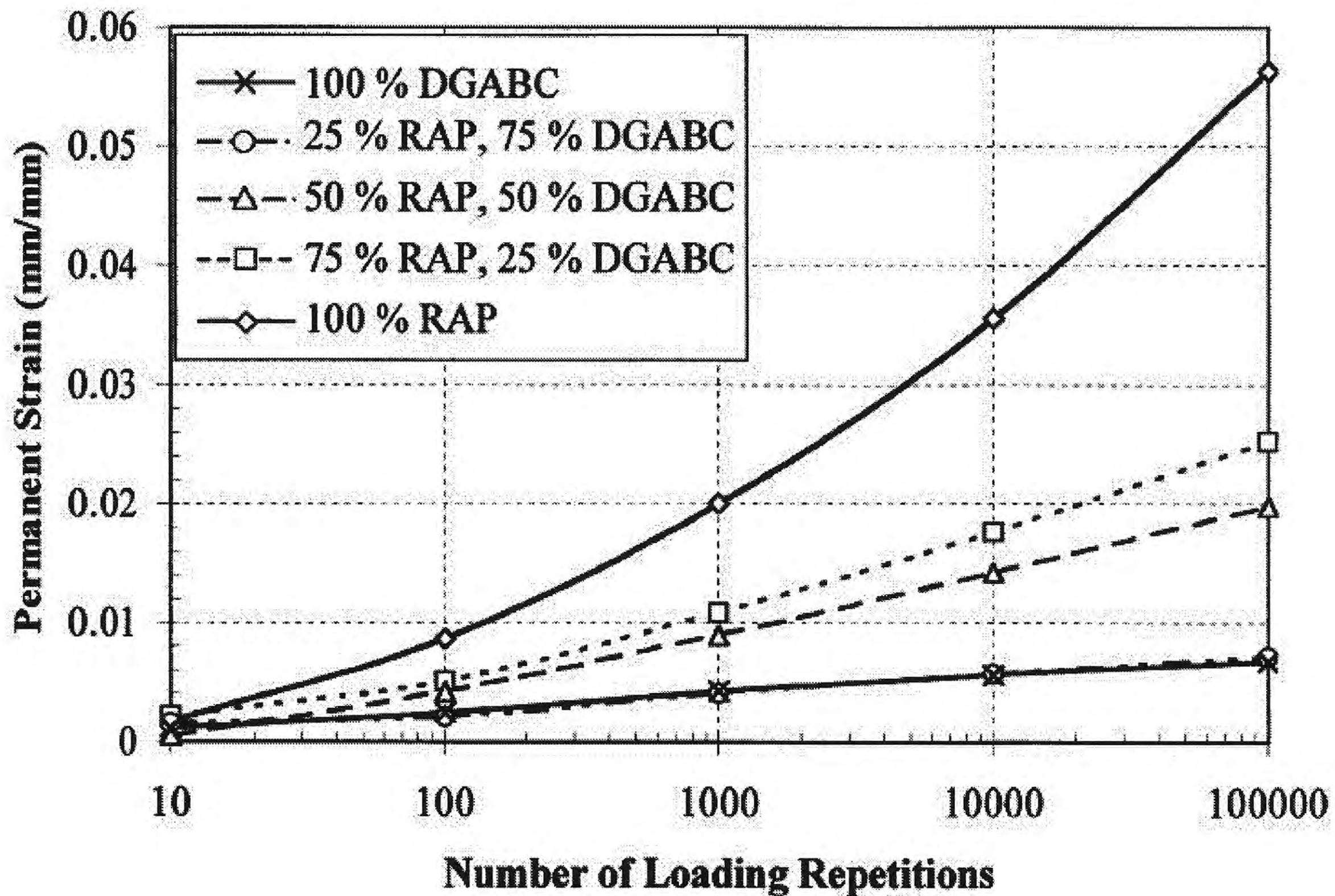

Figure 4.5. Permanent Deformation of Compacted RAP-Blended Specimens (after Bennert et al. 2000).

Permeability

Permeability of blended granular material containing RAP is apparently dependent on the situation (e.g., character of RAP and base aggregate, combination of materials, and method and degree of compaction). Bennert and Maher (19) tested pure RAP and RAP blends with base material and concluded that as the percentage of RAP increased in the blend, permeability decreased; in fact, they further stated that RAP percentages above 50 percent greatly decrease permeability. Mokwa and Peebles (20) reported that permeability increased as the percentage of

RAP increased. Hanks and Magni (23) reported permeability of blended granular material containing RAP is similar to conventional granular base course material.

Curing Conditions

None of the research studies consulted in this discussion of RAP in base mixes mentioned any curing before testing in their laboratory studies; therefore, it is assumed that no curing was performed between specimen preparation and testing. The FHWA (14) stated that the presence of asphalt cement in the RAP provides a significant strengthening effect with time. They referenced Hanks and Magni (23) who reported that specimens containing 40 percent RAP blended in granular base material produced CBR values exceeding 150 after one week. They did not reveal the original CBR values.

Durability

The quality of virgin aggregates used in asphalt concrete usually exceeds the quality requirements for granular base aggregates. For this reason, there are generally no durability concerns regarding the use of RAP in granular base, particularly when the RAP content is less than 25 percent of the base material (14).

Recommended RAP Content

The FHWA (14) guidelines, which use several references, state that blends of up to 30 percent asphalt-coated particles from RAP have been incorporated into successful granular base materials. They indicate that 40 percent RAP blended in granular base material has produced CBR values exceeding 150 after one week, referencing Hanks and Magni (23). RAP produced by grinding or pulverizing has a lower bearing capacity than crushed RAP, due to the generation of more fines (25) and therefore may allow lower acceptable contents. As a result, for use in load-bearing applications, coarser graded RAP is ideally blended with conventional aggregates. If less than 30 percent RAP is used, the structural layer coefficient normally recommended for granular base materials can be used; however, if RAP constitutes greater than 30 percent, some adjustment of the structural layer coefficient may be appropriate.

Bennert and Maher (19) recommended that the percent by total weight allowed for RAP blended with granular base should be limited to 50 percent. They demonstrated that RAP

percentages greater than 50 percent greatly decreased CBR values. Mokwa and Peebles (20) found acceptable R-values for two base aggregates with up to 75 percent RAP.

Saeed (17) conducted tests on RAP and RCA containing three different constituent aggregates (crushed limestone, granite, and gravel) and various blends to provide a range of performance (Table 4.3). The recycled materials were blended with a virgin aggregate that was known to provide good performance when used in unbound pavement layers.

Table 4.3. Selected Materials or Blends with Expected Performance Potential (17).

Proposed Materials		Expected Performance Potential
100 % RCP (granite)		Excellent
Limestone aggregate (virgin - for blending)		
100 % RCP (limestone)	50 % RCP (granite) + 50 % limestone aggregate	Very Good
50 % RCP (limestone) + 50 % limestone aggregate		
100 % RCP (gravel)	50 % RAP (limestone) + 50 % limestone aggregate	Good
100 % RAP (limestone)	50 % RAP (gravel) + 50 % limestone aggregate	
50 % RAP (granite) + 50 % limestone aggregate		Fair
100 % RAP (granite)		
50 % RAP (gravel or soft limestone) + 50 % limestone aggregate		Poor
100 % RAP (gravel or soft limestone)		

RECLAIMED CONCRETE AGGREGATE

FHWA (26) states that RCA is a viable material for use in granular base, either by blending with virgin aggregate or by using 100 percent RCA. Nearly all state DOTs allow the use of RCA in base. There are written specifications for its use in highway construction. They also indicate that unbound cementitious material in RCA will improve the strength in a base layer.

Bennert and Maher (19) compared pure granular base with blends of RCA in granular base and found that RCA provided higher OMC, larger CBR values, larger resilient moduli, and lower permanent deformation values. However, as the RCA content increased, permeability of the blend decreased. They further recommended that RCA can be blended as high as 75 percent with dense graded base. More than 75 percent RCA may create a very “tight” aggregate

structure that will not allow drainage, as shown by permeability tests on 100 percent RCA, which was almost impermeable. Formation of tufa (a calcium precipitate primarily from RCA fines) with time can further reduce permeability.

Figure 4.6 shows that the M_R increased with increasing RCA content (24). All tests were conducted at OMC using the test specifications that AASHTO TP 46-94 designated. Figure 4.7 demonstrates that similar specimens exhibited decreasing permanent strain with increasing RCA content.

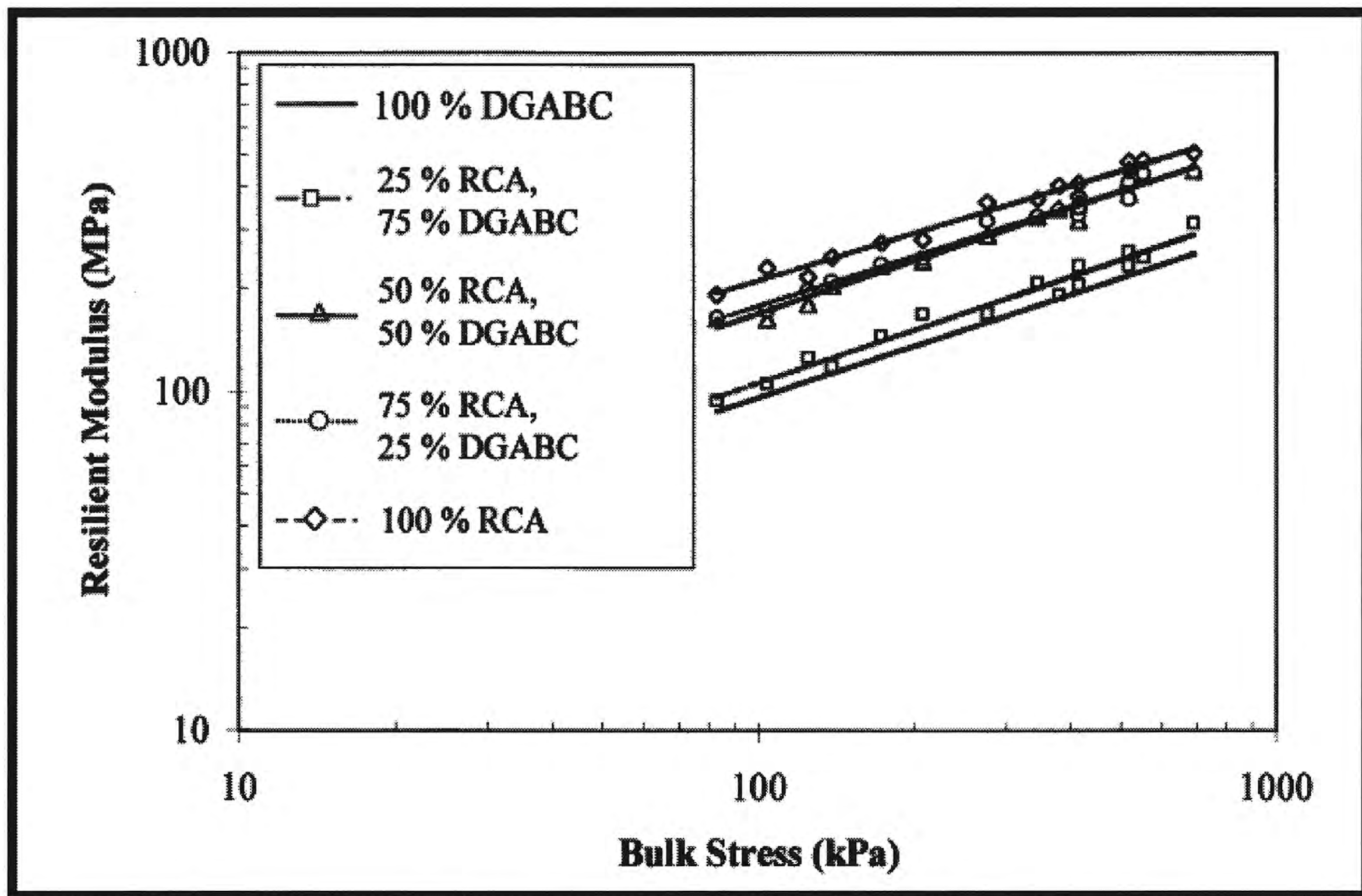

Figure 4.6. Resilient Moduli of Compacted Specimens with RCA (24).

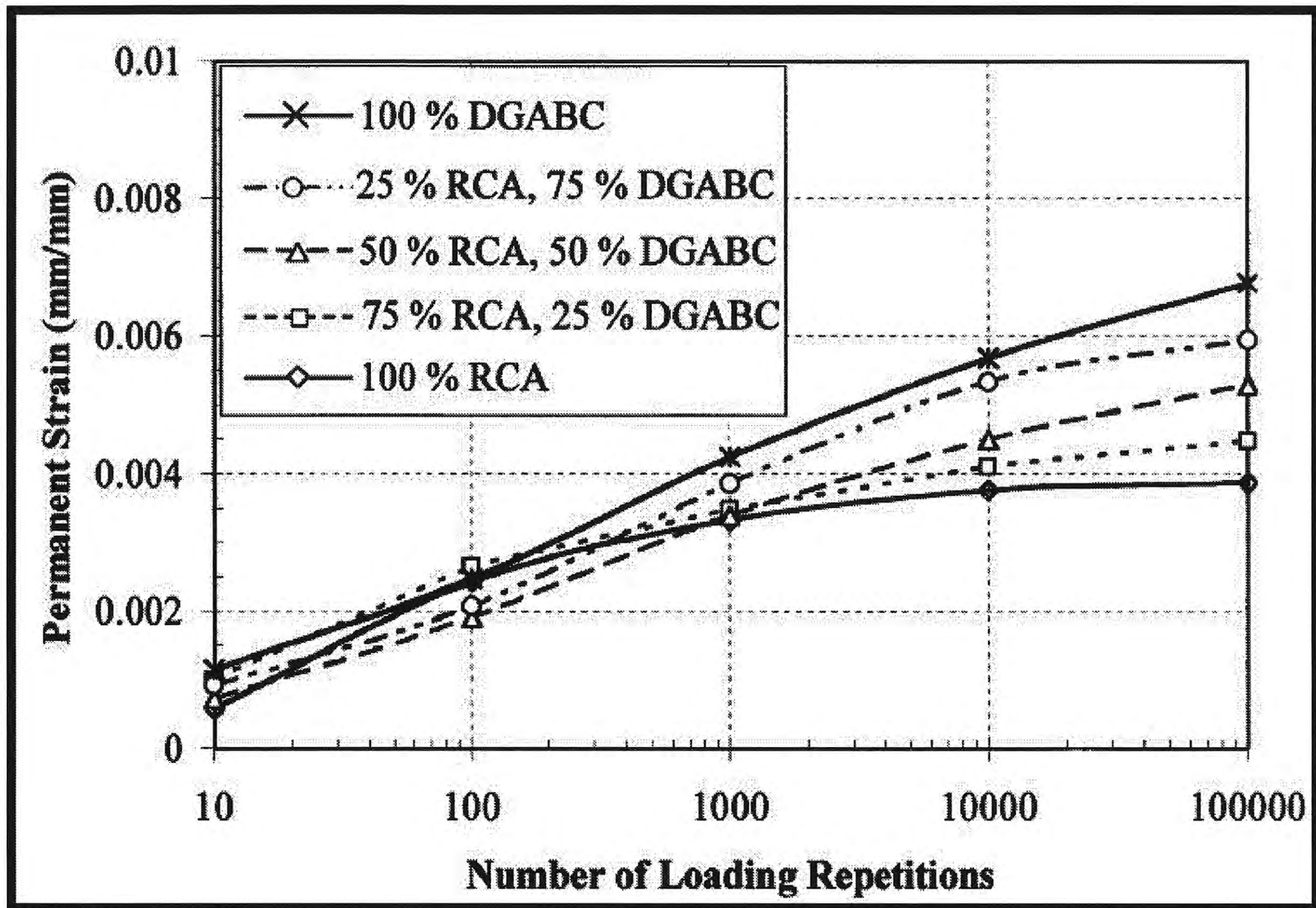

Figure 4.7. Permanent Deformation of Compacted Specimens with RCA (24).

AASHTO M 319 is a standard specification for Reclaimed Concrete Aggregate for Unbound Soil-Aggregate Base Course. It provides guidance on mixture design, materials requirements, testing, and process control when using RCA in aggregate base layers.

According to the FHWA (26), the Virginia DOT and local aggregate suppliers had been using RCA for more than nine years and overcame some barriers. A summary of their experiences is provided below.

- Recommendations for compacting RCA when it is used in base and sub-base are:
 - Compaction of RCA in base should be in a saturated state to aid in the migration of fines throughout the mix.
 - Compaction of RCA should be performed using steel wheel rollers, because of minor amounts of re-bar present in the base that cause problems when using rubber-tired equipment.

- Recommendations for reducing contamination of concrete rubble for processing into aggregate are:
 - Inspection of dump trucks.
 - Limitation of the concrete rubble sources by aggregate producers.
 - Improvement and adaptation of equipment in the processing procedures.
- Establishment of agreements on solid waste management practice, including RCA.
 - Virginia Department of Waste Management and VDOT developed an executive compliance agreement that defines solid waste management practices during construction and repair of highways.

The Minnesota DOT pooled-fund study website, available at <http://www.pooledfund.org/>, maintains that environmental concerns related to RCA have focused on the relatively high pH (greater than 11) of the effluent produced by drainage systems that remove water from untreated recycled concrete aggregate foundation layers. Some RCAs have been shown to contain constituents (arsenic, chromium, aluminum, and vanadium) that are considered hazardous in drinking water. However, a detailed study (27) using atomic absorption concluded that well-cured (28 days) 100-mm cubes of portland cement concrete (Note: uncrushed material) released no detectable concentrations of antimony, arsenic, beryllium, cadmium, chromium, lead, mercury, nickel or selenium. For poorly cured concrete cubes, only vanadium leached in detectable quantities. Leaching tests were conducted in static water at room temperature for up to 256 days.

LABORATORY TESTS ON BASE MATERIALS CONTAINING RECYCLED PAVEMENT MATERIALS

According to Saeed (17), RAP and reclaimed concrete aggregate contain binders and contaminants (associated with construction and demolition) that are not found in virgin aggregates. This difference in material constituents, long exposure of RAP and RCA to the elements, and constructability concerns raise questions about the validity of tests designed for evaluating virgin aggregates when used in evaluating RAP and RCA materials. Therefore, he conducted tests on RAP and RCA containing three different aggregates (i.e., crushed limestone, granite, and gravel) to provide a range of materials with poor to excellent performance. These recycled materials were blended with a virgin aggregate known to provide good performance in

unbound pavement layers. The main goal was to recommend procedures for performance-related testing and selection of RAP and RCA materials for use as aggregates in unbound pavement layers, singularly or in combination with other materials. He concluded that the following tests relate to the performance of recycled materials used in unbound pavement layers:

- Screening tests for sieve analysis and the moisture-density relationship.
- Micro-Deval test for toughness.
- Resilient modulus for stiffness.
- Shear strength using static triaxial and repeated loading at optimum moisture content and saturated.
- Tube suction test for frost susceptibility.

Kim and Labuz (28) indicated that compaction by dropping a mass had been questioned as an appropriate procedure for simulating field compaction of granular materials. Therefore, they used 50 gyrations of a Superpave gyratory compaction (SGC) along with standard Proctor compaction (PC) to prepare DGABC + RAP specimens. Although the report does not say, the field mixture appeared to be approximately a 50-50 blend. Comparisons with field density measurements indicated that the MDD and OMC calculations determined from SGC methods gave better correlations to the field (sand cone) than those determined by PC (Figure 4.8). When compared to PC results, SGC results showed a large change in MDD values and a small change in OMC values. Additionally, they showed that as the RAP content increased, the OMC decreased for both the SGC and PC prepared specimens. As in Guthrie's study (22), the increase in asphalt content when adding RAP most likely reduced the absorptivity of the bulk material, leading to the decrease in OMC. As the RAP content of their materials increased, the MDD decreased for the PC specimens but remained about the same for SGC specimens (28).

Saeed (17) cataloged test methods that have a high composite rating for evaluating factors that influence the performance of recycled aggregate and differentiate between good and poor pavement performance potential (Table 4.4). He asserted that most state DOTs can perform these test methods at a reasonable cost.

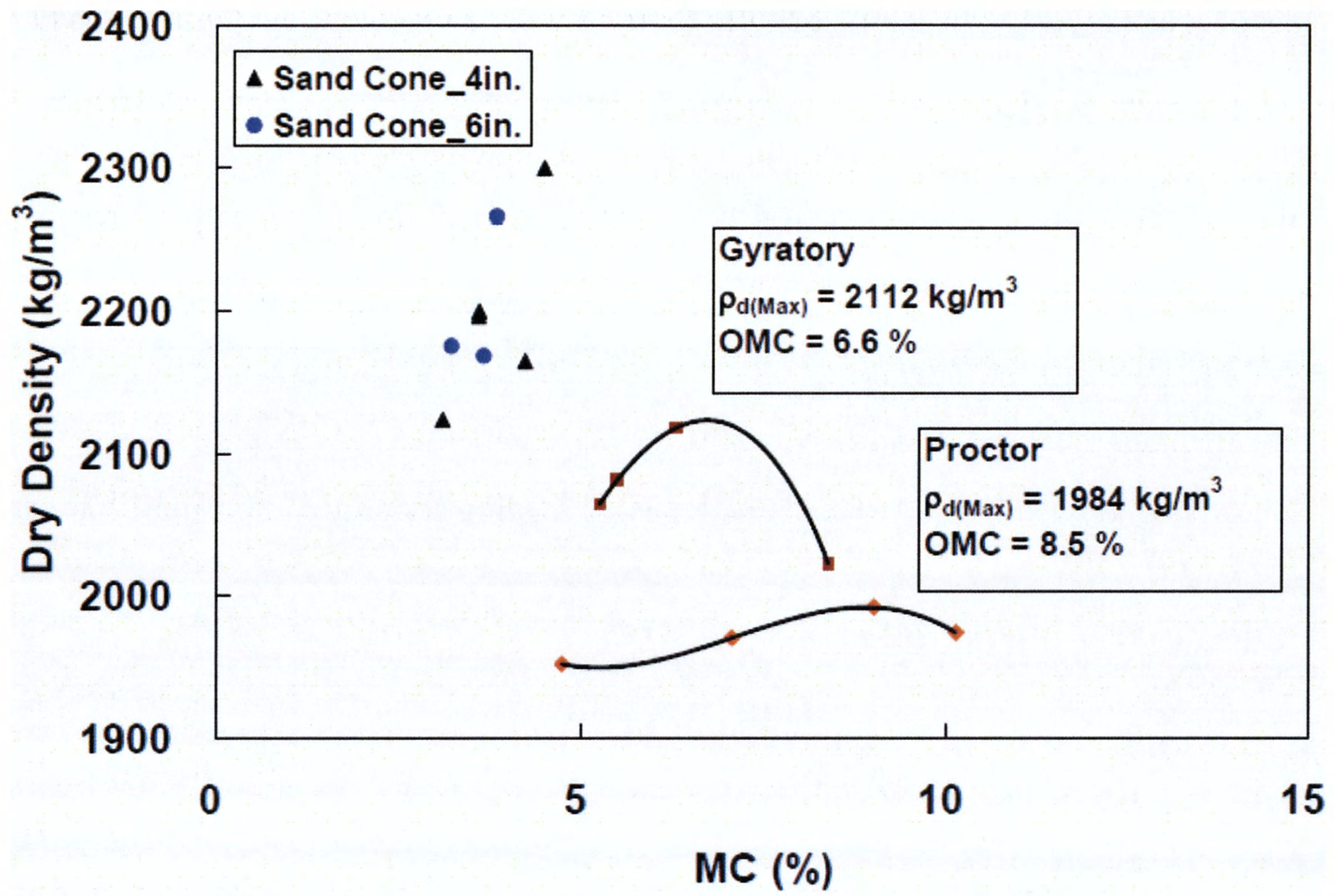

Figure 4.8. Compaction Method Comparison Using Field Blend (approximately 75% DGABC + 25% RAP) (28).

Table 4.4. Rating of Potential Test Methods for Evaluating Recycled Aggregates (17).

Property measured	Test	Performance predictability	Accuracy	Practicality	Complexity	Precision	Cost	Composite
Shear Strength	Static Triaxial Shear	F	G	H	FS	G	M	H
	Repeated Load Triaxial	G	G	H	C	G	M	H
	Texas Triaxial	F	G	M	FS	F	M	M
	Illinois Rapid Shear	F - G	G	M	FS	G	M	M - H
	Confined Compression	F	F	M	S	F	L	M
	Direct Shear	F	F	L	FS	F	M	M
	Gyratory Shear	F	F	M	C	F	M	M
	k-Mould	G	G	M	C	F	M	M
	CBR	F	F	M	S	F	L	M
	Hveem Stabilometer	F	F	M	S	F	L	M
	Hollow Cylinder	G	G	L	VC	L	H	L
	Dynamic Cone Penetrometer	F	F	M	S	F	L	M
	Lab Rut-Tester	G	F	L	C	F	H	M
Stiffness	Resilient Modulus	G	G	H	C	G	M	H
	Var. Conf. Pres. Modulus	F	F	L	VC	F	H	L
	Resonant Column	P	P	L	C	P	M	L
Frost Susceptibility	Frost Susceptibility Test	F	F	L	C	P	H	L
	Tube Suction Test	G	G	M	FS	G	M	H
	Index Tests	F	G	H	S	F	L	H
Permeability	Constant Head	F	F	M	FS	F	L	M
	Falling Head	F	F	H	FS	F	L	M
	Pressure Chamber	F	F	H	FS	F	M	M
	Horizontal Permeameter	F	F	H	FS	G	M	M
Toughness	LA Abrasion	F	F	M	S	F	L	M
	Aggregate Impact Value	F	F	F	S	F	L	M
	Aggregate Crushing Value	F	F	F	S	F	L	M
	Aggregate Abrasion Value	P	P	P	FS	P	L	L
	Micro-Deval	G	F	M	S	F	L	H
	Durability Mill	P	P	P	FS	P	L	L
	Gyratory Test	P	P	P	FS	F	M	L
Durability	Tube Suction Test	G	G	M	FS	G	M	H
	Sulfate Soundness	P	P	P	F	F	L	L
	Freezing and Thawing	P	P	P	FS	F	M	L
	Canadian Freeze-Thaw	G	G	M	FS	F	L	H
	Aggregate Durability Index	F	F	H	FS	F	L	M
	Unconfined Freeze Thaw	F	F	H	FS	F	M	M
Particle Geometric Properties	Shape/ Surface Texture Index	F	F	M	S	F	L	M
	Flat and Elongated Particles	P	P	L	C	P	L	L
	Percent Fractured Particles	P	P	L	C	P	L	L
	Uncompacted Void Content	P	P	L	C	P	L	L
	Digital Image Analysis	P	P	L	C	F	H	L
	Atterberg Limits	F	F	M	S	F	L	M

Rating Scale:

- Performance Predictability - G = good, F = fair, P = poor
- Accuracy - G = good, F = fair, P = poor
- Practicality - H = high, M = medium, L = low, F = fair, P = poor
- Complexity Levels - S = simple, FS = fairly simple, C = complex, VC = very complex
- Precision - G = good, F = fair, P = poor, L = low
- Cost - H = high, M = medium, L = low
- Composite - H = high, M = medium, L = low (based on relative ratings of other factors)

- Notes:**
1. All ratings are average subjective evaluations of research team.
 2. The composite rating is based on the relative ratings for each category.

BUILDING DERIVED AGGREGATE

Recent research (29) performed at the Recycled Materials Research Center of the University of New Hampshire indicates that building derived aggregate (BDA) is a usable substitute for crushed stone. BDA is a mixture of concrete, stone, brick, soil, and non-organic materials derived primarily from the demolition of industrial buildings. The study is based on compaction of 100 percent BDA and 100 percent crushed stone, both at optimum moisture content, in 4-ft square pits 28 inches deep. They used portable compactors to achieve the desired density. Generally, their findings were somewhat similar to those often reported for crushed concrete.

Martin et al. (29) found that micro-deval abrasion losses for the BDA were slightly above the allowable limit that ASTM established. Stiffness increase of the compacted layer (as the lightweight falling deflectometer had measured) was almost 50 percent more than that of the crushed rock and did not decrease with time like the crushed rock. They concluded that the presence of so-called deleterious materials, such as brick and tile, is not significant and that BDA can be used as base course aggregate. Based on their findings, it appears that BDA blended with virgin DGABC might provide satisfactory and cost-effective alternatives as base layers.

POTENTIAL FINDINGS FROM ONGOING ROAD TESTS

The Minnesota DOT is beginning the fifth and final year of a pooled-fund study to monitor the performance of several test cells at the Minnesota Road Research Facility (MnROAD) that were constructed using recycled materials in the granular base layers, including some blended with virgin materials and 100 percent RAP and RCA materials. Material properties were monitored during construction and throughout the pavement life in order to determine their effects on pavement performance. These properties will be used to verify mechanistic-empirical design inputs, particularly their variation with changing seasons and moisture regimes. The Transportation Pooled-Fund website, available at <http://www.pooledfund.org/> contains quarterly reports but no significant findings at this time. Findings should be available after mid-2012, well before the termination date of TxDOT Project 0-6621.

CONCLUSIONS

Based on the findings in this brief summary of pertinent literature, it appears clear that RAP and/or RCA are viable materials for blending with granular base material and capable of providing adequate performance. However, because of significant differences in various virgin aggregates as well as RAP and RCA, testing should be performed to verify that the blended materials meet the general specifications as well as the specific requirements for the project.

Most researchers found that, as one might expect, an increase in RAP content in DGABC typically yields a decrease in maximum dry density and optimum moisture content values. RAP will increase stiffness of granular base but likely will also increase permanent deformation potential. Increasing RAP content will typically decrease CBR values of DGABC.

It appears that about 30 percent RAP can be satisfactorily used in granular base. Some have successfully used up to 75 percent RAP in base layers. Bearing capacity (as measured by R-Value) of coarse angular aggregate may be unaffected or may decrease with increasing RAP content; however, bearing capacity of finer grained pit-run soil aggregate will likely increase with added RAP. So an acceptable maximum quantity of RAP will, of course, depend on the engineering properties of the DGABC and the RAP.

Since Texas RAP is generally low in No. 40 material, RAP mixed with DGABC having higher fines content can improve the quality of the blend. However, particle size distribution of coarse aggregate has only minor impacts on strength and modulus of cement-treated RAP mixes.

When RCA is blended with granular base, higher OMC, larger resilient moduli, lower permanent deformation values, and larger CBR values may be expected. Further, unbound cementitious material in RCA will provide additional stiffening/strengthening with time. However, as the RCA content increases, permeability of the blend may decrease. RCA has been successfully blended as high as 75 percent with dense graded base. More than 75 percent RCA may create a very “tight” aggregate structure that will not allow drainage. Compaction of RCA in base should be in a saturated state to aid in the migration of fines throughout the mix. BDA blended with DGABC appears promising for use as base material.

CHAPTER 5. SMOOTHNESS ACCEPTANCE CRITERIA FOR FLEXIBLE BASE

OVERVIEW

Pavement ride quality is one of the chief interests of the travelling public and, consequently, of interest to TxDOT. The measurement of International Roughness Index (IRI) is measured using inertial road profilers. Longitudinal road profile consists of long wavelengths including hills and undulations, short wavelengths that are due to bumps and dips, and very short wavelengths caused by the macro-texture of the paved surface. Transverse road profile includes the latter two of these plus rutting in the wheel paths.

TxDOT Item 247 contains specifications for materials and construction of flexible base but does not contain any criteria for smoothness of the finished surface. TxDOT Item 585 provides specifications for ride quality of pavement surfaces and includes a pay adjustment schedule. However, Item 585 addresses only finished paved surfaces. The final surface on some pavements is a one- or two-course surface treatment.

TxDOT recognized the importance of the smoothness of the base surface in obtaining smoothness of the final surface, particularly when the final surface is a surface treatment. Therefore, in TxDOT Project 0-4760, Fernando et al. (30) developed specifications and guidelines for obtaining acceptable IRIs for the surfaces of compacted and finished flexible base layers. They recommended the following special provision to Item 247 for ride quality of flexible bases along with data for its justification.

SPECIAL PROVISION

247—011

Flexible Base

For this project, Item 247, “Flexible Base,” of the Standard Specifications, is hereby amended with respect to the clauses cited below, and no other clauses or requirements of this Item are waived or changed hereby.

Article 247.4. Construction is supplemented by the following:

F. Ride Quality. This section applies to the final travel lanes that receive a 1 or 2 course surface treatment for the final surface, unless otherwise shown on the plans.

Measure ride quality of the base course after placement of the prime coat and before placement of the surface treatment. Use a high speed or lightweight inertial

profiler certified at the Texas Transportation Institute. Provide the Engineer with equipment certification documentation. Display a current decal on the equipment indicating the certification expiration date. Use a certified profiler operator from the Construction Division's approved list. When requested, furnish the Engineer documentation for the person certified to operate the profiler.

Within 3 days after placement of the prime coat, provide all profile measurements to the Engineer in electronic data files using the format specified in Tex-1001-S. The Engineer will use Department software to evaluate longitudinal profiles to determine areas requiring corrective action. Correct 0.1-mi. sections having an average IRI value greater than 125.0 in. per mile to an IRI value of 125.0 in. per mile or less for each wheel path, unless otherwise shown on the plans.

Re-profile and correct sections that fail to maintain ride quality after placement of the prime coat, as directed by the Engineer. Correct re-profiled sections until specification requirements are met. Perform this work at no additional expense to the Department.

According to Fernando et al. (30), the general consensus, particularly among contractors, is that it is more difficult and expensive to correct IRI-deficient sections after placement of the surface treatment. Thus, the specification stipulates quality assurance IRI tests on the flexible base after placement of the prime coat but before placement of the surface treatment. Although Item 585 for paved surfaces includes pay adjustment factors, the special provision for finished bases does not.

Some TxDOT districts have accepted and are using Special Provision 247-011 on selected projects, particularly on those where the final pavement is a surface treatment. The Odessa District accepted the Special Provision and stipulated that the acceptable IRI is 100 instead of 125. The Odessa District has historical data demonstrating that contractors routinely achieve a base IRI of 100 or better.

One reason to measure IRI of the finished base instead of the final surface treatment is because the surface treatment will likely exhibit a higher IRI than the corresponding base surface (Figure 5.1). This is because the much higher texture of the surface treatment increases the IRI measurement.

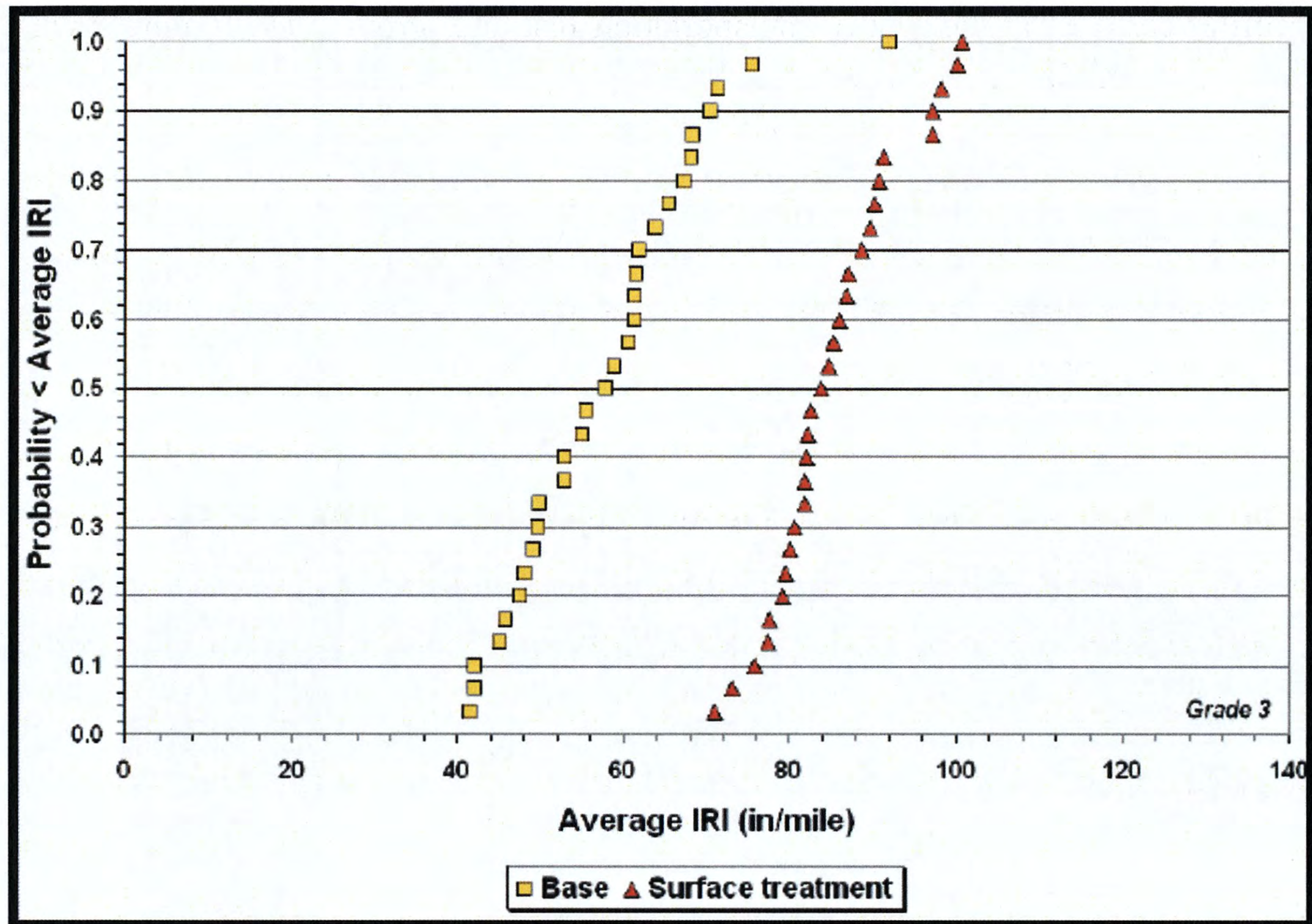

Figure 5.1. Distributions of Average IRIs on Flexible Base and First Course Surface Treatment on FM 2401 Project in the Odessa District (30).

ISSUES THAT AFFECT BASE SMOOTHNESS

Key issues that Fernando et al. (30) emphasized during Project 0-4760 are summarized below.

- Quality assurance tests are typically performed on the finished and primed base.
- Transverse profile is measured using a straightedge. Corrections are made where grade deviations exceed 0.25 in. in 16 ft (measured longitudinally) or where grade deviations exceed 0.25 inch over the entire cross-section width.
- On 0.1-mile sections where the average IRI is greater than 125 in./mile, the contractor must correct to 125 in./mile or less for each wheel path.

Fernando et al. (30) examined IRIs of granular bases in at least five Districts (Atlanta, Brownwood, Odessa, San Angelo, and Yoakum) and concluded that contractors in west Texas

districts can normally construct smoother base layers than those in east Texas Districts (Figure 5.2).

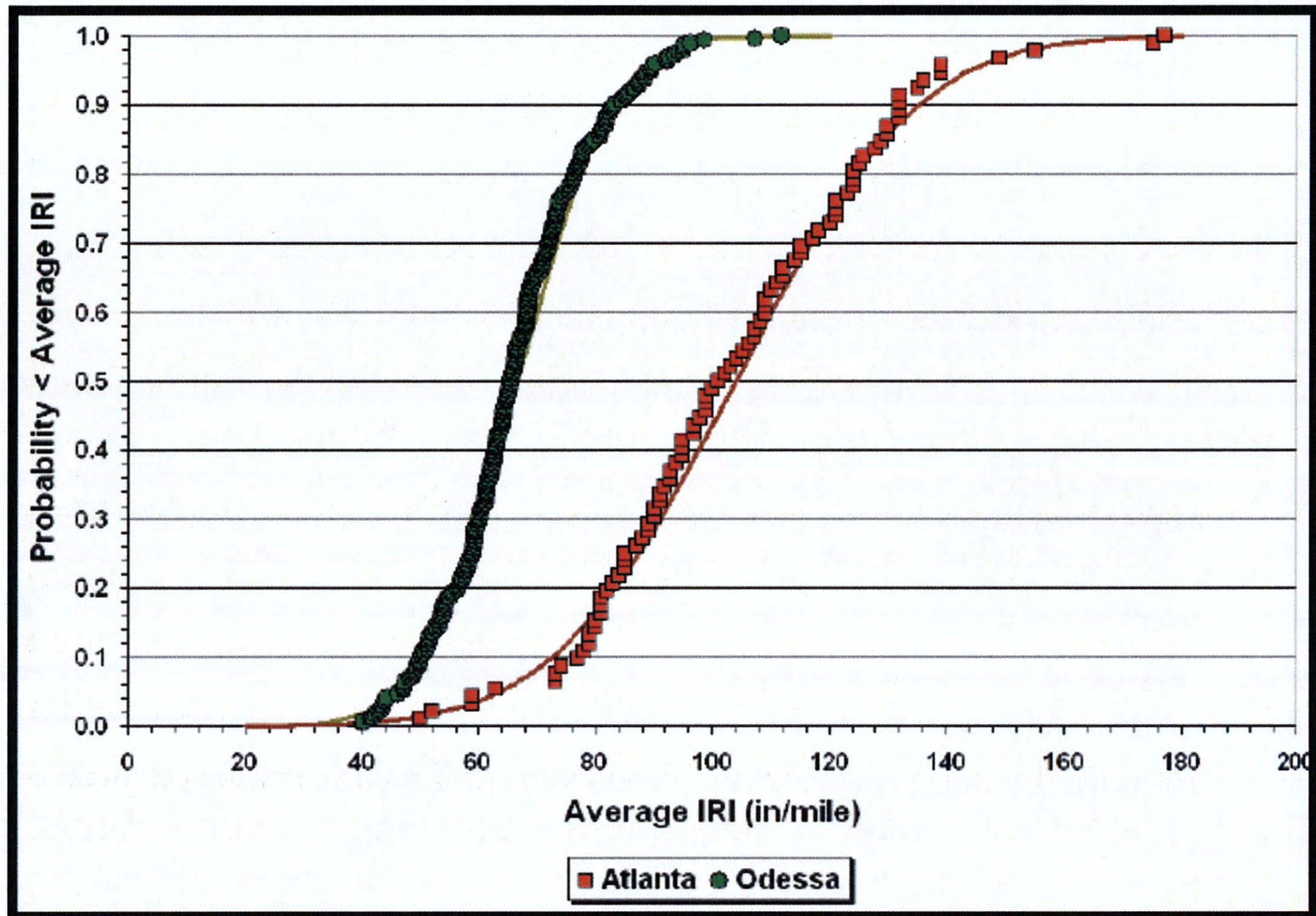

Figure 5.2. Cumulative Distributions of Average Flexible Base IRIs – Atlanta and Odessa Projects (30).

Fernando et al. (30) summarized key items that affect ride quality of a compacted base:

- Terrain – More vertical and horizontal curves, as in east Texas, are detrimental to ride quality when compared to flat terrain with a straight alignment of west Texas.
- Climate – Higher rainfall in east Texas creates more problems in placing base and inhibits smoothness, particularly when the finished base is trafficked for an extended period prior to paving.
- Base Material Type – Limestone, which is typically specified in west Texas is easier to finish when compared to granite and sandstone, which is often used in east Texas.
- Construction Traffic – Vehicular traffic is usually allowed on surface treatment projects. Traffic volume is typically higher in east Texas than in west Texas.

- **Control Points** – Contractors normally set control points to establish slopes and grades. An inadequate number or lack of control points can lead to inferior ride quality due to poor control of the finishing operations on the flexible base, resulting in improper or variable cross-slopes and surface defects.
- **Motor Grader Operator** – Ride quality is totally dependent upon the workmanship (skill and experience of the operator) during finishing of a flexible base, particularly on surface treatment projects.

MEASURES TO ENHANCE BASE RIDE QUALITY

Base Materials

Coarser graded base materials with angular particles are desirable for high strength and stability, but they normally produce rougher surfaces, and vice versa. According to Yuan et al. (16), RAP can increase the coarseness of granular base; and it would appear that RCA can often improve angularity. These could negatively affect the IRI of the base. When a surface treatment is placed on a base course as the final riding surface, creating a smooth surface on the base is critical to the ultimate ride quality.

Placement of Base Materials

Base materials should be spread and shaped into a uniform layer with an approved spreader. Some new types of equipment and/or methods are now available for spreading and shaping base materials that can help the contractor achieve better ride quality. A base laydown machine is a relatively new piece of equipment in the pavement construction market. The base materials are usually mixed in a pug mill and trucked to the project site. Experience with a limited number of projects has shown that this technique provides a better finish of the base and better control of moisture content. Base layers up to 7 inches can be placed in one pass at speeds up to 20 feet per minute (0.23 mph).

Finishing Base Courses

One way to better achieve the desired ride quality on a finished base layer is through the use of automated grade control systems. On the motor grader, the system consists of a computer and display unit, a prism atop a mast, and a radio receiver. Additional system elements include

controls that link the system to the grader's hydraulic blade controls, a robotic total station, and a radio transmitter connected to the robotic total station. The radio transmitter uses a data cable to receive grader blade coordinates from the robotic total station. The computer issues instructions that control the blade through the grader's hydraulic controls. This type of system costs about \$100,000. The equipment can be used to control the grade to within 0.01 ft. Benefits that the contractor can realize include:

- Accurate control of subgrade elevations (no low spots) is achieved, resulting in less waste of base materials.
- A motor grader operator with less experience can achieve the desired smoothness.
- Grading requires less time, since setting stakes and stringlines is unnecessary.

Prior to application of a prime coat, the base should be prepared, compacted, and bladed to grade. Slush rolling is sometimes used to create a smooth surface on the base course. This practice varies among contractors and Districts in the amount of water that is used. If too much water is used, excess fines may be floated to the surface of the base and may result in delamination of the surface treatment.

The Atlanta District inspectors report that implementation of a ride specification on the finished base has given them a tool with which to require contractors to provide a better end product. They report that, when a conventional motor grader is used, the ride quality of the finished base is directly related to the experience of the motor grader operator. Blue top or grade stakes are typically located every 50 ft. Inexperienced operators will tend to be at the correct grade on the stakes and too low in between. Inspectors should watch for this condition, because the only way to correct the low points in the finished surface is to rework the base in these areas. Inspectors should look for missing grade stakes and ensure that the operator did not plow up the stakes by striking off the high points as a means of smoothing out low points between the stakes.

Finally, the surface is prepared for a prime coat. The surface of the fully compacted base should be broomed and/or blown using compressed air until all loose or caked fines and foreign materials have been removed and some stone particles are exposed. A light sprinkling of water may be used in case of a dry surface that has dust (very small quantity) on the surface.

Priming the Base

One of four different types of prime coats is typically applied:

- Spray prime (spray cutback [e.g., MC-30] onto finished base; this is most typical).
- Worked-in prime (mix diluted emulsified asphalt into a thin, last lift of base material and compacted).
- Mixed-in prime (scarify top 2 to 3 in. of compacted base, mix with diluted emulsified asphalt, and re-compact).
- Covered prime (apply RC-250 to the finished base then cover with Grade 5 aggregate).

Covered primes, often placed as a temporary wearing course for traffic, are similar to surface treatments. The surface texture of covered prime can increase the IRI above that of the unprimed base (similar to Figure 5.2). For such cases, Fernando et al. (30) presented detailed field guidelines that the Engineer can use to check the results from IRI quality assurance tests.

RECOMMENDATIONS

Based on the preceding, the authors recommend that TxDOT Districts adopt Special Provision 247-011 to ensure appropriate smoothness of finished and primed flexible bases. This special provision will have particular value when the final pavement will be a one- or two-course surface treatment applied directly to the base.

CHAPTER 6.

POTENTIAL APPROACHES FOR ESTABLISHING PERFORMANCE-BASED PAY FACTORS

OVERVIEW

The development of rational Pay Factors for flexible base courses has received very little attention from the research community. While several approaches have been proposed, most of these approaches are in the research or development stage. Minnesota is currently using a deflection-based system that offers some promise. In addition, considerable information is available on predicting stiffness or resilient modulus values of flexible base course materials from relatively easily determined materials properties.

Pay factor determination is one of the most difficult parts of this research project. The current Draft 2.0 of the QC/QA specification uses a pay factor approach associated with the percent within limits approach as AASHTO recommended. A second possible approach utilizes determination of the stiffness or resilient modulus of the base; based on this value, the performance can be predicted from any number of pavement thickness design approaches. A third approach utilizes performance curves for Texas pavements to describe “as designed” performance of the base course and uses in-place, field property measurements to determine the predicted performance of the “as constructed” base course. This section summarizes an approach to link lab tests to mechanistic models for such an approach. Appendices A and B in this report detail the tests needed, and technical details, associated with developing this approach.

LABORATORY TEST PLAN

Figure 6.1 shows a laboratory test plan employing standard test procedures and methods from TxDOT, ASTM, and AASHTO, with the goal of linking lab tests to mechanistic models. The laboratory tests in Figure 6.1 (further detailed in Appendix A) provide data for five different models that could potentially be used to represent the materials’ performance which include the:

- Soil water characteristic curve (SWCC).
- Unsaturated permeability versus suction model.
- Saturated permeability model.
- Mixture modulus model.
- Permanent deformation model.

Table 6.1 shows the properties needed as inputs to these models. Once inputs are obtained, pavement performance can be predicted with approaches such as used in the MEPDG or VESYS. The repeated load triaxial test in the laboratory generates the measured material performance in order to fit the model parameters to the measured performance.

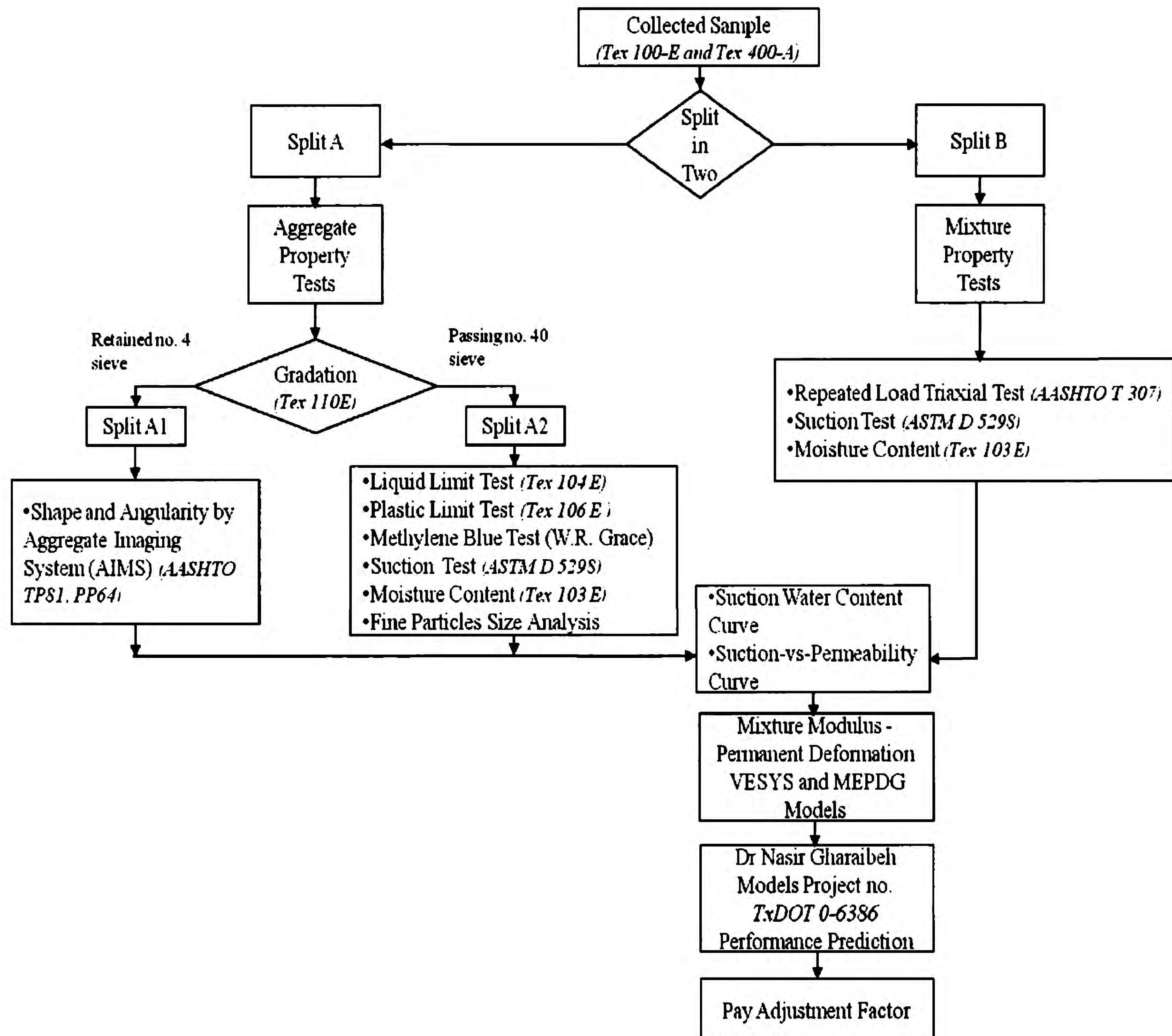

Figure 6.1. Potential Test Plan to Link Lab Tests to Performance for Flexible Base.

Table 6.1. A List of Base Course Properties Obtained by the Laboratory Tests.

Symbol	Property	Test	Test Procedure
D_{60}	The diameter corresponding to 60% finer in the particle-size distribution (from base course gradation curve)	Particle Sieve Analysis	Tex 110-E
P_{200}	Percent passing No. 200 sieve (from base course gradation curve)	Particle Sieve Analysis	Tex 110-E
S_{Grad}	Weibull shape parameter for gradation curve	AIMS	AASHTO TP81, PP64
S_{Shape}	Weibull shape parameter for aggregate shape distribution curve	AIMS	AASHTO T P81, PP64
$S_{Angularity}$	Weibull shape parameter for aggregate angularity distribution curve	AIMS	AASHTO T P81, PP64
LL	Liquid Limit (on passing No. 40 sieve material)	Atterberg Limit	Tex 104 E
PL	Plastic Limit (on passing No. 40 sieve material)	Atterberg Limit	Tex 106 E
PI	Plastic Index (on passing No. 40 sieve material)	Atterberg Limit	Tex 106 E
$- 2 \mu m$	Methylene Blue Value (on passing No. 40 sieve material)	Methylene Blue Test (WR Grace)	
h_m	Matrix suction of as compacted base course material (unit in PF) in laboratory	Filter Paper Test	ASTM D 5298
h_m	Matrix suction of as compacted base course material (in PF) in field	Mid Plane Suction Probe (from GDS)	
ϵ_r	Resilient strain	Repeated Load Triaxial Test	AASHTO T 307-99
γ_d	Dry unit weight	Dry unit weight	Tex 113,114-E
w	Gravimetric water content	Water content	Tex 103-E
G_s	Specific gravity of aggregate	Specific Gravity Test	ASTM C778
β, ϵ_0 and ρ	Material parameters in MEPDG Model	Repeated Load Triaxial Test	AASHTO T 307-99
μ	Constant of proportionality between resilient strain and permanent strain at Nth load repetition in VESYS Model	Repeated Load Triaxial Test	AASHTO T 307-99
α	Permanent deformation parameter indicating the rate of decrease in VESYS Model	Repeated Load Triaxial Test	AASHTO T 307-99

REPEATED LOAD TRIAXIAL TEST

Repeated load triaxial test curves provide the change of strain with time in the laboratory and provide information to predict the permanent deformation properties of a material under traffic loading. Figure 6.2 presents a general repeated load triaxial test stress-time plot. Tseng and Lytton (1989) proposed a model for the prediction of permanent deformation in unbound materials. This model was adopted in the Mechanistic Empirical Design Guide (MEPDG)

$$\delta_a(N) = \beta_1 \varepsilon_v h \left(\frac{\varepsilon_0}{\varepsilon_r} \right) e^{-\left(\frac{\rho}{N}\right)^\beta} \quad (1)$$

where:

$\delta_a(N)$ = Permanent deformation for granular layer (in.).

N= Number of load applications.

β , ε_0 and ρ = Material parameters.

ε_v = Average vertical resilient strain found from the primary response model (in./in.).

h= Thickness of the aggregate layer (in.).

ε_r = resilient strain imposed in the lab to find the model parameters (in./in.).

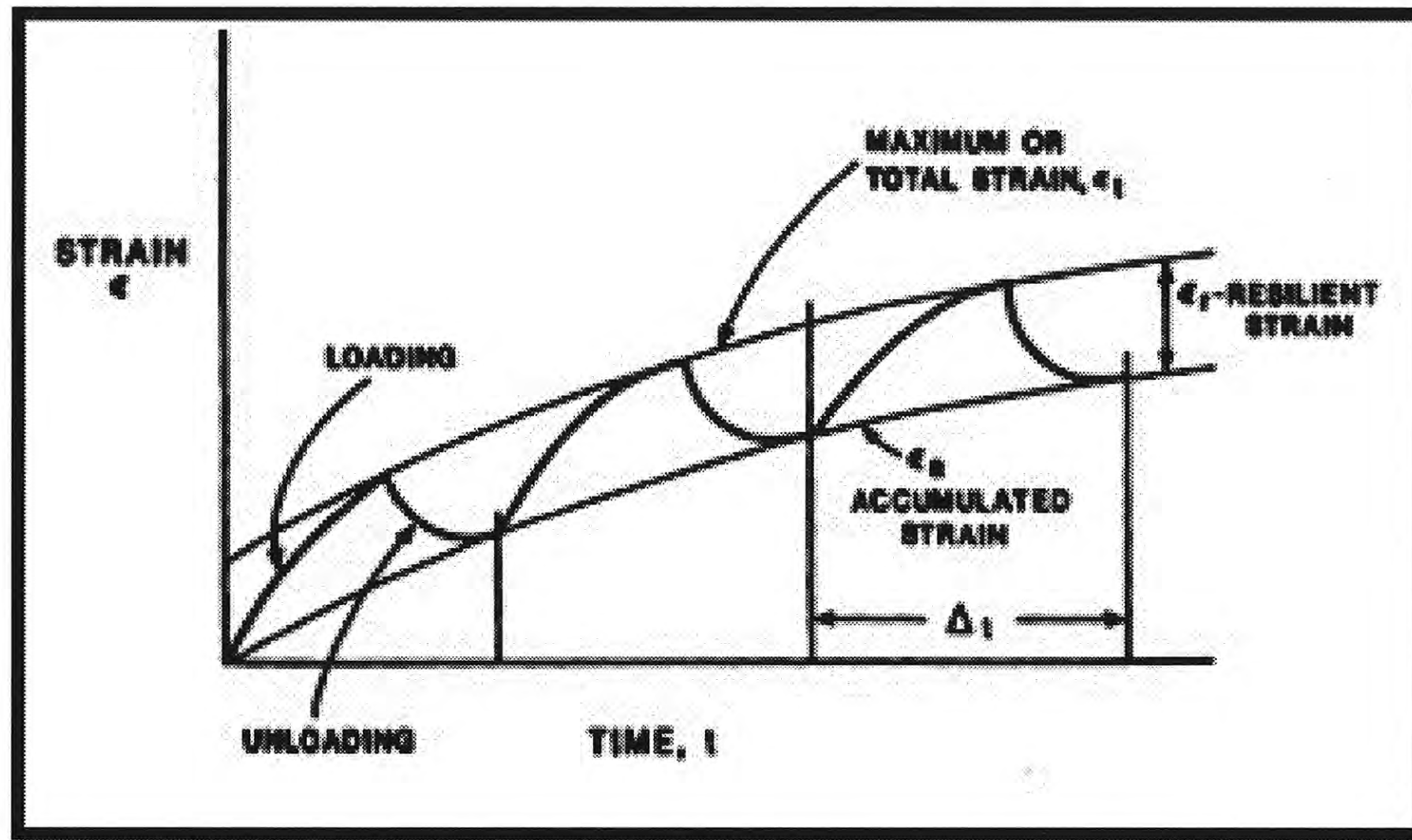

Figure 6.2. Repeated Load-Permanent Deformation Test (after Hoyt et al. 1987).

An alternative mathematical model to the MEPDG permanent deformation model is the VESYS model. The relationship between the number of loading repetitions and plastic deformation is used in the VESYS model. This model calculates the plastic strain in each individual layer in the unbound materials structure. Then the VESYS model sums the plastic strain of each layer to determine the total deformation of the structure:

$$\frac{1}{\varepsilon_r} \frac{\partial \varepsilon^p(N)}{\partial N} = \mu N^{-\alpha} \quad (2)$$

where:

μ = Constant of proportionality between resilient strain and permanent strain at Nth load repetition.

α = Permanent deformation parameter indicating the rate of decrease in permanent deformation as the number of load applications increases.

ε^p = plastic strain.

ε_r = resilient strain.

CONCLUSIONS

As opposed to the acceptance of flexible base construction on density attainment, the ability to link simple index properties through calibrated pavement performance modeling could allow for truly linking field acceptance to design assumptions. Furthermore, such a link could allow for justifiable pay factors based upon expected pavement performance. This idea for linking index tests to mechanical properties should be considered in future work of this project; Appendices A and B detail the tests and technical approach that could be used to achieve this link.

CHAPTER 7. DEVELOPMENT OF DRAFT MIXTURE-BASED SPECIFICATION FOR FLEXIBLE BASE

OVERVIEW

The flexible base specification is the primary product to be produced from this research project. The Project Monitoring Committee (PMC) and industry will review and revise the specification on a continuing basis. Laboratory and field research efforts will be developed and conducted to revise the specification. Implementation of the specification will start at the conclusion of the project. As of this report date, a draft specification has been written and undergone two revisions by the PMC. Appendix C presents the current version of the draft specification.

SELECTION OF TESTS FOR INCLUSION IN SPECIFICATION

Based on the results presented in Chapters 1–6, Tables 7.1–7.4 present the currently recommended tests for aggregate properties, mixture properties, production testing, and placement testing in the draft mixture-based specification. Appendix C presents the current draft mixture-based specification format using these tests.

Table 7.1. Tests for Aggregate Properties.

Test Description	Test Method
Sampling	Tex-400-A
Sample Preparation	Tex-101-E
Liquid Limit	Tex-104-E
Plastic Limit	Tex-105-E
Calculate Plastic Index	Tex-106-E
Linear Shrinkage	Tex-107-E
Sieve Analysis of Soils	Tex-110-E
Wet Ball Mill	Tex-116-E
Sulfate Content	Tex-145-E
Dry Sieve	Tex-200-F, Part I
Wet Sieve	Tex-200-F, Part II
Decantation	Tex-406-A Tex-217-F, Part II
Sulfate Soundness	Tex-411-A
Deleterious Material	Tex-413-A Tex-217-F, Part I
Crushed Faces	Tex-460-A

Table 7.2. Tests for Mixture Properties.

Test Description	Test Method
Moisture Content	Tex-103-E
Moisture Content	Tex-115-E
Moisture Density Relationships	Tex-113-E
Triaxial Compression	Tex-117-E

Table 7.3. Tests for Production Testing.

Test Description	Test Method
Sampling	Tex-100-E
Sampling	Tex-400-A
Sample Preparation	Tex-101-E
Liquid Limit	Tex-104-E
Plastic Limit	Tex-105-E
Calculate Plastic Index	Tex-106-E
Linear Shrinkage	Tex-107-E
Sieve Analysis of Soils	Tex-110-E
Wet Ball Mill	Tex-116-E
Sulfate Content	Tex-145-E
Dry Sieve	Tex-200-F, Part I
Wet Sieve	Tex-200-F, Part II
Decantation	Tex-406-A Tex-217-F, Part II
Sulfate Soundness	Tex-411-A
Deleterious Material	Tex-413-A Tex-217-F, Part I
Crushed Faces	Tex-460-A
Moisture Content	Tex-103-E
Moisture Content	Tex-115-E
Moisture Density Relationship	Tex-113-E
Selecting Random Numbers	Tex-225-F, Part I
Control Charts	Tex-233-F

Table 7.4. Tests for Placement Testing.

Test Description	Test Method
Moisture Content	Tex-103-E
Moisture Density Relationship	Tex-113-E
Field In-Place Density	Tex-115-E
Triaxial Compression	Tex-117-E
Depth	Tex-140-E
Selecting Random Numbers	Tex-225-F, Part II
Control Charts	Tex-233-F

GENERAL CONSIDERATIONS FOR DRAFTING SPECIFICATION

The research team employed the following general considerations for development of the draft specification:

- Write the specification in a quality control/quality assurance format.
- Format the key sections of the specification like other TxDOT specifications.
- Use similar approaches to other TxDOT QC/QA specifications with regard to format, mixture design, approval of mixture designs, insuring quality and pay factors.
- Use as many currently used sampling and testing procedures as possible in the new specification.
- Consider utilization of results from TxDOT research and other research in the specification development.

The format selected for the specification sections is that typically used by TxDOT and provided in Table 7.5 below:

Table 7.5. Major Sections of Specification.

Section	Section Title
1.0	Description
2.0	Materials
3.0	Equipment
4.0	Construction
5.0	Measurement
6.0	Payment

Brief descriptions of the main features of the various sections of the specification (in its present Draft 2.0 form) follow.

Description

No change has been made in this section.

Materials

The specification uses the same Types and Grades designated in the present specification (Item 247). Gradation has been changed from accumulative percent retained to accumulative percent passing. Controls have been placed on the amount and types of finer materials. Sulfate content is specified. The Texas Triaxial Classification method is not used. Recycled portland cement concrete and reclaimed asphalt pavement is allowed. Water quality is specified.

Equipment

Method specification language has been removed from this section of the specification.

Construction

All technicians that sample and test under this specification must be certified. Tests must be performed in a TxDOT approved laboratory. The Contractor performs the mixture design and TxDOT approves the design. Referee testing is allowed.

Minimum requirements for a quality control program are included. Operational tolerances are based on allowable differences from JMF and specification limits. Contractor quality control tests and TxDOT quality assurance tests must be within certain “acceptable limits.” Work can be suspended if the operational tolerances are not met.

Minimum sampling and testing requirements for the contractor and TxDOT are defined. Production and placement pay factors need to be greater than 1.00 for work to continue, and greater than 70 percent or rework or remove/replace may be directed by the Engineer.

Measurement

The measurement methods used in the current specification are used in the draft QC/QA specification.

Payment

The pay “locations” used in the current specification are used in the draft QC/QA specification (roadway, stockpile, etc.). Pay adjustments are separate for “production” and “placement” and are based on Lots and Sublots. Percent within limits based on statistical principals are presently used to determine Pay Adjustment Factors.

CONTINUED DEVELOPMENT OF SPECIFICATION

The specification will continue to be revised based on review and revisions from the Project Monitoring Committee as well as an Industry Working Group, which has been established. Ongoing laboratory and field research efforts will also produce information that will be incorporated into the specification.

CHAPTER 8. CONCLUSIONS AND RECOMMENDATIONS

OVERVIEW

In the first year of this research project, a draft QC/QA specification for flexible base was produced and revised through input of the TxDOT project monitoring committee. Appendix C presents this draft specification. While the current draft largely uses approaches familiar to TxDOT, additional work to better define allowable tolerances is needed. The second year of this project will gather information to identify tolerances that are both achievable in real-world production without compromising the design strength.

RECOMMENDATION FOR SAMPLING AND TESTING

Tables 8.1 and 8.2 present a sampling and testing plan that should enable capturing enough information to quantify daily, weekly, and monthly production variability and establish tolerances that are achievable in the field without compromising the design strength. The sampling plan in Table 8.1 collects 38 samples over a four-month time frame, with instances of as many as five samples collected in a day. The testing plan in Table 8.2 includes all of TxDOT's currently-used tests, along with some non-TxDOT methods. These new methods include the methylene blue value, aggregate imaging, suction-water content curve, and repeated load triaxial testing. The test plan includes the repeated load triaxial to quantify base material performance in a manner suitable for use in pavement performance prediction programs. The aggregate imaging and suction-water content curve are included to investigate if these index tests could be related to the repeated-load performance of the base material as described in Appendix B. The test plan includes the new methylene blue method to investigate if that test could supplement or possibly even replace the Atterberg limits; the literature suggests the methylene blue test relates to performance and may offer better precision and improved turnaround time as compared to liquid and plastic limit procedures.

This sampling and testing should be conducted on quarries representing different operational sizes and rock types around the state in the second year of this project. Currently, the research team has secured participation of eight quarries producing materials ranging from caliche, soft and hard limestone, dolomitic limestone, sandstone, and granite.

Table 8.1. Sampling Plan for Establishing Variability.

Project 0-6621							
Buckets of Base Needed per Sampling*							
Month	Week	Day					Samples/Day
		1	2	3	4	5	
1	1		2				1
	2		2				5
	3		10				3
	4	2	2	2	2	2	1
2	1		2				3
	2		2				1
	3		10				1
	4		2				1
3	1		2				5
	2						0
	3	10	10	10	10	10	1
	4						0
4	1		2				5
	2		2				1
	3		10				1
	4		2				1

* Assumes ~ 50 pounds per bucket



 Test plan A
 Test Plan A & B

Table 8.2. Testing Planned for Development of Acceptable Tolerances.

Test Plan	Tests	Description
A	110-E	Gradation*
	104, 105, 106-E	Atterberg Limits
	116-E	Wet Ball Mill
	145-E	Sulfates
	tbd	Methylene Blue
B	113-E	Moisture-Density
	117-E Pt II	Compressive Strength
	AASHTO TP81	AIMS
	ASTM D 5298	Suction-Water Curve
	AASHTO T307	Repeated Load Triaxial

*1 3/4, 1 1/4, 7/8, 5/8, 3/8, No. 4, No. 40, No. 200

RECOMMENDATION FOR SPECIFICATION REVISION

Currently the research team believes the following major considerations exist for revising the specification:

- The specification must be reviewed by industry and jointly developed with industry input. An Industry Working Group that has already met twice will facilitate these reviews and revisions.
- Operational tolerances that are attainable in production without compromising design strength must be identified. The sampling and testing plan outlined in Tables 8.1 and 8.2 is currently under way to provide the information to identify these tolerances.
- Performance and economic investigation is needed to determine whether restricting the fines content is warranted. The sampling and testing described previously, combined with pavement performance programs and economic analysis techniques, should be used to conduct this investigation.

REFERENCES

1. Scullion, T., W. S. Guthrie, and S. D. Sebesta. Field Performance and Design Recommendations for Full Depth Recycling in Texas. Research Report 0-4182-1, Texas Transportation Institute, College Station, TX, 2003.
2. Garibay, J. L., D. Yuan, S. Nazarian, and I. Abdallah. Guidelines for Pulverization of Stabilized Bases. Research Report 0-5223-2, Center for Transportation Infrastructure Systems, The University of Texas at El Paso, El Paso, TX, 2008.
3. Franco, S., S. P. Moss, D. Yuan, and S. Nazarian. Design, Constructability Review and Performance of Dual Base Stabilizer Applications. Research Report 0-5797-1, Center for Transportation Infrastructure Systems, The University of Texas at El Paso, El Paso, TX, 2009.
4. Gautam, B., D. Yuan, I. Abdallah, and S. Nazarian. Guidelines for Using Local Materials for Roadway Base and Subbase. Research Report 0-5562-1, Center for Transportation Infrastructure Systems, The University of Texas at El Paso, El Paso, TX, 2009.
5. Hefer, A., and T. Scullion. Materials, Specifications, and Construction Techniques for Heavy-Duty Flexible Bases: Literature Review and Status Report on Experimental Sections. Technical Report 0-4358-1, Texas Transportation Institute, College Station, TX, 2005.
6. Williamee, R. S., and G. L. Thomas. Reevaluation of Flexible Base in the Fort Worth District. TxDOT Research Report 7-3931, 2000.
7. Scullion, T., J. P. Harris, S. Sebesta, and S. Nazarian. Heavy-Duty Flexible Bases: Field Performance and Draft Specifications. Technical Report 0-4358-4, Texas Transportation Institute, College Station, TX, 2007.
8. Gandra, J. A., A. Kancherla, G. Alvarado, S. Nazarian, and T. Scullion. Impact of Aggregate Gradation on Base Material Performance. Research Report 4358-2. Center for Transportation Infrastructure Systems, The University of Texas at El Paso, El Paso, TX, 2005.
9. Kancherla, A., and T. Scullion. Heavy-Duty Flexible Bases: Year 3 Progress Report. Technical Report 0-4358-3, Texas Transportation Institute, College Station, TX, 2006.
10. Scullion, T. Item 245: Heavy-Duty Aggregate Base. Product 5-4358-01-P2, Texas Transportation Institute, College Station, TX, 2007.

11. Reyes, J., E. Mahmoud, I. Abdallah, E. Masad, S. Nazarian, R. Langford, and V. Tandon. Quantifying the Role of Coarse Aggregate Strength on Resistance to Load in HMA. Research Report 0-5368-2, Center for Transportation Infrastructure Systems, The University of Texas at El Paso, El Paso, TX, 2008.
12. Sebesta, S., T. Scullion, D. Rich, and W. Liu. New Technologies for Measuring Pavement Quality. Report 0-4774-S, Texas Transportation Institute, College Station, TX, 2006.
13. Sebesta, S., T. Scullion, and W. Liu. Pilot Implementation of Instrumented Rollers for Monitoring Flexible Pavement Construction. Technical Report 5-4774-01-1, Texas Transportation Institute, College Station, TX, 2008.
14. FHWA, *User Guidelines for Waste and Byproduct Materials in Pavement Construction*, Publication No. FHWA-RD-97-148, Federal Highway Administration, Washington, DC, 1997.
<http://www.fhwa.dot.gov/publications/research/infrastructure/structures/97148/rap134.cfm>.
15. Collins, R. J., and S. K. Ciesielski. *Recycling and Use of Waste Materials and By-Products in Highway Construction*, Synthesis of Highway Practice 199, National Cooperative Highway Research Program, Transportation Research Board, Washington, DC, 1994.
16. Yuan, D., S. Nazarian, L. R. Hoyos, and A. J. Puppala. "Evaluation and Mix Design of Cement-Treated Base Materials with High RAP Content," Proceedings (CD), 90th Annual Meeting, Transportation Research Board, Washington, DC, 2011.
17. Saeed, A. *Performance-Related Tests of Recycled Aggregates for Use in Unbound Pavement Layers*, NCHRP Report 598, National Cooperative Highway Research Program, Transportation Research Board, Washington, DC, 2008.
18. Senior, S. A., S. I. Szoke, and C. A. Rogers. "Ontario's Experience with Reclaimed Materials for Use in Aggregates," presented at the International Road Federation Conference, Calgary, Alberta, 1994.
19. Bennert, T., and A. Maher. "The Development of a Performance Specification for Granular Base and Subbase Material," Report No. HWA-NJ-2005-003, New Jersey Department of Transportation, Trenton, NJ, 2005.

20. Mokwa, R. L., and C. S. Peebles. "Evaluation of the Engineering Characteristics of RAP/Aggregate Blends," Report No. FHWA/MT-05-008/8117-24, Department of Civil Engineering, Montana State University, Bozeman, MT, 2005.
http://www.mdt.mt.gov/research/docs/research_proj/rap_aggregate/final_report.pdf.
21. Kim, W., J. F. Labuz, and S. Dai. "Resilient Modulus of Base Course Containing Recycled Asphalt Pavement," *Transportation Research Record No. 2006*, Transportation Research Board, 2007, pp. 27–35.
22. Guthrie, W. S., D. Cooley, and D. L. Eggett. "Effects of Reclaimed Asphalt Pavement on Mechanical Properties of Base Materials," *Transportation Research Record No. 2006*, Transportation Research Board, 2007, pp. 44–52.
23. Hanks, A. J., and E. R. Magni. *The Use of Bituminous and Concrete Material in Granular and Earth*, Materials Information Report MI-137, Engineering Materials Office, Ontario Ministry of Transportation, Downsview, Ontario, 1989.
24. Bennert, T., W. J. Papp, A. Maher, and N. Gucunski. "Utilization of Construction and Demolition Debris under Traffic-Type Loading in Base and Subbase Applications," *Transportation Research Record 1714*, Transportation Research Board, 2000, pp. 33–39.
25. FHWA, *Engineering and Environmental Aspects of Recycling Materials for Highway Construction*, Federal Highway Administration, Report No. FHWA-RD-93-008, Washington, DC, 1993.
26. FHWA, *Summary of Virginia Recycled Concrete Aggregate Review*, Federal Highway Administration, Washington, DC, 2003.
<http://www.fhwa.dot.gov/pavement/recycling/rcava.cfm>.
27. Hillier, S. R., C. M. Sangha, B. A. Plunkett, P. J. Walden. "Long-Term Leaching of Toxic Trace Metals from Portland Cement Concrete," *Cement and Concrete Research*, Vol. 29, 1999, pp. 515–521.
28. Kim, W., and J. F. Labuz. "Resilient Modulus and Strength of Base Course with Recycled Bituminous Material," Report No. MN/RC-2007-05, Department of Civil Engineering, University of Minnesota, Minneapolis, MN, 2007. <http://www.lrrb.org/pdf/200705.pdf>.
29. Martin, D. V., G. W. Halsey, and J. S. Melton. "Comparison of Building Derived Aggregate in Comparison to Crushed Stone," Proceedings of the Transportation Research Board Annual Meeting, National Academy of Sciences, 2011.

30. Fernando, E. G., R. S. Walker, and C. K. Estakhri. "Flexible Base Ride Specification Development and Evaluation," Report No. FHWA/TX-08/0-4760-1, Texas Transportation Institute, Texas A&M University, College Station, TX, 2007.

APPENDIX A. TESTS FOR DEVELOPING PERFORMANCE-BASED PAY FACTORS

Particle Size Distribution (Gradation Test)

Aggregate Split-A will be employed to perform tests to estimate the material properties of the aggregate at the laboratory. First, a gradation test will determine the particle size distribution in Split-A. The standard test procedure for the particle size analysis is given in Tex 110-E, Part I.



Figure A.1. Sieves and Sieve Shaker for Tex-110-E.

Split-A will then be divided based on the distribution of the particle sieve sizes larger than the No. 4 sieve and smaller than the No. 40 sieve. The diameter corresponding to 60 percent finer in the particle-size distribution, D_{60} , and percent passing No. 200 sieve, P_{200} , are obtained through the gradation that is plotted based on the sieve analysis test.

Aggregate Imaging System (AIMS)

The Aggregate Imaging System (AIMS) is a precise laboratory device to determine coarse aggregate physical characteristics including shape, angularity and surface texture. All of

these characteristics are captured by AIMS for aggregates sized 37.5 mm to 150 mm (Masad 2004). The standard test method for the AIMS is given in AASHTO TP 81 and AASHTO PP 64.

The Weibull shape parameter for gradation curve, S_{Grad} , Weibull shape parameter for aggregate shape distribution curve, S_{Shape} , and Weibull shape parameter for aggregate angularity distribution curve, $S_{Angularity}$, are three parameters obtained by using AIMS.

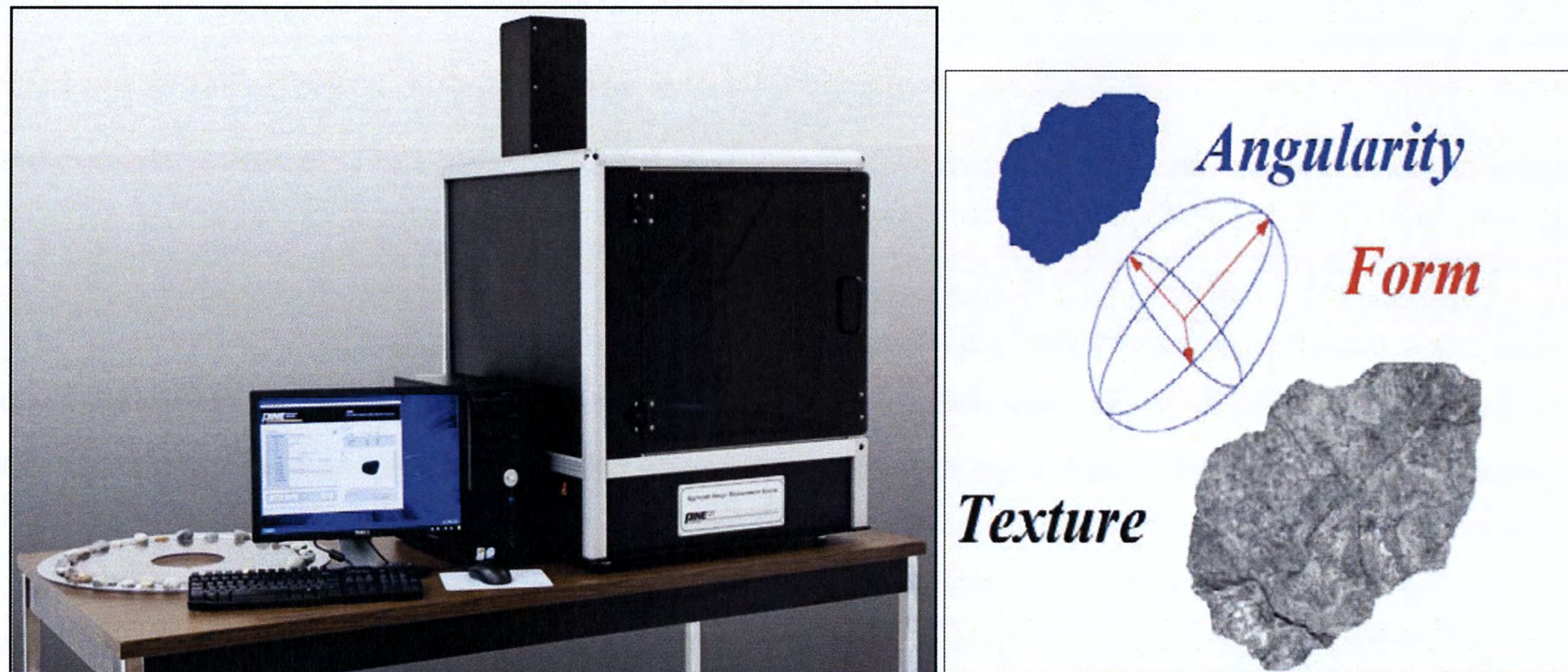

Figure A.2. AIMS Apparatus Shown (Left) and Texture, Angularity, and Form of an Aggregate Illustrated (Right).

Split-A will have two sub-splits called Split-A1 and Split-A2. These are retained on the No.4 sieve and passing the No. 40 sieve, respectively. Thus, Split-A1 consists of larger aggregate and will be used to estimate shape, texture, and angularity of the aggregate.

Atterberg Limit Test

The Atterberg Limit test is a standard test to determine liquid limit and plasticity index of the sample. The liquid limit (LL) is the water content of a soil at the boundary between the liquid and plastic states and is expressed as percentage. The plastic limit (PL) is the water content of a soil at the boundary between plastic state and semi-solid state and is expressed as percentage. Plasticity Index is a boundary in which soil remains plastic and is numerically the difference between the liquid limit and the plastic limit. Tex 104-E and Tex 105-E, respectively, determine the liquid and plastic limit. Tex-106-E determines the PI. Figure A.3 shows the test device.



Figure A.3. Hand-Operated Liquid Limit Device.

The Split-A2 portion of aggregate is used for a series of tests such as the Atterberg limit, the moisture content test, the suction test, and the methylene blue test. The moisture content test procedure is given in Tex-103-E.

W. R. Grace Methylene Blue (WR Grace MB Test)

W. R. Grace recently developed a new methylene blue test to measure the amount of methylene blue dye adsorbed onto clay using colorimetry. The Grace method is a rapid technique to determine the methylene blue value. This method tests the size fraction passing the No. 40 sieve and provides a faster turnaround time than AASHTO T 330. It is portable since no titration apparatus is required. Figure A.4 illustrates the steps of this test.

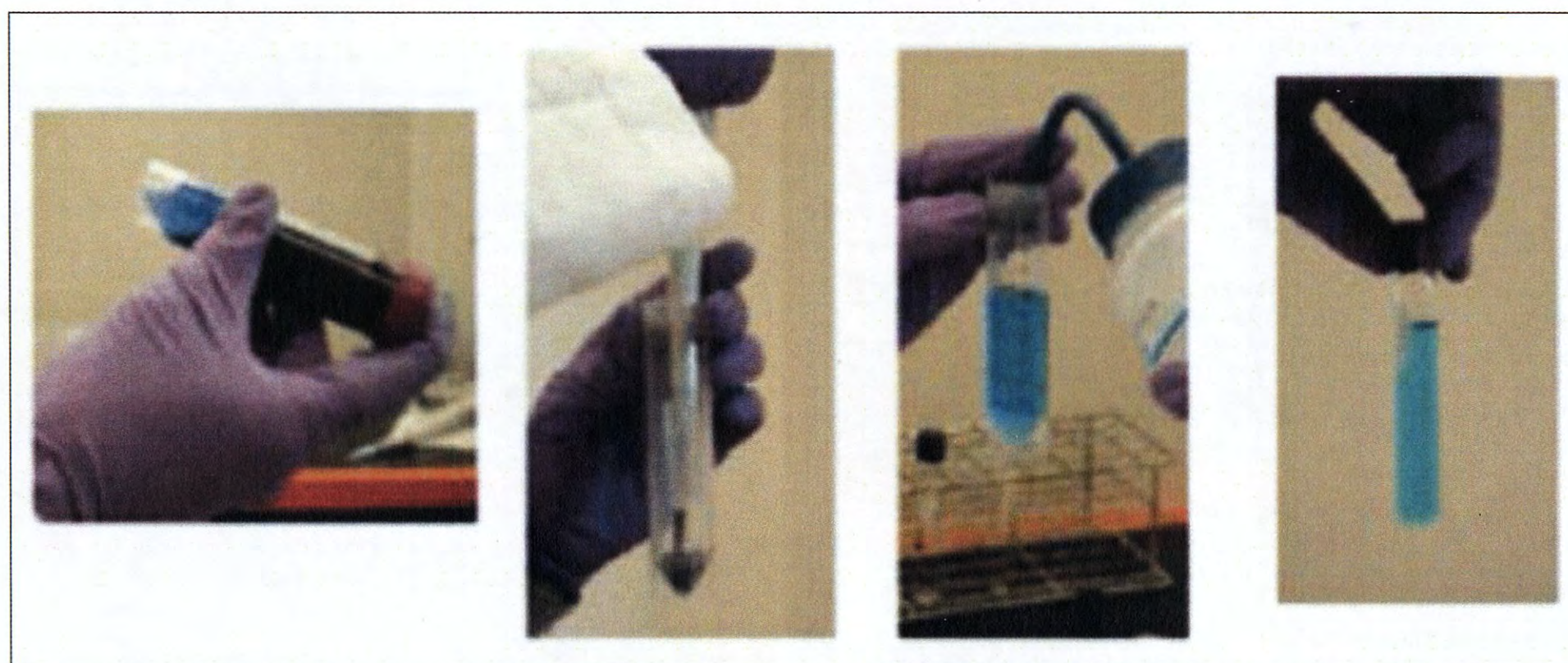

Figure A.4. W. R. Grace Methylene Blue Test (W. R. Grace and Co.).

The WRG Methylene Blue test estimates the percent of the fine fraction. The Grace Methylene Blue value will provide the percentage passing the 2 μm size, and then the ratio of the passing No. 200 sieve to the percent passing the 2 μm size will be used as an input parameter for determining the SWCC.

Filter Paper Suction Test

ASTM D 5290 measures soil suction by filter paper. Figure A.5 illustrates the basic test arrangement. Both total and matrix suction can be determined with this test. For matrix suction measurement, the filter paper is placed between two samples. When the samples reach equilibrium, the suction in the sample and filter papers will be equal. In this project, the prepared base mixture will be used to estimate the suction at the present water content.

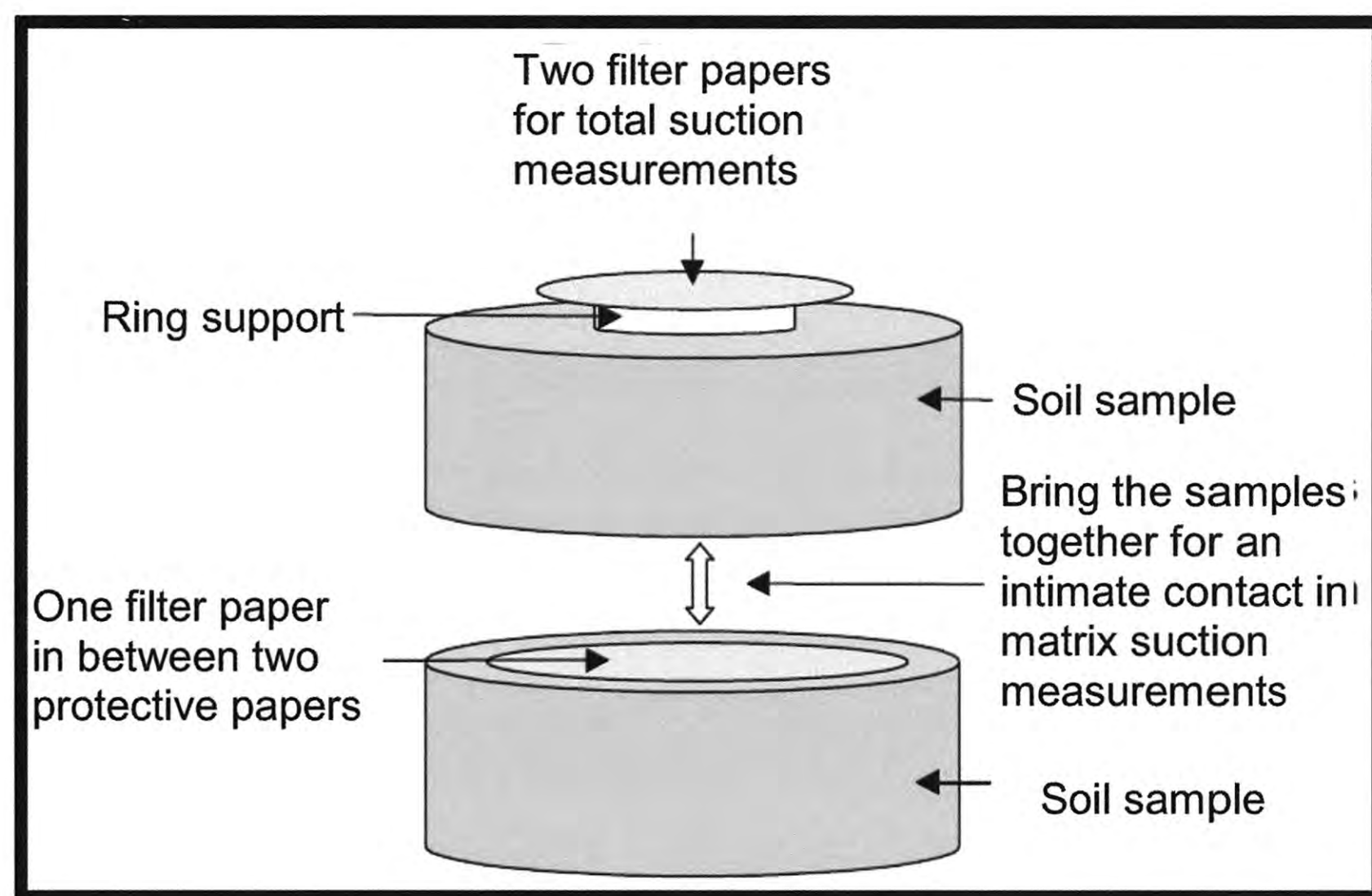

Figure A.5. Soil Samples and Filter Papers for Matrix and Total Suction (Lytton et al. 2004).

Mid Plane Suction Test

The GDS Mid Plane provides a direct measurement of the soil suction. The device uses a high air entry porous disk to measure suction for unsaturated soils. The response time of the

device is less than 3 seconds when the tip is fully saturated. Figure A.6 shows the mid plane suction probe.

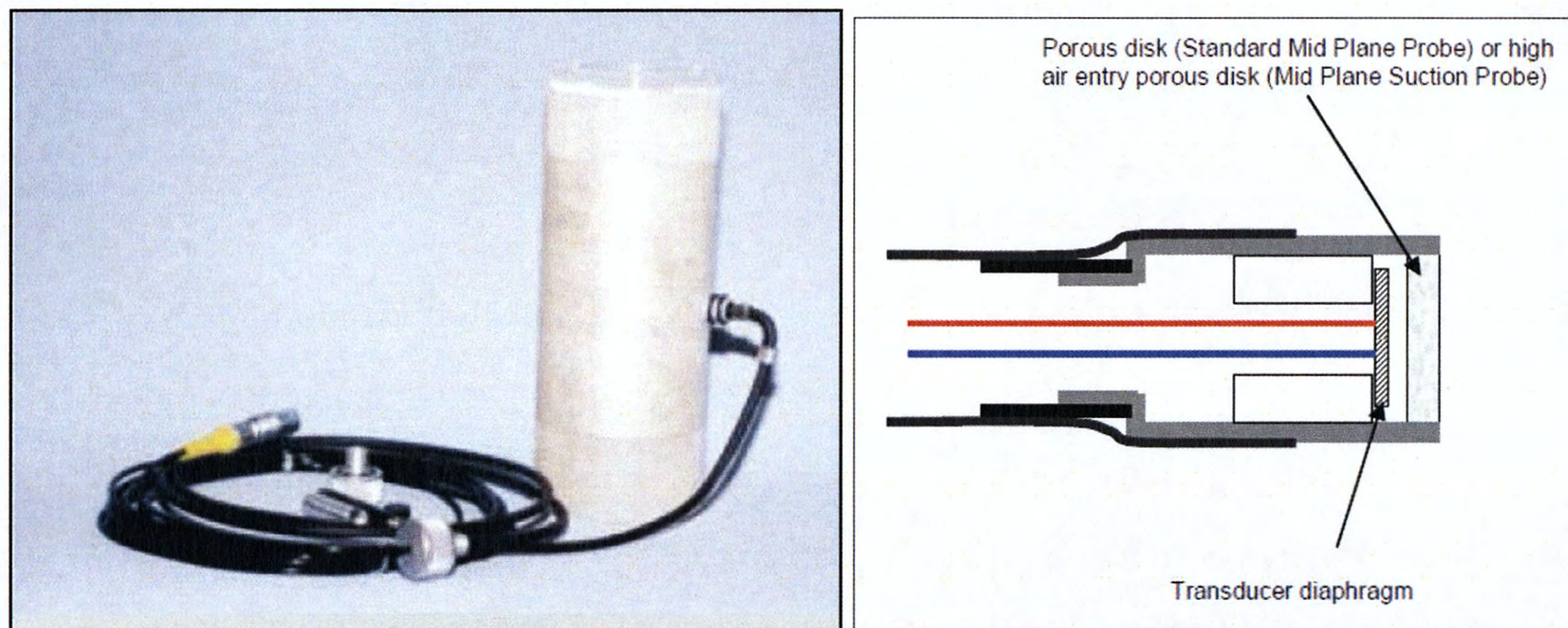

Figure A.6. Mid Plane Suction Probe and the Porous Tip Schematic.
(www.gdsinstruments.com, May 2011).

Repeated Load Triaxial Test

The Repeated Load Triaxial Test determines the Resilient Modulus (M_r) for untreated bases/subbases. A standard Repeated Load Triaxial test will be performed on laboratory compacted samples. A closed-loop pneumatic or hydraulic test frame applies a compression load in a cyclic manner on a specimen. During the cyclical loading, varying confining pressures and deviator stresses are applied to the specimen. The standard method of the tests for determining the resilient modulus of soils and aggregate materials is given in AASHTO T 307. Figure A.7 illustrates the basic test setup.

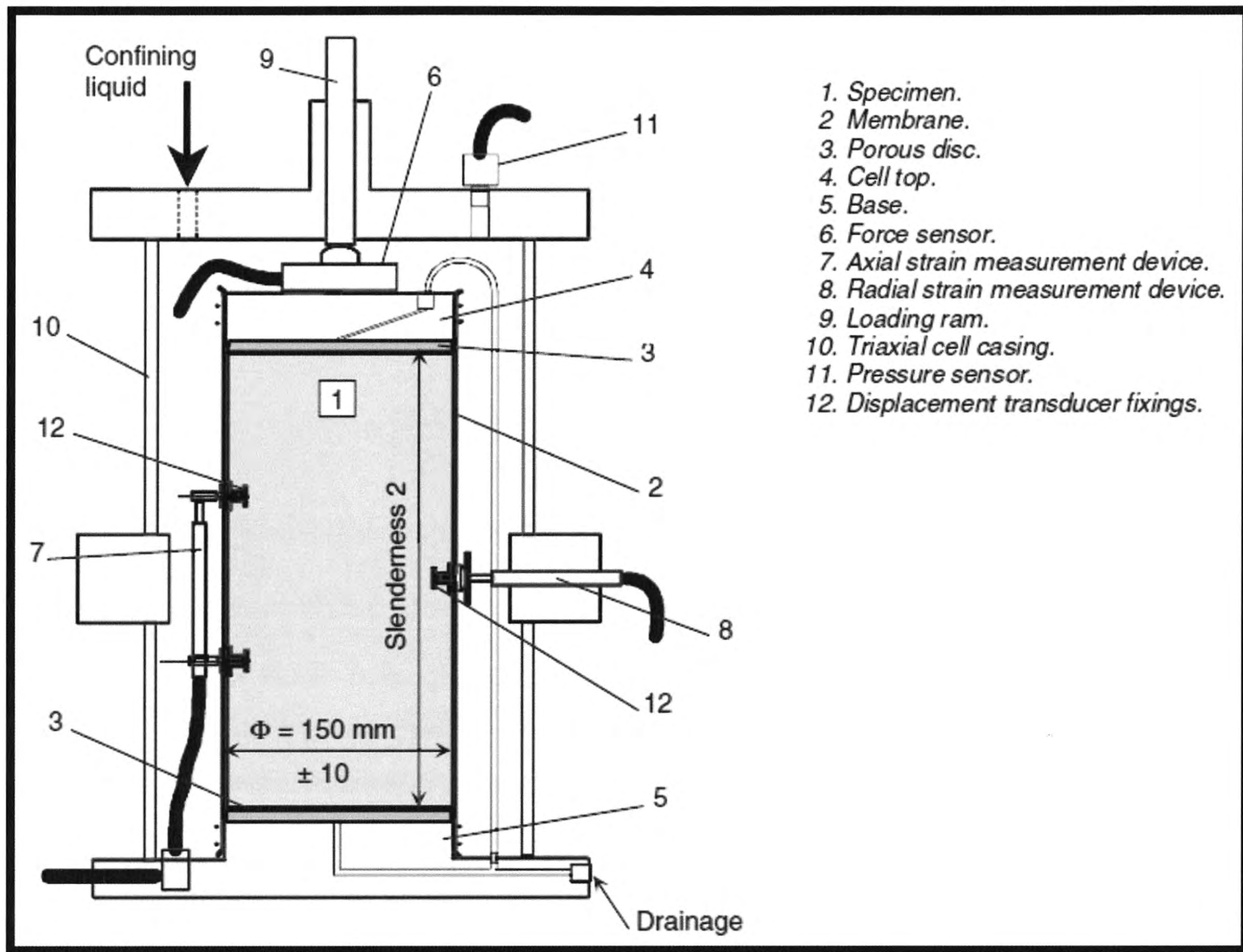

Figure A.7. The Repeated Load Triaxial Test Apparatus (Gidel et al. 2001).

Water Content Test

Water content will be determined using Test Method Tex-103-E for samples both from Split A2 and Split B.

APPENDIX B.
TECHNICAL APPROACH FOR PAY FACTOR DETERMINATION:
PREDICTING MODULI OF ANISOTROPIC UNBOUND
AGGREGATE BASE

INTRODUCTION

The mechanical properties of unbound aggregate base in pavement structures significantly depend on the pore water pressure in the unbound aggregate system. The pore water pressure refers to the stress in the water held within the aggregate base. Since the aggregate base is compacted in an unsaturated condition, the pore water pressure is negative, which is tensile. The tension in the water pulls the base course particles together, increases the interparticle stress and makes the base course stiffer. The pore water pressure can be quantified in terms of suction, which is a measure of the affinity of the aggregate system for water. Generally, an aggregate system with lower water content has a higher suction value. The suction value of the aggregate base significantly influences the base modulus, which is the most important property of the aggregate base in terms of the stress, strain, and permanent deformation characteristics of the entire pavement structure.

The Texas Transportation Institute has been leading the research on predicting the modulus of the aggregate systems based on the stress state, suction level, and aggregate characteristics (Lytton 1995; Park 2000; Ashtiani 2009; Ashtiani and Little 2009; Ashtiani et al. 2010). TTI's research efforts on this topic have not only evaluated the effect of pore water pressure on aggregate base properties but also demonstrated the anisotropic nature of the unbound aggregate base. This White Paper will summarize the latest laboratory testing, data analysis and model development for unbound aggregate systems that have been performed at TTI.

The Minnesota Department of Transportation (MnDOT) have implemented some of TTI's research findings on this topic in their pavement design, quality control (QC) process, and quality assurance (QA) process (Siekmeier 2011). The MnDOT has generated a family of the soil water characteristic curves (SWCC) for typical soils in Minnesota based on the plastic limit of the soils. The soil suction is then predicted using the SWCC and the measured soil properties. The soil suction prediction is coupled with the laboratory resilient modulus testing and the

lightweight deflectometer (LWD) testing results in the field to determine the modulus of the unbound aggregate base.

LABORATORY TEST

A series of tests have been conducted on individual aggregate particles and aggregate mixtures with different gradations and water contents. Various types of aggregates were selected nationwide for the proposed tests, including Texas limestone, Texas gravel, Minnesota gravel, California granite, and others. The procedure and results of each test are detailed as follows.

Characterization of Aggregate Particle Geometry

The geometry of individual aggregate particles was characterized using the Aggregate Imaging System (AIMS) in terms of angularity, shape, and texture. For each aggregate type, aggregate particles randomly selected from three sieve sizes were tested using the AIMS device for their geometric parameters (angularity, shape, and texture). The distribution of each measured geometric parameter was fitted to a cumulative Weibull distribution with a shape parameter a and a scale parameter λ . Table B.1 presents an example of the parameters a and λ of the aggregate particles retained on the $\frac{3}{8}$ in. sieve.

Table B.1. Weibull Distribution Parameters of Aggregate Geometric Characteristics (after Ashtiani 2009).

Aggregate Type	Sieve Size	Angularity		Shape		Texture	
		Shape Parameter (a_A)	Scale Parameter (λ_A)	Shape Parameter (a_S)	Scale Parameter (λ_S)	Shape Parameter (a_T)	Scale Parameter (λ_T)
Texas Limestone	No. 3/8	3.37	3310.31	4.72	6.91	3.06	236.40
Texas Gravel		4.82	3212.25	4.96	7.73	2.71	170.19
Minnesota Gravel		3.36	2918.71	4.21	7.31	2.00	108.82
California Granite		5.65	3231.94	4.45	8.08	3.76	391.17

Physical Properties of Aggregate Matrixes

Each of the four types of aggregates was used to make aggregate matrixes with three different gradations (coarse, intermediate, and fine) and three different moisture states (dry of optimum, optimum, and wet of optimum). Each gradation was fitted to a cumulative Weibull distribution with the shape and scale parameters shown in Table B.2. The Methylene Blue Test (ASTM C832-2003) was used to measure the activity of the fine particles in the matrix. Table B.3 presents the measured Methylene Blue values, dry density, and water content and percent fines passing the No. 200 sieve.

Table B.2. Weibull Distribution Parameters of Aggregate Matrix Gradation.

Aggregate Gradation	Weibull Distribution Shape Parameter (a_G)	Weibull Distribution Scale Parameter (λ_G)
Coarse	0.98	14.7
Intermediate	0.87	12.07
Fine	0.76	8.8

Table B.3. Properties of Aggregate Matrixes (after Ashtiani 2009).

Aggregate Type	Moisture State	Gradation	Dry Density (γ_d, kg/m³)	Water Content (ω, %)	Methylene Blue Value (MBV)	Percent Fines (%)
Texas Limestone	Optimum	Coarse	2144	2.8	9.2	7
	Dry of Optimum	Intermediate	2260	3.5	9.2	10
	Optimum	Intermediate	2350	4.1	9.2	10
	Wet of Optimum	Intermediate	2315	4.9	9.2	10
	Dry of Optimum	Fine	2251	4.7	9.2	20
	Optimum	Fine	2302	5.4	9.2	20
	Wet of Optimum	Fine	2234	5.9	9.2	20
Texas Gravel	Optimum	Coarse	2020	5.5	4.3	7
	Dry of Optimum	Intermediate	2062	5.5	4.3	10
	Optimum	Intermediate	2240	7.7	4.3	10
	Dry of Optimum	Fine	2075	5.4	4.3	20
	Optimum	Fine	2210	7.5	4.3	20
Minnesota Gravel	Dry of Optimum	Intermediate	2139	4.5	8.7	10
	Optimum	Intermediate	2167	6.2	8.7	10
	Wet of Optimum	Intermediate	2240	7.7	8.7	10
	Dry of Optimum	Fine	2159	4.7	8.7	20
	Optimum	Fine	2296	7.6	8.7	20
California Granite	Dry of Optimum	Intermediate	2179	3.5	7.9	10
	Optimum	Intermediate	2218	4	7.9	10
	Wet of Optimum	Intermediate	2192	4.6	7.9	10
	Dry of Optimum	Fine	2177	4.1	7.9	20
	Optimum	Fine	2215	4.6	7.9	20
	Wet of Optimum	Fine	2278	5.9	7.9	20

Triaxial Test on Aggregate Matrixes

Every aggregate matrix was tested for their moduli at 10 combinations of confining pressure and dynamic axial stress using the Rapid Triaxial Test (RaTT) Cell that is mounted on the Universal Testing Machine (UTM). Figure B.1 illustrates the configuration of this triaxial test. During the test, the RaTT Cell moved downward to hold the specimen; then the pressure inside the shell of the RaTT Cell was increased. This confining pressure was applied to the specimen through a membrane. At the same time, the UTM applied an axial load to the specimen through the loading frame. The entire testing process was controlled by a computer using programs that controlled the axial load and the confining pressure. During each test, the Linear Variable Differential Transformers (LVDTs) attached to the specimen measured the vertical and horizontal deformations of the specimen. The moduli and Poisson's ratio were then calculated using the stresses and measured deformations at every stress state. Table B.4 shows an example of the test results on the Texas limestone which had the intermediate gradation and dry moisture state. The notations used in Table B.4 are listed as follows:

- σ_1 is the axial load that the UTM applied to the specimen in the vertical direction.
- σ_3 is the confining pressure the RaTT Cell applied to the specimen through the membrane in contact with the side surface of the specimen.

- I_1 is first invariant of the stress tensor, $I_1 = \sigma_1 + \sigma_2 + \sigma_3$.

- τ_{oct} is the shear stress on the octahedral plane,

$$\tau_{oct} = \frac{1}{3} \sqrt{(\sigma_1 - \sigma_2)^2 + (\sigma_2 - \sigma_3)^2 + (\sigma_3 - \sigma_1)^2} .$$

- E_y is the modulus of the aggregate matrix in the vertical direction.
- E_x is the modulus of the aggregate matrix in the horizontal direction.
- G_{xy} is the shear modulus of the aggregate matrix.
- ν_{xy} is the Poisson's ratio of the aggregate matrix in the vertical plane.
- ν_{xx} is the Poisson's ratio of the aggregate matrix in the horizontal plane.

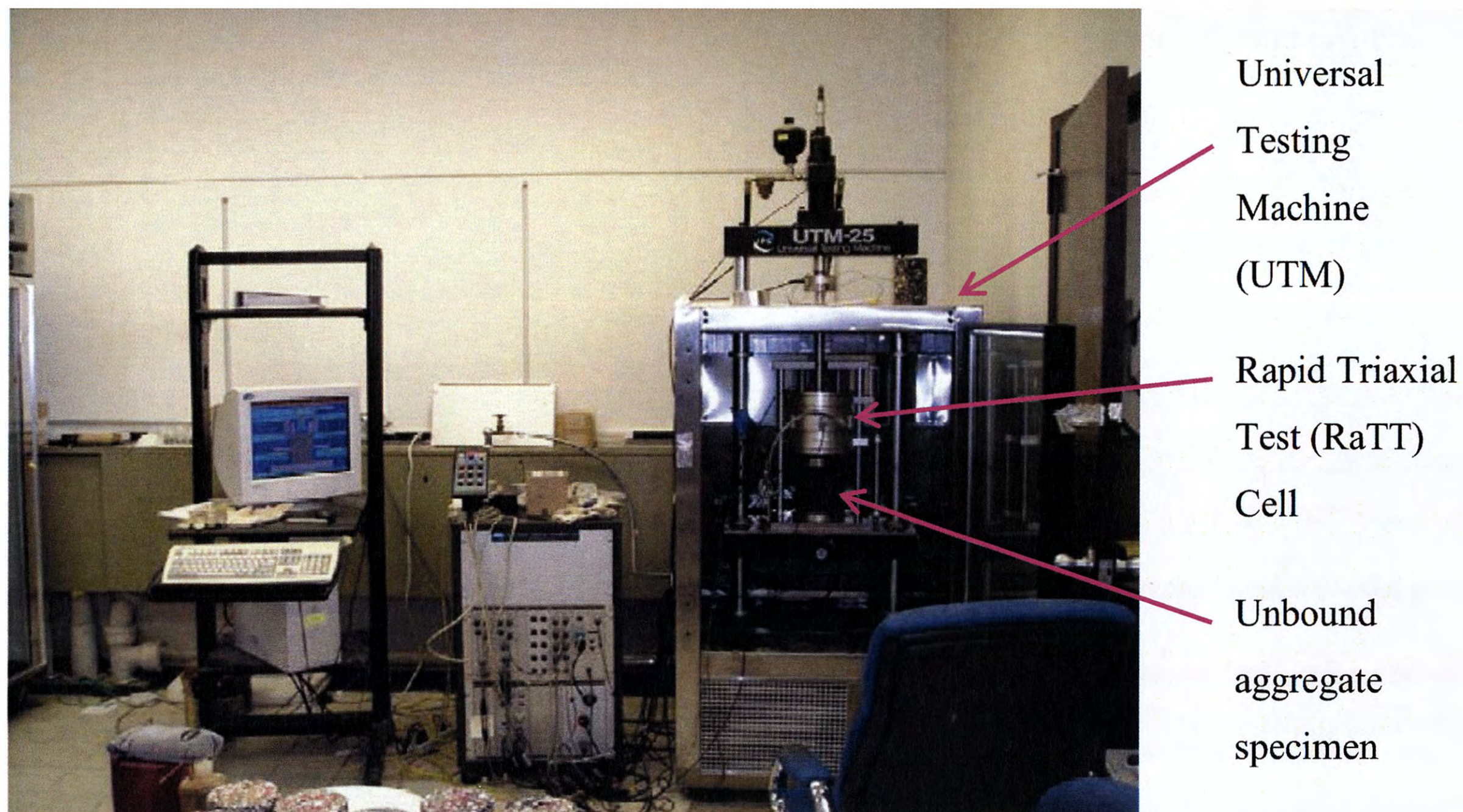

Figure B.1. Configuration of Rapid Triaxial Test.

Table B.4. Example Test Results of Rapid Triaxial Test.

σ_1 (kPa)	σ_3 (kPa)	$\sigma_1 \cdot \sigma_3$	I_1 (kPa)	τ_{oct} (kPa)	E_y (MPa)	E_x (MPa)	G_{xy} (MPa)	ν_{xy}	ν_{xx}
40	25	15	90	7.07	144.0	68.1	40.1	0.173	0.403
50	25	25	100	11.79	177.3	72.0	49.7	0.180	0.350
70	40	30	150	14.14	237.7	128.0	81.9	0.202	0.373
130	60	70	250	33.00	393.3	160.0	107.7	0.180	0.414
150	70	80	290	37.71	447.7	200.7	130.3	0.181	0.404
170	100	70	370	33.00	460.3	275.7	164.0	0.216	0.405
220	120	100	460	47.14	543.3	311.0	182.7	0.196	0.407
250	140	110	530	51.85	592.3	377.3	215.3	0.189	0.414
250	120	130	490	61.28	604.3	329.7	199.7	0.182	0.392
250	105	145	460	68.35	625.3	296.3	185.7	0.166	0.425

As shown in Table B.4, the vertical modulus (E_y), horizontal modulus (E_x), and shear modulus (G_{xy}) vary with the stress level, demonstrating that the moduli of the aggregate matrix are stress-independent. At each stress state, the vertical modulus is significantly larger than the horizontal modulus, which demonstrates the strong anisotropic nature of unbound aggregate systems.

MODELING OF TESTING DATA

A set of mechanistic models was developed to model the moduli of the aggregate matrix at a known water content and gradation. This set is shown in Equations 1 to 3:

$$E_y = k_1 P_a \left[\frac{I_1 - 3\theta f \left(h_m + \beta \frac{I_1}{3} + \alpha \tau_{oct} \right)}{P_a} \right]^{k_2} \left(\frac{\tau_{oct}}{P_a} \right)^{k_3} \quad (1)$$

$$E_x = k_4 P_a \left[\frac{I_1 - 3\theta f \left(h_m + \beta \frac{I_1}{3} + \alpha \tau_{oct} \right)}{P_a} \right]^{k_5} \left(\frac{\tau_{oct}}{P_a} \right)^{k_6} \quad (2)$$

$$G_{xy} = k_7 P_a \left[\frac{I_1 - 3\theta f \left(h_m + \beta \frac{I_1}{3} + \alpha \tau_{oct} \right)}{P_a} \right]^{k_8} \left(\frac{\tau_{oct}}{P_a} \right)^{k_9} \quad (3)$$

where:

I_1 = first invariant of the stress tensor.

P_a = atmospheric pressure.

θ = volumetric water content.

h_m = initial matrix suction in the aggregate matrix.

f = saturation factor, $1 \leq f \leq \frac{1}{\theta}$.

τ_{oct} = octahedral shear stress.

α and β = pore water pressure parameters.

$k_1, k_2, k_3, k_4, k_5, k_6, k_7, k_8,$ and k_9 = material parameters that are dependent on material properties dry unit weight, water content, Methylene Blue Value, and aggregate gradation, angularity, shape and texture.

During the modeling process, θ and f were first calculated based on the dry density (γ_d) and water content (ω). Then the Solver Function in Microsoft Excel™ was used to search for $h_m, \alpha, \beta,$ and k values while minimizing the fitting error. The modeling results show that the

average R-squared value of all data sets was 0.976, which demonstrates the goodness of the model fit. For example, when fitting the test data in Table B.4 to Equations 1 to 3, θ and f were first determined based on the dry density (2260 kg/m^3) and water content (3.5%) to be 0.0791 and 1, respectively. Then the Solver Function in Excel was used to search for the best values of h_m , α , β , and k , which were determined to be: $h_m = -2354.99$, $\alpha = 3.92$, $\beta = 10.84$, $k_1 = 19.59$, $k_2 = 3.50$, $k_3 = 0.65$, $k_4 = 4.13 \times 10^{-5}$, $k_5 = 10.70$, $k_6 = 0.69$, $k_7 = 0.0021$, $k_8 = 8.13$, and $k_9 = 0.66$. The R-squared values of Equations 1 to 3 were 0.994, 0.983, and 0.984, respectively. Table B.5 summarizes the predicted matrix suction for all tested aggregate matrixes and the R-squared values of the models. The initial matrix suction of the aggregate matrix was always negative since the aggregate system was unsaturated when it was compacted. For the same aggregate type with the same gradation, higher water content was usually associated with less negative initial matrix suction. The matrix suction term is essential to Equations 1 to 3. When the pore water pressure component ($3\theta f \left(h_m + \beta \frac{I_1}{3} + \alpha \tau_{oct} \right)$) was excluded from the models, the R-squared values decreased significantly and the modulus was overestimated. The overestimation of the modulus is illustrated in Figure B.2 in terms of the increase of the hardening component,

$$\left[\frac{I_1 - 3\theta f \left(h_m + \beta \frac{I_1}{3} + \alpha \tau_{oct} \right)}{P_a} \right]^{k_2}, \text{ with depth within a 10 in. thick base course.}$$

Table B.5. Predicted Matrix Suction and R-Squared Value of Mechanistic Models.

Aggregate Type	Moisture State	Gradation	Predicted Matrix Suction (kPa)	R-Squared Value		
				E_y	E_x	G_{xy}
Texas Limestone	Optimum	Coarse	-1209	0.994	0.984	0.988
	Dry of Optimum	Intermediate	-2355	0.994	0.983	0.984
	Optimum	Intermediate	-2168	0.993	0.992	0.991
	Wet of Optimum	Intermediate	-1268	0.994	0.982	0.990
	Dry of Optimum	Fine	-3128	0.997	0.989	0.987
	Optimum	Fine	-1803	0.865	0.931	0.958
	Wet of Optimum	Fine	-1720	0.990	0.979	0.982
Texas Gravel	Optimum	Coarse	-2226	0.993	0.967	0.972
	Dry of Optimum	Intermediate	-2401	0.982	0.976	0.976
	Optimum	Intermediate	-1519	0.991	0.984	0.975
	Dry of Optimum	Fine	-3847	0.984	0.938	0.953
	Optimum	Fine	-3742	0.994	0.880	0.929
Minnesota Gravel	Dry of Optimum	Intermediate	-2089	0.992	0.984	0.980
	Optimum	Intermediate	-1928	0.993	0.985	0.983
	Wet of Optimum	Intermediate	-1011	0.993	0.961	0.975
	Dry of Optimum	Fine	-3104	0.990	0.975	0.979
	Optimum	Fine	-2014	0.996	0.911	0.929
California Granite	Dry of Optimum	Intermediate	-4440	0.992	0.981	0.978
	Optimum	Intermediate	-2749	0.991	0.981	0.982
	Wet of Optimum	Intermediate	-2097	0.993	0.981	0.982
	Dry of Optimum	Fine	-3399	0.993	0.987	0.983
	Optimum	Fine	-2933	0.987	0.948	0.963
	Wet of Optimum	Fine	-2747	0.997	0.984	0.985

As shown in Figure B.2, when addressing the effect of pore water pressure, the predicted hardening component is significantly smaller than that without the pore water pressure component. A smaller hardening component indicates a lower value of the predicted vertical modulus. In other words, not considering the pore water pressure overestimates the vertical modulus, which is not conservative in pavement design. The pore water pressure is important in determining the stiffness of the aggregate system and varies with the stress level that is applied by passing traffic to the aggregate system. When the compaction of an unbound aggregate base has just been completed and is tested for stiffness in the field, the stress within the aggregate base is due to the weight of the base course itself and to the tension in the pore water. The modulus of the aggregate base varies with the pore water pressure in the aggregate system. Figure B.3 shows the vertical moduli of the Texas limestone base without external load at combinations of

different levels of pore water pressure and k_2 values. At a specific k_2 value, the vertical modulus of the aggregate base decreases as the pore water pressure increases (or becomes less negative). If traffic load is applied to the aggregate base, the pore water pressure may build up to a positive (or compressive) level. As a result, the vertical modulus of the aggregate base will decrease as the pore water pressure increases. Figure B.4 illustrates the vertical moduli of the same Texas limestone base under different levels of tire pressure. These are the instantaneous vertical moduli of the aggregate base when the tire is passing directly over the base. After the traffic load is removed, the modulus of the base will recover at different rates that depend on the percentage and type of fines in the aggregate system. The percent and water retention of the fines in the base course is reliably indicated by the Methylene Blue Value.

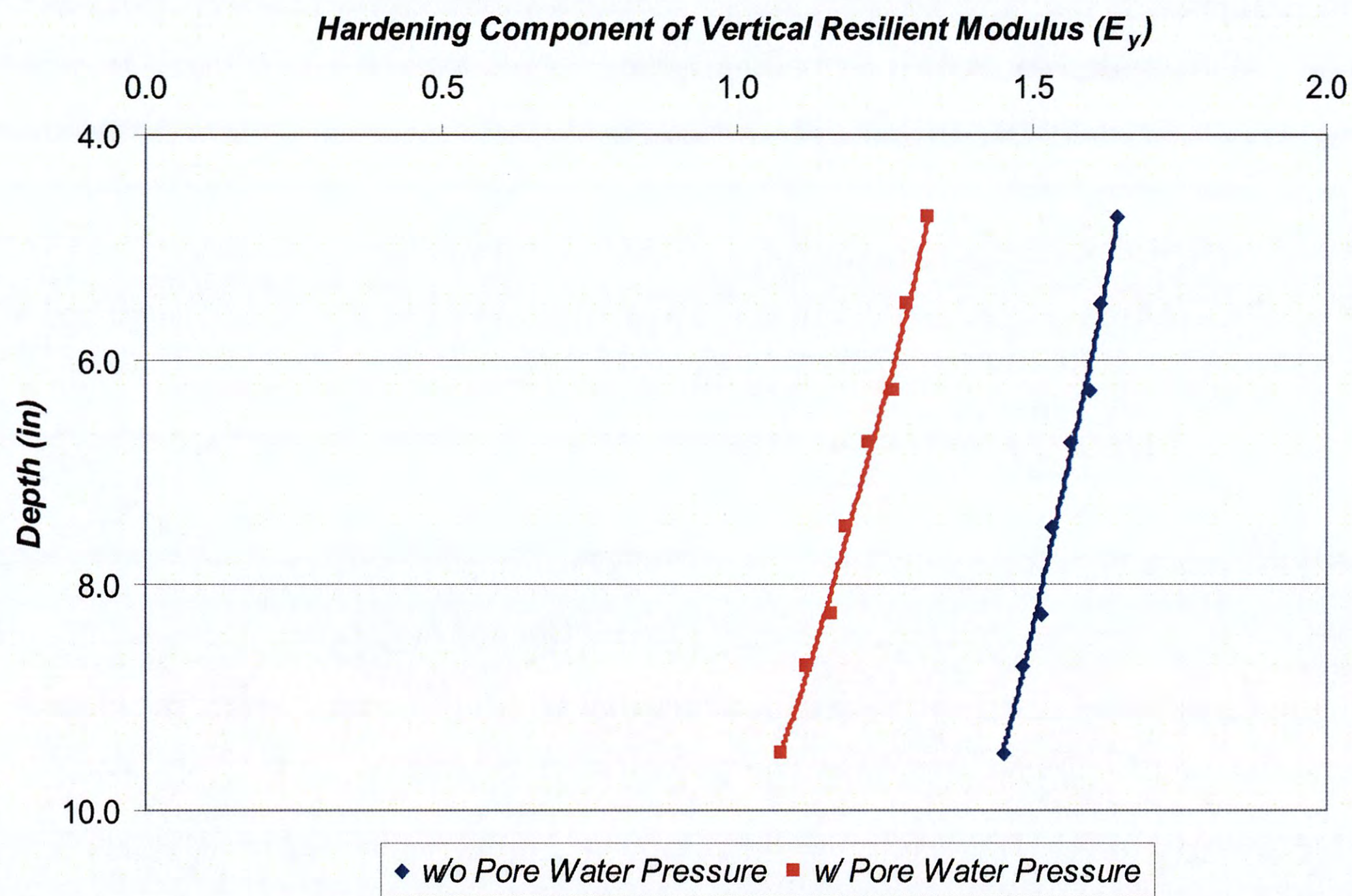

Figure B.2. Hardening Component of Vertical Modulus (Ashtiani et al. 2010).

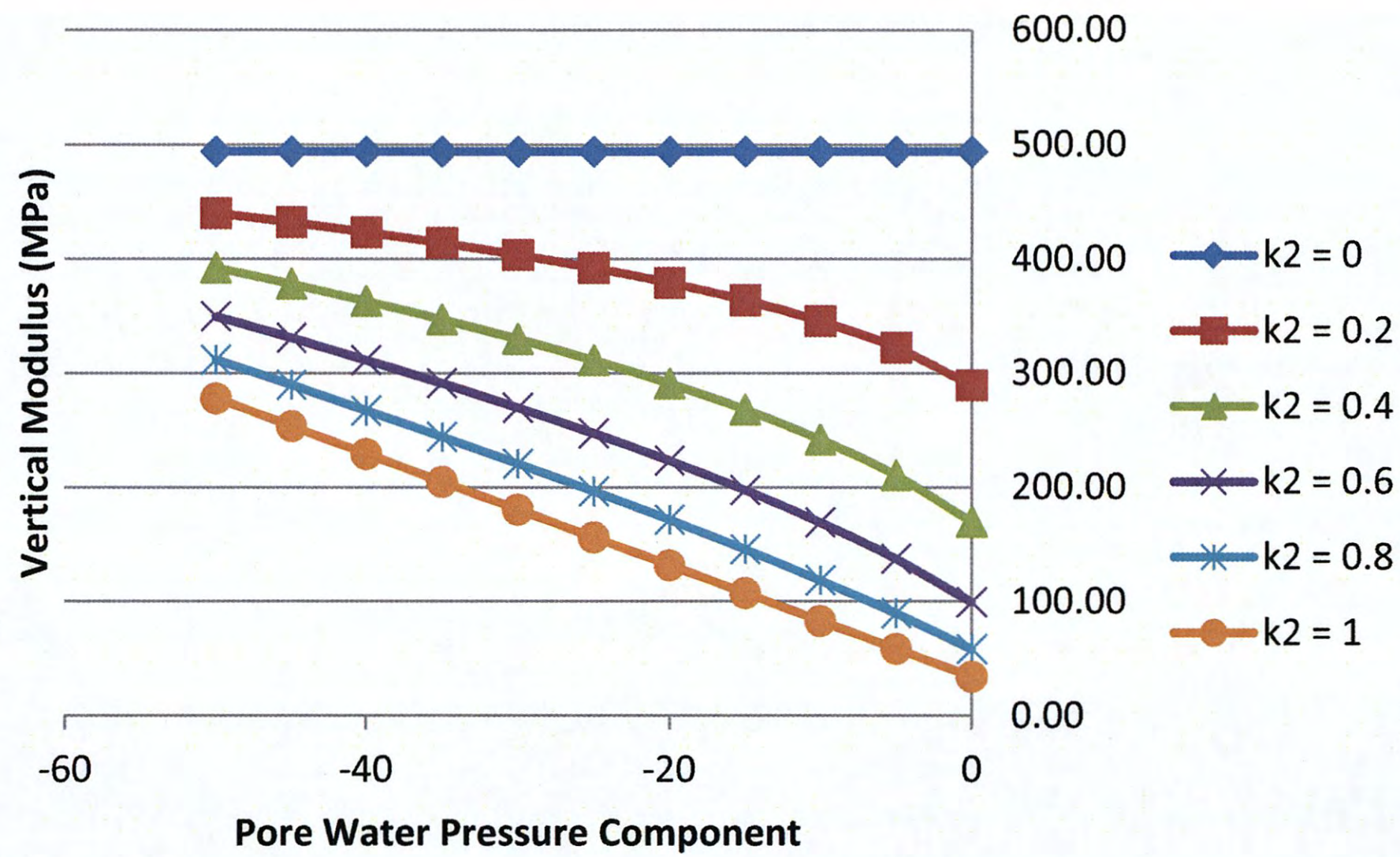

Figure B.3. Effect of Pore Water Pressure in Aggregate Base.

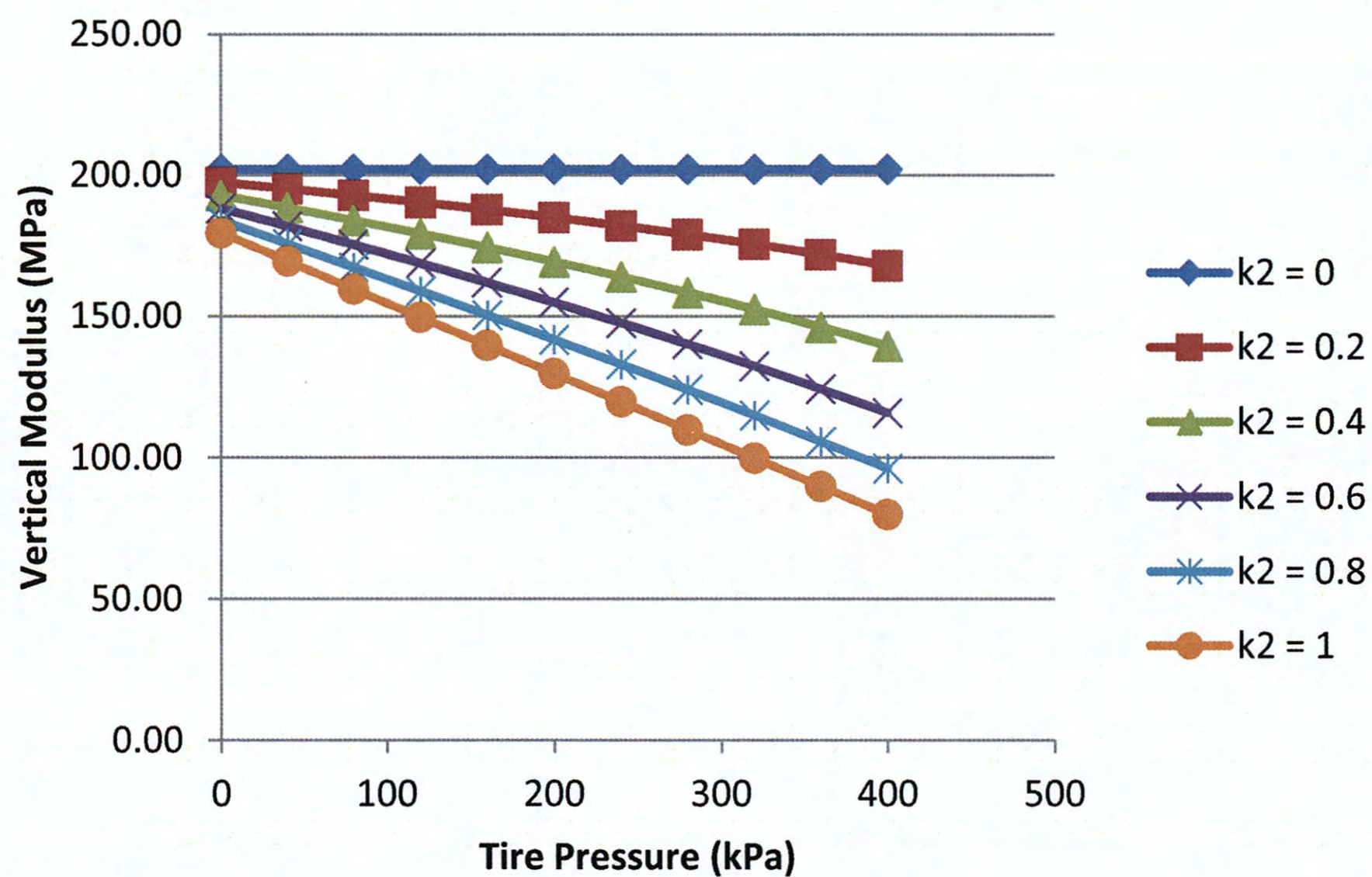

Figure B.4. Vertical Modulus of Texas Limestone Base under Different Tire Pressure.

The predicted k values of Equations 1 to 3 are summarized in Table B.6. These k values are material properties that depend on the properties of aggregate particles and aggregate matrix. Statistical analysis was performed to investigate the correlation between the k values and the aggregate properties, such as the dry density, water content, Methylene Blue Value, percent

passing the No. 200 sieve, and aggregate gradation, angularity, shape, and texture in terms of Weibull distribution parameters. Table B.7 shows the results of the statistical analysis, in which properties with a check mark prove to be statistically significant in their correlation with the k values at a 90 percent confidence level. Among all studied material properties, only aggregate texture did not show statistical correlation with the k values. Equations 4–6 show examples of the statistical models of k_1 , k_2 and k_3 :

$$\ln k_1 = -1.238 - 0.3087 \omega + 7.125 a_G \quad (4)$$

$$\ln k_2 = 32.162 - 4.762 \ln \gamma_d - 0.06724 \omega + 0.7296 \ln(MBV \cdot \%Fine) + 3.467 \ln a_G - 0.3387 \ln a_A + 2.295 \ln a_S \quad (5)$$

$$\ln k_3 = -4.686 + 0.1048 \omega + 0.1689 MBV + 0.07344 a_A + 0.4455 a_S \quad (6)$$

Table B.6. Predicted k Values of Aggregate Matrixes.

Aggregate Type	Moisture State	Gradation	k Values								
			k_1	k_2	k_3	k_4	k_5	k_6	k_7	k_8	k_9
Texas Limestone	Optimum	Coarse	199.277	4.728	0.696	3.34E-01	12.039	0.672	2.286	8.987	0.678
	Dry of Optimum	Intermediate	19.589	3.504	0.645	4.13E-05	10.701	0.686	0.002	8.135	0.660
	Optimum	Intermediate	52.396	2.639	0.637	3.36E-04	8.437	0.598	0.019	6.129	0.606
	Wet of Optimum	Intermediate	20.759	2.200	0.662	9.88E-05	6.448	0.687	0.004	4.920	0.669
	Dry of Optimum	Fine	29.035	2.371	0.575	1.05E-03	6.399	0.510	0.012	5.147	0.506
	Optimum	Fine	0.854	2.778	1.085	2.28E+00	2.340	1.515	2.643	2.135	1.302
	Wet of Optimum	Fine	22.643	3.198	0.952	1.89E-05	10.130	1.271	0.001	8.003	1.120
Texas Gravel	Optimum	Coarse	17.868	2.813	0.450	7.65E-04	7.140	0.139	0.003	6.273	0.220
	Dry of Optimum	Intermediate	40.955	2.434	0.443	1.19E+00	4.007	0.311	0.476	4.105	0.383
	Optimum	Intermediate	23.019	1.440	0.454	4.76E-04	3.916	0.140	0.004	3.304	0.256
	Dry of Optimum	Fine	3.773	2.826	0.423	2.05E-03	5.499	0.104	0.005	4.960	0.257
	Optimum	Fine	17.191	1.257	0.669	2.09E-05	3.972	0.559	0.001	3.171	0.607

Table B.6. Predicted k Values of Aggregate Matrixes (continued).

Aggregate Type	Moisture State	Gradation	k Values								
			k_1	k_2	k_3	k_4	k_5	k_6	k_7	k_8	k_9
Minnesota Gravel	Dry of Optimum	Intermediate	46.653	2.643	0.585	2.04E-04	9.016	0.472	0.004	7.160	0.493
	Optimum	Intermediate	42.378	2.335	0.585	4.82E-05	8.352	0.432	0.001	6.646	0.468
	Wet of Optimum	Intermediate	11.705	1.790	0.866	4.47E-05	5.031	0.980	0.001	4.229	0.884
	Dry of Optimum	Fine	22.502	2.398	0.525	3.27E-05	7.852	0.327	0.001	6.353	0.382
	Optimum	Fine	2.843	1.849	0.680	1.09E-05	4.590	0.740	0.000	3.638	0.653
California Granite	Dry of Optimum	Intermediate	54.743	1.968	0.588	1.24E-04	7.018	0.321	0.004	5.371	0.401
	Optimum	Intermediate	85.040	2.021	0.574	1.36E-04	8.030	0.398	0.009	5.813	0.444
	Wet of Optimum	Intermediate	30.310	2.824	0.649	5.09E-05	9.434	0.560	0.001	7.452	0.567
	Dry of Optimum	Fine	17.029	2.635	0.547	6.09E-05	7.869	0.344	0.003	6.013	0.406
	Optimum	Fine	42.624	2.269	0.703	5.73E-04	7.127	0.585	0.021	5.251	0.634
	Wet of Optimum	Fine	12.789	1.456	0.640	2.43E-05	4.358	0.525	0.001	3.405	0.553

Table B.7. Correlation between Aggregate Properties and k Values.

Aggregate Property		k Values								
		k_1	k_2	k_3	k_4	k_5	k_6	k_7	k_8	k_9
γ_d (Dry Density)			√						√	
ω (Water Content)		√	√	√			√	√		√
MBV			√	√			√			√
% Fines			√							
Gradation	a_G	√	√							
	λ_G									
Angularity	a_A		√	√						√
	λ_A									
Shape	a_S		√	√	√		√	√		√
	λ_S									
Texture	a_T									
	λ_T									

PAVEMENT PERFORMANCE ANALYSIS

The testing and modeling results detailed above were used to analyze the sensitivity of pavement performance to the material properties of unbound aggregate base. The pavement performance analysis was conducted using the pavement performance prediction models that were recently developed in TxDOT Project 0-6386 (Gharaibeh et al. 2010). The newly

developed models were calibrated using the extensive pavement condition data in TxDOT's Pavement Management Information System (PMIS). Equation 7 shows the general model form.

$$L_i = \alpha e^{-\left(\frac{A}{Age_i}\right)^\beta} \quad (7)$$

where:

L_i = density of individual distress type.

Age_i = pavement age since original construction or last maintenance or rehabilitation activity.

α = distress rating with 100 being the maximum.

β and A = model coefficients.

In the sensitivity analysis of pavement performance, every aggregate property which was proved to be statistically significant to the aggregate base moduli was varied at three levels to investigate the variation of the aggregate base moduli, which led to variations of the rate of increase of the distress density and thus to widely varying expected lives of the same pavement placed in different climatic zones in Texas. Rutting life, fatigue cracking life, and ride quality life models were developed. The following illustrates an example of rutting life analysis by varying the water content of the Texas limestone.

A Texas limestone with intermediate gradation and dry moisture state was used as the unbound aggregate base. The target water content of the aggregate base was set at 3.5 percent initially; it was increased by 10 percent to 3.85 percent and then decreased by 10 percent to 3.15 percent. The matrix suction was also changed associated with the change of water content. All other parameters remained the same, such as the matrix suction, water content, dry density, etc. Pavement Family A presented in TxDOT Project 0-6386 was chosen for the analysis. This Pavement Family includes the thick ACP (PMIS Pavement Type 4), Intermediate ACP (PMIS Pavement Type 5), and overlaid ACP (PMIS Pavement Type 9) (Gharaibeh et al. 2010). The Pavement Family was analyzed under the high traffic condition in the four climatic zones in Texas (shown in Figure B.5). Table B.8 lists the rutting model coefficients of Equation 7 for Pavement Family A with preventive maintenance under high traffic in the four climatic zones. When varying the water content by 10 percent, the vertical modulus changed significantly, which led to the change of the rate of increase of rutting as illustrated in Figures B.6 to B.9.

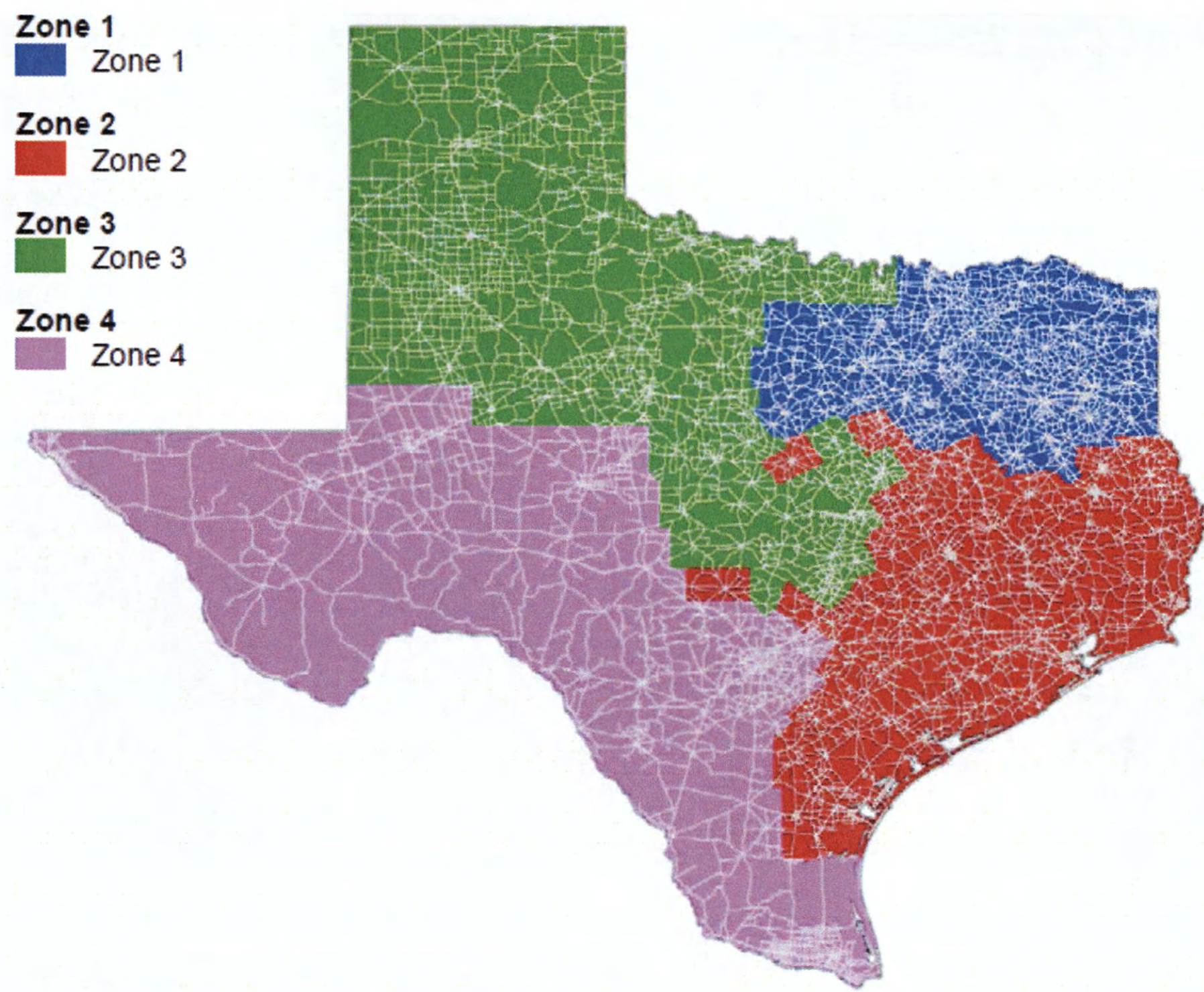

Figure B.5. Climatic Zones in Texas (Gharaibeh et al. 2010).

Table B.8. Deep Rutting Prediction Model Coefficients for Pavement Family A with Preventive Maintenance under Low Traffic.

Climatic Zone	α	β	A
I	100	0.39	58.34
II	100	0.52	71.62
III	100	0.39	93.20
IV	100	0.55	94.44

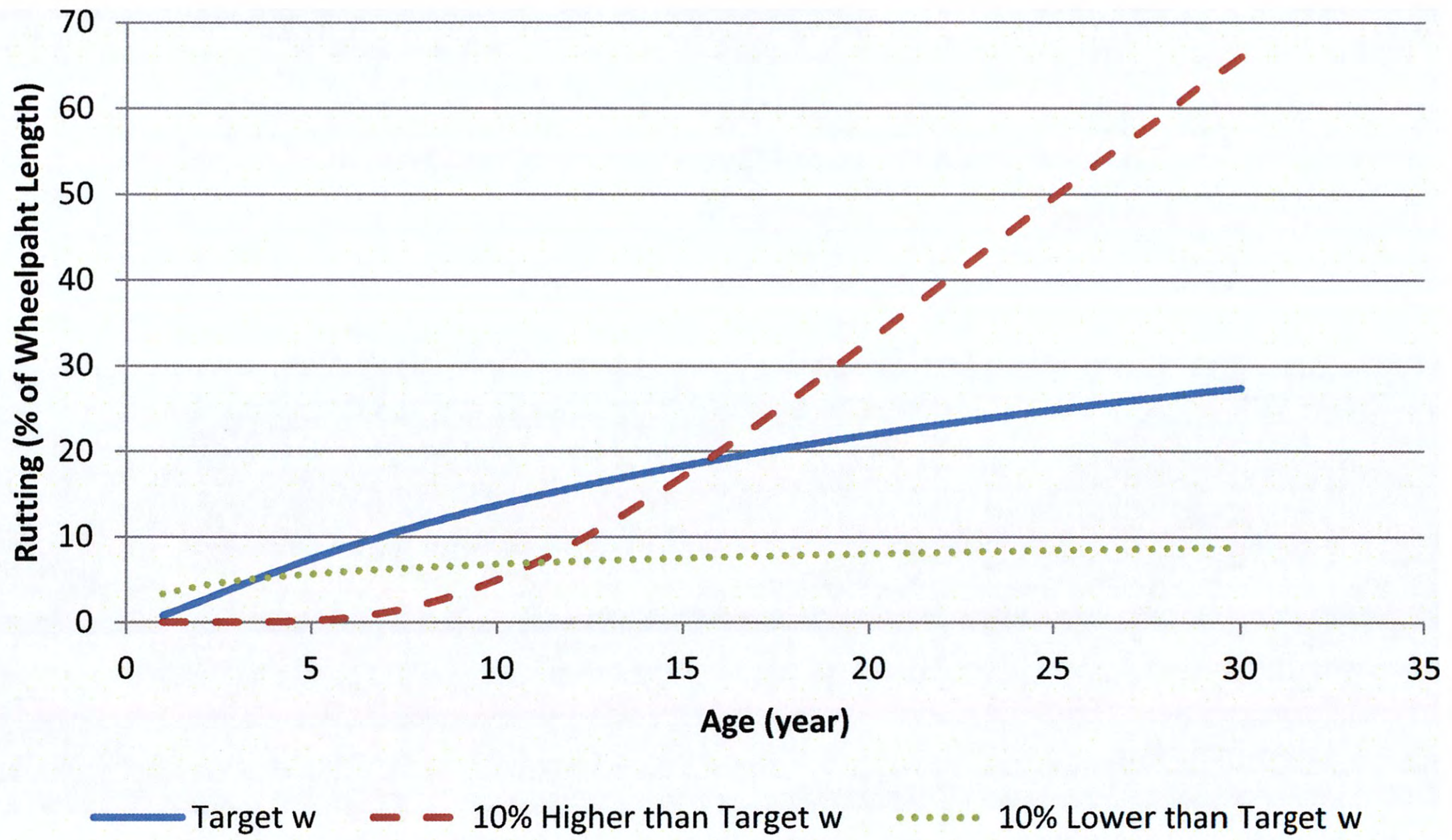

Figure B.6. Predicted Rutting Life in Climatic Zone I.

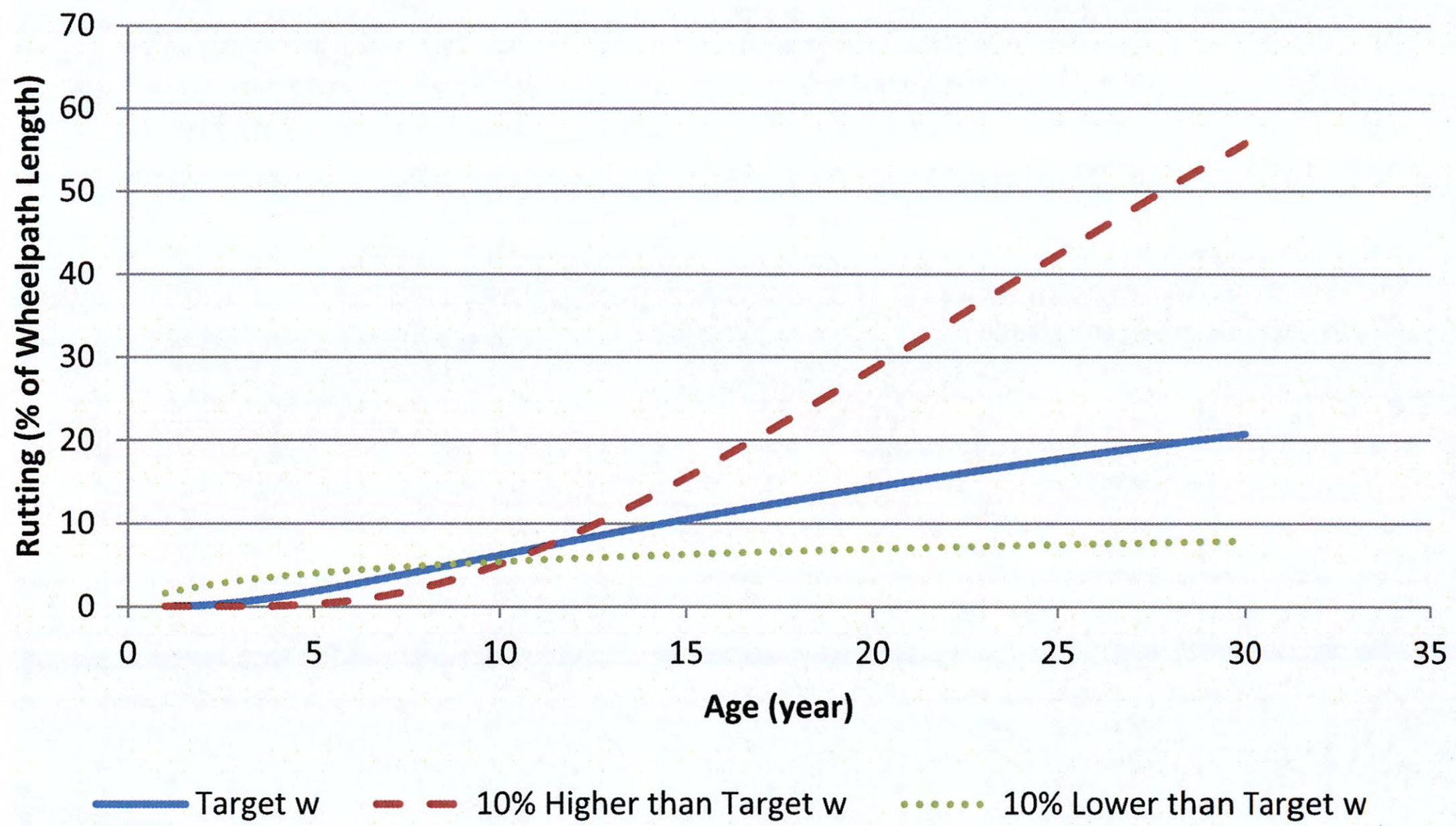

Figure B.7. Predicted Rutting Life in Climatic Zone II.

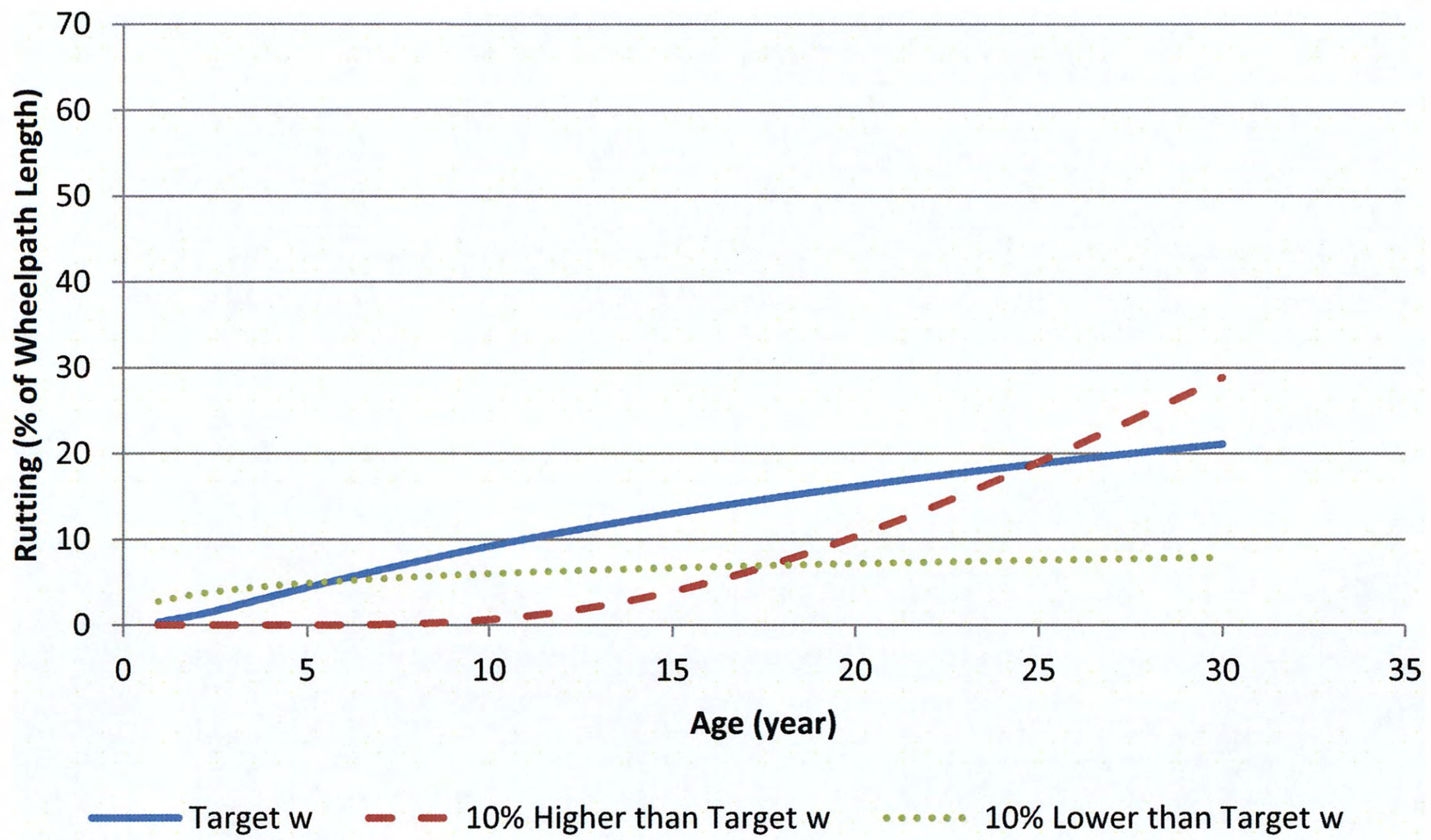

Figure B.8. Predicted Rutting Life in Climatic Zone III.

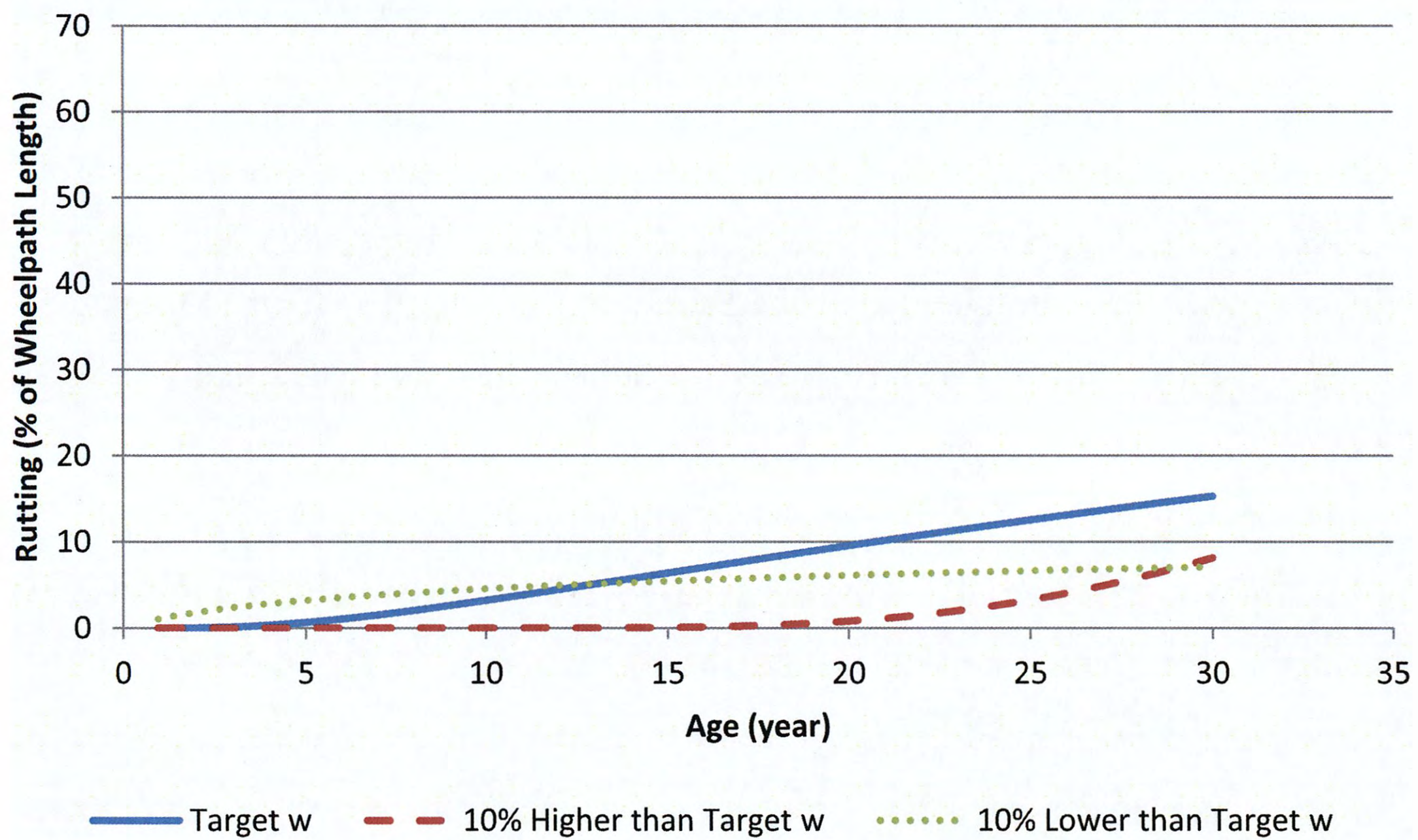

Figure B.9. Predicted Rutting Life in Climatic Zone IV.

Zone I is in northeast Texas where a variation of ± 10 percent of the water content of the Texas limestone base will have a wide range of rutting rates. The solid curve is the target base course. The dashed curve is for the same base course with 10 percent higher water content (3.85 percent). This curve demonstrates that in northeast Texas, the base course is an important component of the pavement structure, the wetter subgrade in that climatic zone providing less supporting resistance to rutting. In 15 years, this wetter base course will exhibit an increasing rate of rutting past the level expected of the target base course. As a contrast, the dotted curve representing the 10 percent drier (3.15 percent water content) base course will maintain a rutting rate that is half that of the target base course.

Zone II is in southeast Texas and along the coast of the Gulf of Mexico. The wetter base course (dashed curve) exceeds the rutting of the target base course after only 12 years. The drier base course (dotted curve) once again maintains about half of the rate of rutting as the target base course.

Zone III is in north Texas and the Panhandle. Stiffer subgrades in this drier climate allow lesser amounts of rutting with all of the base courses. The wetter base course exceeds the rutting of the target base course after about 25 years. The drier base course maintains about half the rate of rutting of the target base course.

Zone IV is in west Texas and in the Rio Grande Valley. The drier climate allows lesser amounts of rutting than in Zone I and II in eastern Texas, and even less than in Zone III. These are sensitivity analyses of the rutting model that Gharaibeh et al. (2010) developed using the base course modulus model developed at TTI for Texas limestone. These graphs in Figures B.6 through B.9 show the results of varying only the water content. In fact, the composition of the target base course and the as-compacted base course will vary in more than just the water content. For example, other sensitivity analyses have shown that the modulus of base course is very sensitive to the Methylene Blue Value and to the percent fines. The expected rate of increase of rutting and fatigue, and decrease of riding quality with age will depend on how the as-compacted base course differ from the target base course in all of these values rather than in just one as shown in Figures B.6 through B.9. What these figures demonstrate is that the Gharaibeh performance models combined with the base course modulus model are sensitive to the mixture composition of the base course and to the climatic and subgrade soils in Texas. Not shown in these figures are the effects of different types of pavement and different levels of

traffic, all of which are included in the compendium of calibrated pavement performance models that Gharaibeh et al. (2010) developed. This model combination provides an approach that will allow the observed performance of Texas pavements as recorded in the PMIS database related directly to the measurable composition and properties of the base course as they are constructed in Texas.

CONCLUSIONS

The approach presented in this appendix describes a combination of two models to provide a direct relation between observed pavement performance (Gharaibeh's models) with the observed and measurable composition and properties of a wide variety of unbound base courses. The expected performance of pavements in rutting, fatigue, and riding quality as they deteriorate with age in service can be contrasted between a target base course (the desired product) and an as-compacted base course (the provided product). The differences in expected performance between the two can be used to determine the relative value of the provided product and a rational method of adjusting pay factors. A major objective of Project 0-6621 is to develop such an approach.

REFERENCES

Ashtiani, R. S. (2009). *Anisotropic Characterization and Performance Prediction of Chemically and Hydraulically Bounded Pavement Foundations*. Ph.D. Dissertation, Texas A&M University, College Station, Texas.

Ashtiani, R. S., R. Luo, and R. L. Lytton. (2010). "Performance Prediction and Moisture Susceptibility of Anisotropic Pavement Foundations." *ASCE Geotechnical Special Publication No. 203, Paving Materials and Pavement Analysis*, American Society of Civil Engineers (ASCE), pp. 327–334.

Ashtiani, R. S., and D. N. Little (2009). *Methodology for Designing Aggregate Mixtures for Base Course*, Research Report No. ICAR/508, Texas Transportation Institute, The Texas A&M University System, College Station, Texas.

Gharaibeh, N., S. Saliminejad, A. Wimsatt, and T. Freeman (2010). *Calibration of TxDOT's Asphalt Concrete Pavement (ACP) Performance Prediction Models*, Draft Report of TxDOT Project 0-6386, Texas Transportation Institute, The Texas A&M University System, College Station, Texas.

Lytton, R. L. (1995). "Foundations and Pavements on Unsaturated Soils." Keynote Address, *Proceedings of the First International Conference on Unsaturated Soils*, International Society of Soil Mechanics and Foundation Engineering, Paris, September 8–10, pp. 1201–1220.

Park, S. W. (2000). *Evaluation of Accelerated Rut Development in Unbound Pavement Foundations and Load Limits on Load-Zoned Pavements*. Ph.D. Dissertation, Texas A&M University, College Station, Texas.

Siekmeier, J. (2011). "Implementation of Unsaturated Soil Mechanics During Pavement Construction QA." *Geo-Strata*, American Society of Civil Engineers (ASCE), Vol. 15, No. 1, pp. 36–43.

APPENDIX C.
DRAFT MIXTURE-BASED SPECIFICATION FOR FLEXIBLE BASE

Draft Specification
Draft 2.0

SPECIAL SPECIFICATION
248
FLEXIBLE BASE (QC/QA)

1.0 Description

Construct a pavement foundation course composed of a graded aggregate or flexible base.

2.0 Materials

2.1 Aggregate

2.1.1 Aggregate

Furnish uncontaminated aggregate of uniform quality to meet the Type and Grade shown on the plans and conforming to the requirements of the plans and specifications.

Notify the Engineer of all material sources. Specified base material can be from multiple sources. Notify the Engineer before changing any materials source or mixture formulation. When the contractor makes a materials source or formulation change, the Engineer will verify that the specifications requirements are met and may require a new laboratory mixture design and field trial section or both. The engineer may sample and test project materials at any time during the project to verify specification compliance.

Use Tex-100-E material definitions.

2.1.2 Material Type

Furnish the Type specified on the plans in accordance with the following:

Type A. Crushed stone produced and graded from oversize quarried aggregate that originates from a single, naturally occurring source. Do not use gravel or multiple sources.

Type B. Crushed or uncrushed gravel. Blending of two or more sources is allowed.

Type C. Crushed gravel with a minimum of 60 percent of the particles retained on a No. 4 sieve with two or more crushed faces as determined by Tex-460-A, Part I. Blending of two or more sources is allowed.

Type D. Type A material or crushed concrete. Crushed concrete containing gravel will be considered Type D material. Crushed concrete must meet the requirements in Section 2.1.4.1, “Contractor Furnished Recycled Materials” and be managed in a way to provide for uniform quality. The Engineer may require separate dedicated stockpiles in order to verify compliance.

Type E. As shown on the plans.

2.1.3 Material Grade

Furnish the Grade specified on the plans in accordance with Table C.1.

2.1.4 Recycled Materials

Crushed recycled portland cement concrete (RPCC) and reclaimed asphalt pavement (RAP) may be utilized as flexible base material. Other recycled materials may be used when shown on the plans. The percentage limitations for other than RPCC and RAP recycled materials will be as shown on the plans. Request to blend two or more sources of recycled materials. The combined blends of recycled material(s) and naturally occurring aggregate must meet the requirements of Table C.1 for the grade specified.

Recycled Concrete. Recycled portland cement concrete is salvaged, milled, pulverized, broken, or crushed portland cement concrete. The RPCC must meet the requirements of Table C.1 for the Grade specified on the plans. In addition, the RPCC must be free from reinforcing steel and other objectionable materials and meet the requirements shown in Table C.2.

The Engineer may require separate dedicated stockpiles in order to verify compliance.

Reclaimed Asphalt Pavement (RAP). Reclaimed Asphalt Pavement is salvaged, milled, pulverized, broken, or crushed asphalt bound pavement. Crush or break RAP so that 100 percent of the particles pass the 2 inch sieve. RAP must be free from objectionable materials and meet the requirements of Table C.3. When RAP is allowed, do not exceed 20 percent RAP by weight of total base course material unless otherwise shown on the plans. Test RAP without removing the asphalt binder.

The Engineer may require separate dedicated stockpiles in order to verify compliance.

2.1.4.1 Contractor Furnished Recycled Materials.

The use of Contractor-owned recycled materials is allowed unless otherwise shown on the plans. Contractor-owned surplus recycled materials remain the property of the Contractor. Remove Contractor-owned recycled materials from the project and dispose in accordance with federal, state and local regulations before the

project acceptance. Do not intermingle Contractor-owned recycled materials with Department-owned recycled materials unless approved by the Engineer.

Certify compliance of all types of recycled materials with DMS-11000, "Evaluating and Using Nonhazardous Recyclable Materials Guidelines."

Contractor furnished RCPP must meet the requirements of Table C.2. Contractor furnished RAP materials must meet the requirements of Table C.3. Other contractor furnished recycled materials (other than RCPP and RAP) must meet the requirements shown on the plans.

2.1.4.2 Department Furnished Recycled Materials.

Department-owned recycled material(s) are available to the Contractor only when shown on the plans. Return unused Department-owned recycled materials to the Department stockpile locations designated by the Engineer unless otherwise shown on the plans.

If Department-owned recycled materials are available for Contractor's use, the Contractor may use Contractor-owned recycled materials and replace the Contractor's used recycled material with an equal quantity of Department-owned recycled materials. Department-owned recycled materials generated through required work on the Contract are available for the Contractor's use when shown on the plans. When shown on the plans, the contractor will retain ownership of the recycled materials generated on the project.

Perform any necessary tests to ensure Department-owned RCPP meets the requirements of Table C.2 and RAP meets the requirements of Table C.3. Unless otherwise shown on the plans, the Department will not perform any tests or assume any liability for the quality of the Department-owned recycled materials.

The blended materials (naturally occurring aggregate and/or contractor furnished recycled material(s) and/or Department furnish recycled material(s)) must meet the requirements of Table C.1 as designed on the plans. Uniformly blend the materials to meet the requirements of Table C.1.

2.1.5 Additives

Do not use additives such as but not limited to lime, portland cement, and fly ash to modify aggregates to meet the requirements of Table C.1, unless shown on the plans.

2.2 Water

Furnish water free of industrial wastes, other objectionable matter, and with a sulfate concentration less than 3000 ppm when tested in accordance with Tex-145-E.

2.3 Prime Coat

Unless otherwise shown on the plans or approved, furnish prime materials in accordance with Item 300 "Asphalts, Oils and Emulsions."

3.0 Equipment

Provide machinery, tools and equipment necessary for proper execution of the work. Provide rollers in accordance with Item 210, "Rolling." Provide proof rollers in accordance with Item 216, "Proof Rolling," when required.

4.0 Construction

Construct each layer uniformly, free of loose or segregated areas and with the required density, moisture content, and properties as specified and/or shown on the plans. Provide a smooth surface that conforms to the typical sections, lines, and grades shown on the plans or as directed by the engineer.

The engineer may require removal and replacement or may allow the subplot or lot to be left in place with a reduced payment or without payment when the Contractor fails to comply with a specification requirement to suspend production or placement.

4.1 Certification

Personnel certified by the Department-approved Soil and Base Certification Program must conduct all mixture design, sampling and testing in accordance with Table C.4. Supply the Engineer with a list of certified personnel and copies of their current certificates before beginning production and/or placement when personnel changes are made. Provide a mixture design that is developed and signed by a Level SB 202 certified specialist. Provide a Level SB 101-certified specialist at the plant during production operations. Provide a Level SB 102-certified specialist to conduct placement tests.

The Engineer must approve the mix design based on interpretation of information supplied by certified technicians. The Engineer is not required to be certified. The Engineer is registered as a Professional Engineer in the State of Texas.

4.2 Reporting

Use Department-provided software to record and calculate all test data including but not limited to mixture design, production and placement QC/QA, control charts, and pay factors. Obtain the latest version of the software at

http://www.dot.state.tx.us/txdot_library/constultants_contractors/forms/site_manager/htm or from the Engineer. The Engineer and the Contractor shall provide any available test results to the other party when requested. The maximum allowable time for the Engineer and Contractor to exchange test data is as given in Table C.5 unless otherwise approved. The Engineer and the Contractor shall immediately report to the other party any test result that requires production to be suspended, a payment penalty or fails to meet the specification requirements. Record and submit all test results and pertinent information on Department-provided software to the Engineer electronically by means of a portable USB flash drive, compact disk, or via email.

The Engineer will use the Department-provided software to calculate all pay adjustment factors for the subplot/lot. Subplot samples may be discarded after the Engineer and Contractor sign off on the pay adjustment summary documentation for the lot.

Use the procedures described in Tex-233-F to plot the results of all quality control (QC) and quality assurance (QA) testing. Update the control charts as soon as test results for each subplot become available. Make the control charts readily accessible at the field laboratory. The Engineer may suspend production for failure to update control charts.

4.3 Quality Control Program (QCP)

Develop and follow the Quality Control Program in detail. The Engineer must approve the QCP. Obtain approval from the Engineer for changes to the QCP made during the project. The Engineer may suspend operations if the Contractor fails to comply with the QCP.

Submit a written QCP to the Engineer before the mandatory preproduction/placement meeting. If production is stopped for an extended period of time, the Engineer may require another preproduction/placement meeting prior to commencement of construction.

Receive the Engineer's approval of the QCP before beginning production and placement. Include the following items as a minimum in the QCP.

4.3.1 Project Personnel

For project personnel include:

- List of individuals responsible for Quality Control sampling and testing.
- Person responsible for mixture design.
- Person with authority to take corrective action.
- Provide copies of current certificates for all personnel.
- Provide contact information for all personnel.

4.3.2 Production

- Pit or quarry mining plan.
- Materials haul/transfer from pit/quarry to materials production facility.

- Method for “charging” materials into the production facility.
- Materials production facility process details (materials flow through the plant-screens, belts, crushers, washers, etc.).
- Stockpile location(s) from plant belts and re-established stockpiles.
- Post production blending.
- Sampling equipment and location.
- Production process control plan (contractor’s option).
- Production quality control plan (minimum requirements shown on Table C.6).

4.3.3 Material Delivery and Storage

- Location of stockpile site at quarry/pit or project.
- Vehicles used for transportation.
- Stockpiling procedures to avoid contamination and segregation.
- Stockpile quality control/quality assurance plan (minimum requirements shown on Table C6).
- Producers/contractors process control plan for stockpiling operation (contractor’s option).

4.3.4 Loading and Transportation

- Loading and transportation equipment for movement of base course materials from quarry/pit or project stockpile to placement site.
- Loading and transportation procedures to avoid contamination and segregation.

4.3.5 Placement and Compaction

- Placement and compaction equipment.
- Placement and compaction procedures to avoid contamination and segregation.
- Placement and compaction procedures to provide uniform density and moisture content.
- Contractors process control plan for placement and compaction operation (contractor’s option).
- Placement and compaction quality control/quality assurance plan (minimum requirements shown on Table C.6).

4.3.6 Finishing and Curing Operation

- Finishing equipment.
- Finishing procedure to insure conformance to lines and grades.
- Equipment for application of prime coat.
- Procedure to insure conformance to quality control for prime coat.
- Procedure to insure moisture content of base course is within limits prior to placement of surface course.

4.4 Mixture Design

4.4.1 Design Requirements

The Contractor shall use an approved laboratory to perform the base course mixture design. The Construction Division maintains a list of approved laboratories at

http://www.dot.state.tx.us/txdot_library/publications/producer_list.htm

When shown on the plans, The Engineer will provide the mixture design.

The Contractor may submit a new mixture design at anytime during the project. The Engineer will approve all mixture designs before the Contractor can begin placement of the base course.

Provide the Engineer with a mixture design report using Department-provided software. The mixture design shall meet the requirements of Table C.1. Include only those items identified in the specification in the report:

- Aggregate gradation (Tex-110-E, Part II).
- Liquid Limit, Plastic Limit and Plastic Index (Tex-104-E, Tex-105-E, Tex-106-E).
- Wet Ball Mill (Tex-116-E).
- Compressive Strength (Tex-117-E).
- Sulfate Content (Tex-145-E).
- Moisture-density relationship (Tex-113-E).
- Percent by total mass of recycled portland cement concrete (RPCC) if utilized.
- Properties of RPCC (Table C.2) gradation (Tex-110-E), deleterious materials (Tex-413-A), and sulfate content (Tex-145-E).
- Percent by total mass of reclaimed asphalt pavement (RAP) if utilized
- Properties of RAP (Table C.3), gradation (Tex-110-E), decantation (Tex-406-A), and deleterious materials (Tex-413-A).
- Signature of the Level SB 202 Certified Technician performing the mixture design.
- Date the mixture design was performed.
- Unique identification number for the mixture design.

4.4.2 Job Mix Formula Approval (JMF)

The job mix formula is the gradation, liquid limit, plastic index, wet ball mill and compressive strength as shown on Table C.1 as well as the moisture-density relationship determined by Tex-113-E. Job Mix Formula 1 (JMF 1) is determined from material stockpiled at the plant/ production site or the stockpile located at the project site. The Engineer may accept an existing mixture design previously used on a Department project and may waive the requirement for JMF 1.

“Conditional” approval for JMF 1 will be granted by the Engineer based on samples obtained from project dedicated stockpile provided the test results

meet the specification requirements. If JMF 1 submitted by the Contractor does not meet all requirements, a new JMF 1 will be submitted to the Engineer for approval according to the methodology specified herein. It is possible that several JMF 1 mixture designs will be submitted by the Contractor and evaluated by the Engineer prior to conditional approval.

A trial section (Lot 1) will be placed on the project by the Contractor using JMF 1. The Engineer will select the location for the trial section (Lot 1).

Samples of the material will be obtained from the windrow during construction of the trial section (Lot 1). The Contractor's and Engineer's test results will be used to verify JMF 1. "Final" approval of JMF 1 will be based on acceptable test results from the trial section (Lot 1).

Changes in JMF 1 may be made by the Contractor based on results from this trial section (Lot 1). If changes are made, this mixture design will be identified as JMF 2.

The Contractor will use JMF 2 to place Lot 2. Materials will be sampled and tested during the placement of Lot 2. Based on these results JMF 2 may be changed by the Contractor. This mixture design become JMF 3 and will be used on Lot 3. Additional changes in JMF's may be made during the project as described in this specification.

4.4.3 Contractor's Responsibility

4.4.3.1 Provide Mixture Design Laboratory

Provide a TxDOT approved mixture design laboratory that meets the requirements of Tex-198-E.

4.4.3.2 Provide Certified Technicians

Provide a TxDOT approved Technician(s) for conducting the mixture design in accordance with Table C.4.

4.4.3.3 Submit JMF 1

Furnish a mix design report (JMF 1) to the Engineer. JMF 1 must be submitted to the Engineer by the Contractor a minimum of 15 working days prior to placement of the trial section (Lot 1).

4.4.3.4 Supply Aggregate and Recycled Materials

Sample base course materials from the project stockpile for testing by the Engineer and Referee. Sampling will be performed according to Tex-400-A. The Engineer will witness the sampling. If blends of natural aggregate and recycled materials are proposed for use, supply sufficient quantities of these materials such that the total amount of materials supplied meets the requirements of

Tex 400-A. Supply individual materials (natural, RPCC and RAP) in their approximate proportions.

4.4.3.5 Request Conditional Approval of JMF 1

Request conditional approval of JMF 1 from the Engineer. Conditional approval by the Engineer will be based on testing for requirements in Table C.1 (gradation, Liquid Limit, Plastic Index, Wet Ball Mill, and Compressive Strength) and a moisture-density relationship. Testing will be performed on the materials supplied in Section 4.4.3.4.

4.4.3.6 Request Approval for Placement of Trial Section (Lot 1)

Request approval for placement of trial section (Lot 1) from the Engineer.

4.4.3.7 Place Trial Section (Lot 1)

The purpose of the trial section (Lot 1) is to verify that both the material and mixture properties meet the requirements in JMF 1 and the materials can be placed at the specified in-place moisture content and in-place dry density. In addition, information is provided to insure that the difference in measured parameters by both the Contractor and Engineer are within certain limits.

Upon receiving conditional approval of JMF 1 and authorization from the Engineer to place a trial section (Lot 1), place materials from the project stockpile in the trial section (Lot 1).

For placement of the trial section (Lot 1), use only equipment and materials proposed for use on the project. Use a sufficient quantity of materials during the placement of the trial section (Lot 1) to ensure that the mixture meets the specification requirements. Typically the trial section will represent a lot of material.

Provide a trial section that meets the requirements of Table C.1 and Table C.7 and with an in-place density and in-place moisture content that meets the specification as shown on Table C.9.

Note the Engineer may require that the entire Lot be removed and replaced or reworked at the Contractor's expense for failing test results.

4.4.3.8 Number of Trial Sections

Place trial sections as necessary to obtain a mixture that meets the specification requirements.

4.4.3.9 Trial Section Sampling

Obtain representative samples of the materials placed on the trial section (Lot 1) from a windrow according to Tex-400-A. Split the sample into three equal portions. Label these portions as “Contractor,” “Engineer,” and “Referee.” Deliver samples to an appropriate laboratory as directed by the Engineer.

4.4.3.10 Trial Section (Lot 1) Testing

4.4.3.10.1 Material (Production) Properties

Test materials from the trial section to ensure that the materials produced using the proposed JMF 1 meet the requirements shown on Table C.1 for the following material parameters for the Grade identified on the Plans:

- Master Gradation.
- Liquid Limit.
- Plasticity Index.
- Wet Ball Mill.
- Compressive Strength.

A laboratory compacted moisture-density relationship is also determined from samples obtained from the windrow.

For the Contractor, sampling and testing frequency requirements assume that the trial section (Lot 1) is a lot. The minimum sampling and testing for the Contractor are shown on Table C.8 and Table C.9.

The test results must be within the “Allowable Difference from Current JMF Target” as shown in Table C.7. This “difference” is relative to JMF 1 results obtained by the Contractor’s JMF submittal information. Provide a copy of the trial section test results to the Engineer.

Both the Contractor and Engineer are required to sample and test material properties. The allowable difference between Contractor and Engineer test results are shown on Table C.7 (“Allowable Difference between Contractor and Engineer Test Results”).

If the material properties do not meet the requirements of Table C.1 and Table C.7, additional sampling and testing will be performed and/or a new trial section will be placed and evaluated as directed by the Engineer.

4.4.3.10.2 In-Place (Placement) Properties

Determine in-place density and in-place moisture content of the base course in the trial section according to Tex-115-E. Use the sampling and testing frequency shown for a Lot on Table C.9. The test results from the Contractor and Engineer must meet the specification requirements shown on Table C.9 as well as the “Allowable Difference between Contractor and Engineer Test Results” shown on Table C.9.

4.4.3.11 Request Final Approval of JMF 1

The Engineer will grant final approval of JMF 1 only after all of the Engineer’s and Contractor’s test results from the Trial Section (Lot 1) are available and all meet the requirements of Table C.1, Table C.7 and Table C.9 as specified above.

4.4.3.12 Development of JMF 2

Based on the results from the trial section (Lot 1), the Contractor may develop a new JMF. This new JMF becomes JMF 2 and will be used to place Lot 2. JMF 2 must meet all the requirements of Table C.1.

4.4.3.13 Production

After receiving approval for JMF 2, proceed to Lot 2 placement. Note the Engineer may require that the entire Lot be removed and replaced or reworked at the Contractor’s expense for failing test results.

4.4.3.14 Development of JMF 3

Based on the results from the Lot 2, the Contractor may develop a new JMF. This new JMF becomes JMF 3 and will be used to place Lot 3. JMF 3 must meet all the requirements of Table C.1.

4.4.3.15 JMF Adjustments

If necessary, adjust the JMF before beginning a new lot.

- The adjusted JMF must be provided to the Engineer in writing before the start of a new lot.
- The JMF must be numbered in sequence to the previous JMF.
- The JMF must meet all other requirements shown in Table C.1.
- The JMF must be verified according to the procedures shown in Section 4.4.3.10 for the next Lot placed.

4.4.3.16 Requesting Referee Testing

If needed, use referee testing in accordance with Section 4.14.1, “Referee Testing,” to resolve testing differences with the Engineer.

4.4.4 Engineer's Responsibility

4.4.4.1 Provide Mixture Design Laboratory

Provide a TxDOT approved mixture design laboratory that meets the requirements of Tex-198-E.

4.4.4.2 Provide Certified Technicians

Provide TxDOT approved Technician(s) for conducting the mixture design in accordance with Table C.4.

4.4.4.3 Conditional Approval of JMF 1

The Engineer will evaluate JMF 1 with samples obtained from Section 4.4.3.4. Materials produced by the Contractor must meet the requirements of Table C.1.

The following tests will be conducted:

- Gradation.
- Liquid Limit.
- Plastic Index.
- Wet Ball Mill.
- Compressive Strength.
- Optimum Moisture Content.
- Maximum Dry Density.

The Engineer will consider approval of JMF 1 within 15 working days after receiving samples submitted as described in Section 4.4.3.4.

If JMF 1 submitted by the Contractor does not meet all requirements, a new JMF 1 will be submitted by the Contractor for approval according to the methodology specified herein. It is possible that several JMF 1 mixture designs will be submitted by the Contractor and evaluated by the Engineer prior to conditional approval.

The Engineer may sample and test project materials at any time during the project to verify specification compliance.

4.4.4.4 Approval for Placement of Trial Section (Lot 1)

The Engineer will consider approving the placement of the trial section within one working day of receipt of request for approval from the Contractor in accordance with Section 4.4.3.6. JMF 1 will be used to place the Trial Section (Lot 1).

4.4.4.5 Testing of Trial Section (Lot 1)

Within five working days, the engineer will sample and test materials from the trial section (Lot 1) to ensure that the material meets the requirements of Table C.1, Table C.7 and Table C.9.

The Engineer is required to perform a minimum of one test for gradation, Liquid Limit, Plastic Limit, Wet Ball Mill and Compressive Strength. These test results must meet the requirements of Table C.1, the “Allowable difference from Current JMF Target” shown on Table C.7 and “Allowable Difference between Contractor and Engineer Test Results” shown on Table C.7. When comparing the “Allowable Difference from Current JMF Target” utilize test results from JMF 1 testing in Section 4.4.4.3 of this specification. When comparing the “Allowable Difference between Contractor and Engineer Test Results” utilize test results from the Trial Section (Lot 1).

A single point on the moisture-density laboratory compaction curve will be determined according to Tex-113-F.

The single point determination for the moisture content and dry density relationship obtained by the Engineer on materials sampled from the Trial Section (Lot 1) must be within the “Allowable Difference from Current JMF Target” shown on Table C.7 and the “Allowable Difference between Contractor and Engineer Test Results” shown on Table C.7. When comparing the “Allowable Difference from Current JMF Target” utilize the test result from JMF 1 testing in Section 4.4.4.3 of this specification. When comparing the “Allowable Difference between Contractor and Engineer Test Results” utilize test results from the Trial Section (Lot 1).

The in-place moisture content and dry density for the Trial Section (Lot 1) will be determined at four (4) locations and must meet the specification requirements shown on Table C.1 and the “Allowable Difference between Contractor and Engineer Test Results” shown on Table C.9.

4.4.4.6 Final Approval of JMF 1

The Engineer will grant final approval of JMF 1 only after all of the Engineer’s and Contractor’s test results from the Trial Section (Lot 1) are available and all meet the requirements of Table C.1, Table C.7 and Table C.9 as specified above. The Engineer will notify the Contractor that an additional trial section is required if the trial section does not meet these requirements.

The Contractor may develop JMF 2 based on results from the Trial Section (Lot 1).

4.4.4.7 Conditional Approval of JMF 2 and Placement of Lot 2

The Engineer will provide conditional approval of JMF 2 within 1 working day if the submitted JMF meets the requirements shown on Table C.1. JMF 2 will be used to place Lot 2 at the Contractor's risk.

4.4.4.8 Final Approval of JMF 2

The Engineer will grant final approval of JMF 2 only after all of the Engineer's and Contractor's test results from Lot 2 are available and all meet the requirements of Table C.1, Table C.7, and Table C.9. Sections 4.4.3.10 and 4.4.4.5 of this specification will be used to determine the acceptance of JMF 2.

The Contractor is allowed to submit a JMF 3 based on results from Lot 2. JMF 3 will be evaluated using the same process as described for JMF 2 in Section 4.4.4.8 of this specification.

The Contractor may submit a new mixture design at anytime during the project. The new mixture design will be approved on the next Lot produced according to Sections 4.4.3.10 and 4.4.4.5 of this specification.

4.5 Production Operation

Prepare a new mixture design if the materials source changes, plant operation changes or the plant location changes. Take corrective action and receive approval from the Engineer to proceed with production or placement after any production or placement suspension for noncompliance to the specification.

Flexible base materials may be produced and deposited directly into a stockpile at the aggregate crushing, sizing and beneficiation production facility or blended from several stockpiles of materials from different sources including RPCC and RAP.

Materials should be stockpiled at the production facility or at the job site using procedures and process that minimize segregation.

4.6 Hauling

Clean all truck beds to ensure that the materials are not contaminated. The Contractor may elect to use belly dumps, live bottom or end dump truck to haul and transfer material.

4.7 Preparation of Subgrade, Subbase or Existing Base

Clear, scarify, shape and compact subgrade to conform to the typical sections, lines and grades shown on the plans or as directed by the Engineer. When shown on the

plans or as directed, proof-roll the roadbed in accordance with Item 216 “Proof Rolling,” before pulverizing or scarifying the subgrade. Correct soft spots as directed.

Shape and compact subbase materials to meet specifications and the lines and grades as shown on the plans.

Remove, scarify, or pulverize existing asphalt bound materials on the roadway in accordance with Item 105 “Removing Stabilized Base and Asphalt Pavement” or Item 251 “Reworking Base Courses” when shown on the plans or as directed. Shape and compact the scarified or pulverized asphalt bound materials to meet the specification and the lines and grades as shown on the plans.

When new base is required to be mixed with existing subbase, base or pulverized asphalt bound materials; place and spread the new flexible base in the required amount per station in accordance with Item 251 “Reworking Base Courses.” Thoroughly mix the new base with existing material to provide a uniform mixture to the specified depth before shaping and compacting.

4.8 Placing

Spread and shape base into a uniform layer on the grade with an approved spreader the same day as delivered unless otherwise approved. Construct layers to the thickness shown on the plans. Maintain the shape of the course. Control dust by sprinkling, as directed. Correct or replace segregated areas as directed, at no additional expense to the Department.

Place successive base courses and finish courses using the same construction methods required for the first course. When longitudinal construction joints are needed to successfully place the base course, avoid placing the joint in the lane wheel path and at the same location in successive layers. Offset longitudinal joints of successive layers six inches as a minimum.

4.9 Compaction

Compact using density control unless otherwise shown on the plans. Multiple lifts are permitted when shown on the plans or approved. The maximum compacted thickness of a lift is eight (8) inches.

Bring each layer to the moisture content shown in the mixture design. When necessary sprinkle the materials in accordance with Item 204 “Sprinkling.”

Begin rolling longitudinally at the sides and proceed toward the center, overlapping on successive trips by at least half the width of the roller unit. On super-elevated curves, begin rolling at the low side and progress toward the high side. Offset alternative trips of the roller. Operate rollers at a speed between 2 and 6 mph.

The Contractor is allowed to rework, re-compact and refinish material that fails to meet a minimum pay factor of 1.00 before the next course is placed or the project is

accepted. Continue work until the pay factor is 1.00 or above or the Engineer and Contractor accept a pay factor less than 1.00 but greater than 0.70. Materials with a pay factor of 0.70 or below must be reworked or removed. Perform the work at no additional expense to the Department.

Rework, re-compact and refinish material that fails to meet or that loses required moisture, density, stability or finish before the next course is placed or the project is accepted. Continue the work until specification requirements are met. Perform the work at no expense to the Department.

4.9.1 Ordinary Compaction

Ordinary compaction shall be used when shown on the plans.

Roll with approved compaction equipment as directed by the Engineer. Correct irregularities, depression and weak spots immediately by scarifying the areas affected, adding or removing approved material as required, reshaping and re-compacting as directed by the Engineer.

4.9.2 Density Control

Density control shall be used on all projects unless otherwise shown on the plans.

Density will be controlled as described in the "Acceptance Plan."

4.10 Finishing

After compaction is completed, clip, skin, or tight-blade the surface with a maintainer or subgrade trimmer to a depth of approximately ¼ in. Remove loosened material and dispose at an approved location. Seal the clipped surface immediately by rolling with a pneumatic tire roller until a smooth surface is attained. Add small increments of water as needed during rolling. Shape and maintain the course and surface in conformity with the typical sections, lines and grades as shown on the plans or as directed.

The flushing of the fine base course fraction to the surface by the use of water and rolling is not allowed during this finishing operation.

In areas where surfacing is to be placed, correct grade deviations greater than ¼ inch in 16 ft measured longitudinally or greater than ¼ inch over the entire width of the cross-section. Correct by loosening, adding or removing material. Reshape and re-compact the material.

4.11 Curing

Apply a prime coat when shown on the plans. Cure the finished section until the moisture content is at least two percentage points below optimum or as directed by the Engineer prior to applying the prime coat.

Apply prime coat uniformly at the rate shown on the plans or as directed by the Engineer. Use a prime coat material as shown on Section 2.3 of this specification. Apply the prime coat in a uniform manner such that streaks and other irregular patterns are avoided. Prevent splattering of prime coat when placed adjacent to curb, gutter and structures.

4.12 Acceptance Plan

Pay adjustments for the material will be in accordance with Article 6, "Payment."

Sample and test the flexible base material on a subplot and lot basis. If the production pay factor given in Section 6.5, "Production Pay Adjustment Factors," for two consecutive lots or the placement pay factor calculated according to Section 6.6, "Placement Pay Adjustment Factors," for two consecutive lots is below 1.000, suspend production until test results or other information indicate to the satisfaction of the Engineer that the next materials produced or placed will result in pay factors of a least 1.000.

4.12.1 Referee Testing

The Construction Division is the referee laboratory. The Contractor may request referee testing if a "rework," "stop production" or a "remove and replace" condition is determined based on the Engineer's test results, or if the differences between Contractor and Engineer test results exceed the maximum allowable difference shown on Table C.7 and the difference cannot be resolved. Make the request within two (2) working days after receiving test results and samples from the Engineer. Referee tests will be performed only on the subplot or lot in question and only for the particular test in question. Allow 15 working days from the time the samples are received at the referee laboratory for test results to be reported. The Department may require the Contractor to reimburse the Department for referee tests if more than three Referee tests per project are required and the Engineer's test results are closer than the Contractor's test results to the Referee test results.

Referee test results are final and will establish pay adjustment factors for the subplot or lot in question. The Contractor may decline referee testing and accept the Engineer's test results.

4.12.2 Production Acceptance

4.12.2.1 Production Lot

A production lot consists of four equal sublots. The default quantity for Lot 1 is 1000 tons; however, when requested by the Contractor, the Engineer may increase the quantity for Lot 1 to no more than 5000 tons. The Engineer will select subsequent lot sizes based on the anticipated daily production such that approximately two to four sublots are produced each day. The lot size will be

between 1000 and 5000 tons. The Engineer may change the lot size before the Contractor begins any lot.

4.12.2.1.1 Small Quantity Production

When the anticipated daily production is less than 250 tons, the total production for the project is less than 10,000 tons, when paving miscellaneous areas or when mutually agreed between the Engineer and the Contractor, the Engineer may waive all quality control and quality assurance (QC/QA) sampling and testing requirements. If the Engineer waives QC/QA sampling and testing, the production pay factors will be 1.000. However, the Engineer will retain the right to perform random acceptance tests for production and placement and may reject objectionable materials and workmanship.

When the Engineer waives all QC/QA sampling and testing requirements:

- Produce the mixture as directed by the Engineer.
- Control mixture production to meet the requirements of Table C.1.

4.12.2.1.2 Incomplete Production Lots

If a lot is begun but cannot be completed, such as on the last day of production or in other circumstances deemed appropriate, the Engineer may close the lot. Adjust the payment for the incomplete lot in accordance with Section 6.4, "Production Pay Adjustment Factors," Close all lots within five working days, unless otherwise allowed by the Engineer.

4.12.2.2 Production Sampling

The Engineer will select random numbers for all production sublots on a Lot basis according to Tex-225-F at the pre-production meeting. The Contractor will identify the sample location in the Quality Control Plan. Sampling will be performed by the Contractor and witnessed by the Engineer in accordance with Tex-400-A. The Contractor will split samples according to Tex-200-F.

Production sampling can be performed at one of eight locations:

- From belt (belt sampler or stop belt) of production plant used to form the project material stockpile.
- Stockpile of project material formed at end of production plant stockpile belt.

- Stockpile of material formed after blending two or more materials (including recycled materials).
- From the back of a haul vehicle.
- Dedicated stockpile of material at production plant site formed specifically for the project.
- Dedicated stockpile of material at project site formed specifically for the project.
- From the windrow as the material is placed on the grade.
- From the shaped grade prior to compaction.

The sampler will split each sample into three equal portions in accordance with Tex-200-F and label these portions as “Contractor,” “Engineer,” and “Referee.” The Engineer will maintain the custody of the samples labeled “Engineer” and “Referee” until tested by the Department.

4.12.2.3 Production Testing

The Contractor and Engineer must perform production quality control/quality assurance tests in accordance with Table C.6. The Contractor has the option to verify the Engineer’s test results on split samples. Determine compliance with Operational Tolerances listed in Table C.7 for all sublots and lots. The engineer may perform as many additional tests as deemed necessary.

4.12.2.4 Operational Tolerances

Production Operational Tolerances are defined on Table C.7 as the “Allowable Difference from Current JMF Target.” Control the production process within the Operational Tolerances listed in Table C.7. When production is suspended, the Engineer will allow production to resume when test results or other information indicates that the next mixture produced will be within the Operational Tolerances.

4.12.2.4.1 Gradation

A subplot is defined as out of tolerance if either the Engineer’s or the Contractor’s test results are out of Operational Tolerance as shown under “Allowable Difference from Current JMF Target” on Table C.7. Unless otherwise directed, suspend production when test results for gradation exceed the Operational Tolerances for three consecutive sublots on the same sieve or four consecutive sublots on any of the specified sieves. The consecutive sublots may be from more than one lot.

4.12.2.4.2 Liquid Limit

A lot is defined as out of tolerance if either the Engineer's or the Contractor's test results are out of Operational Tolerance as shown under "Allowable Difference from Current JMF Target" on Table C.7 or the Liquid Limit exceeds the specification requirement shown on Table C.1 for the Grade specified. Unless otherwise directed, suspend production when test results for Liquid Limit exceed the Operational Tolerances for two consecutive lots.

4.12.2.4.3 Plasticity Index

A lot is defined as out of tolerance if either the Engineer's or the Contractor's test results are out of Operational Tolerance as shown under "Allowable Difference from Current JMF Target" on Table C.7 or the Plasticity Index is outside the minimum and maximum limits shown on Table C.1 for the Grade specified. Unless otherwise directed, suspend production when test results for Plasticity Index exceed the Operational Tolerances for 2 consecutive lots for either the "minimum" or "maximum" limit or three consecutive lots for either parameter.

4.12.2.4.4 Wet Ball Mill

A lot is defined as out of tolerance if either the Engineer's or the Contractor's test results are out of Operational Tolerance as shown under "Allowable Difference from Current JMF Target" on Table C.7 or the Wet Ball Mill values exceed the maximum limits shown on Table C.1 for the Grade specified. Unless otherwise directed, suspend production when test results for Wet Ball Mill exceed the Operational Tolerances for two consecutive lots for either "percent max" or "percent passing the No. 40 sieve or three consecutive lots for either parameter.

4.12.2.4.5 Minimum Compressive Strength

A lot is defined as out of tolerance if either the Engineer's or the Contractor's test results are out of Operational Tolerance as shown under "Allowable Difference from Current JMF Target" on Table C.7 or the Compressive Strength is less than the minimum limits shown on Table C.1 for the Grade specified. Note that the Compressive Strength is not considered out of Operational Tolerance if the Compressive

Strength of the production sample exceeds the “Allowable difference from Current JMF Target” shown on Table C.7. Unless otherwise directed, suspend production when test results for the Compressive Strength does not meet the Operational Tolerances for two consecutive lots for 0 psi lateral pressure, 3 psi lateral pressure, or 15 psi lateral pressure individually or three consecutive lots for any of these parameters.

4.12.2.5 Individual Loads of Base

The Engineer can reject individual truck loads of flexible base material. When the load of flexible base material is rejected for reasons other than contamination, the Contractor may request that the rejected load be tested. Make this request within four hr of rejections. The Engineer will sample and test the mixtures. If test results are within the Operational Tolerances shown in Table C.7, payment will be made for the load. If test results are not within Operational Tolerances, no payment will be made for the load and the Engineer may require removal.

4.12.3 Placement Acceptance

4.12.3.1 Placement Lot

A placement lot consists of four placement sublots. A placement lot consists of the area placed with 1000–5000 tons of flexible base course material.

4.12.3.2 Lot 1 Placement

The Pay Adjustment Factor for Lot 1 will be 1.00. Rework or remove and replace any subplot in Lot 1 with in-place density less than 98 percent relative density.

4.12.3.3 Lot 2 and Subsequent Lots

Pay Adjustment Factors for Lot 2 and subsequent lots will be in accordance with Section 6.4 “Placement Pay Adjustment Factors.”

4.12.3.4 Incomplete Placement Lots

If a lot is begun but cannot be completed, such as on the last day of production or in other circumstances deemed appropriate, the Engineer may close the lot. Adjust the payment for the incomplete lot in accordance with Section 6.5.1, “Production Pay Adjustment Factors,” Close all lots within five working days, unless otherwise allowed by the Engineer.

Exclude “Miscellaneous Areas” as defined in Section 4.14.3.1.4 from the definition of “Incomplete Lots.”

4.12.3.5 Shoulders, Ramps, etc.

Shoulders, ramps, intersections, acceleration lanes, deceleration lanes and turn lanes are subject to in-place density determination, unless designated on the plans as not eligible for in-place density determination. Intersections and detours may be considered miscellaneous areas when determined by the Engineer.

4.12.3.6 Miscellaneous Areas

Miscellaneous areas include areas that are not generally subject to primary traffic and typically involve handwork or discontinuous placement operations, such as driveways, mailbox turnouts, crossovers, gores, spot level-up areas and other similar areas. Intersections and temporary detours may be considered miscellaneous areas when determined by the Engineer. Miscellaneous areas are not eligible for random placement sampling locations. Compact areas that are not subject to in-place density determination in accordance with Section 4.9.1, “Ordinary Compaction.”

4.12.3.7 Placement Sampling

The Engineer will select random numbers for all placement sublots and lots for quality control and quality assurance testing at the pre-placement meeting. The Engineer will provide the Contractor with the placement random numbers immediately after the subplot is completed. Mark the roadway locations at the completion of each subplot and record the station number. Determine four random sample locations for each placement subplot in accordance with Tex-225-F for in-place density and moisture content determination, one random sample location for each subplot for thickness determination, and one random location for each lot for laboratory compacted moisture density relationship determination. The one random sample location per subplot for thickness determination and the one random sample location per lot for the laboratory compacted optimum moisture content and maximum dry density determination may be identical to a random sample location selected for in-place density and moisture content determination. If the randomly generated sample location is within two ft of a joint or layer edge, adjust the location by not more than necessary to achieve a two-ft clearance.

Shoulders, ramps, intersections, detours, acceleration lanes, deceleration lanes and turn lanes are always eligible for selection as a random sample location; however, if a random sample

locations falls on one of these areas and the area is designated on the plans as not subject to in-place density determination, density measurements will not be made for the subplot and a 1.000 pay factor will be assigned to that subplot.

Immediately after determining thickness and obtaining samples to perform laboratory moisture-density determinations, repair the disturbed area with additional base course and properly compact the material.

4.12.3.8 Placement Testing

The Contractor and Engineer must perform placement quality control/quality assurance tests in accordance with Table C.9. The Contractor has the option to verify the Engineer's test results on split samples. Determine compliance with operational tolerances listed in Table C.9 for all sublots and lots. The engineer may perform as many additional tests as deemed necessary.

4.12.3.8.1 In-place Density and Moisture Content

The Contractor and Engineer will measure in-place density and moisture content in accordance with one or more methods as described in Tex-115-E. In-place moisture content will be determined at the beginning and during compaction in accordance with Tex-115-E.

4.12.3.8.2 Thickness

The Contractor and Engineer will measure the layer thickness in accordance with Tex-140-E.

4.12.3.8.3 Moisture Content and Dry Density of Laboratory Compacted Material

The Contractor and Engineer will determine a single point, laboratory compacted moisture content and dry density in accordance with Tex-113-E.

4.12.3.9 Operational Tolerances

Control the placement within the operational tolerance listed in Table C.9. When placement is suspended, the Engineer will allow production to resume when test results or other information indicates that the next materials to be placed will be within the operational tolerances.

4.12.3.9.1 In-Placed Density and Moisture Content

A subplot is defined as out of tolerance if either the Engineer's or Contractor's in-place dry density or in-place moisture content determinations are out of the

specification limits shown on Table C.9. Unless otherwise directed, suspend production when test results for in-place density or moisture content exceed the operational tolerances for two consecutive measurements for either “in-place density” or “moisture content” or three consecutive lots for either parameter.

4.12.3.9.2 Thickness

A subplot is defined as out of tolerance if either the Engineer’s or the Contractor’s test results are out of the specification limits shown on Table C.9. Unless otherwise directed, suspend placement when test results for thickness exceed the operational tolerances for two consecutive measurements.

Correct areas deficient in thickness by more than 0.5 inch by scarifying, adding material as required, reshaping, re-compacting and refinishing at the Contractor’s expense. Correct areas with excess thickness by more than 0.5 inch by scarifying, removing material as required, reshaping, re-compacting and refinishing at the Contractor’s expense.

4.12.3.9.3 Dry Density and Moisture Content of Laboratory Compacted Material

A lot is defined as out of tolerance if either the Engineer’s or the Contractor’s test results are out of operational tolerance as shown under “Allowable Difference from Current JMF Target” on Table C.9. Unless otherwise directed, suspend placement when test results exceed the operational tolerances for two consecutive lots for either “maximum dry density” or “optimum moisture content” or three consecutive lots for either parameter.

4.12.3.10 Irregularities

Identify and correct irregularities including but not limited to segregation, depressions, bumps, irregular texture, roller marks, tears, gouges, streaks, color etc. The Engineer may also identify irregularities, and in such cases, the Engineer will promptly notify the Contractor. If the Engineer determines that the irregularity will adversely affect pavement performance, the Engineer may require the Contractor to rework or remove and replace the area. If irregularities are detected, the Engineer may require the Contractor to immediately suspend operations or may allow the Contractor to

continue operations for no more than one day while the Contractor is taking appropriate corrective action.

4.12.3.11 Smoothness

Smoothness requirements are provided in Section 4.10 "Finishing." Grade deviations should not be greater than 0.25 inch in 16 ft measured longitudinal or greater than 0.25 inch over the entire width of the cross section.

5.0 Measurement

Flexible base will be measured as follows:

- Flexible Base (Complete in-place)-ton, square yard or any cubic yard method.
- Flexible Base (Roadway Delivery)-ton or cubic yard in vehicle.
- Flexible Base (Stockpile Delivery)-ton, cubic yard in vehicle, or cubic yard in stockpile.

Measurement by the cubic yard in final position and square yard is a plans quantity measurement. The quantity to be paid for is the quantity shown in the proposal unless modified by Article 9.2, "Plans Quantity Measurement." Additional measurements or calculations will be made if adjustments of quantities are required.

Measurement is further defined for payment as follows.

5.1 Cubic Yard in Vehicle

By the cubic yard in vehicles of uniform capacity at the point of delivery.

5.2 Cubic Yard in Stockpile

By cubic yard in the final stockpile position by the method of average end areas.

5.3 Cubic Yard in Final Position

By the cubic yard in the completed and accepted final position. The volume of base course is computed in place by the method of average end areas between the original subgrade or existing base surfaces and the lanes, grades and slopes of the accepted base course as shown on the plans.

5.4 Square Yard

By the square yard of surface area in the completed and accepted final position. The surface area of the base course is based on the width and length of flexible base as shown on the plans.

5.5 Ton

By the ton of dry weight in vehicles as delivered. The dry weight is determined by deducting the weight of the moisture in the material at the time of weighing from the gross weight of the material. The Engineer will determine the moisture content in the materials in accordance with Tex-103-E from samples taken at the time of weighing.

When material is measured in trucks, the weight of the material will be determined on certified scales or the Contractor must provide a set of standard platform truck scales

at a location approved by the Engineer. Scales must conform to the requirements of Item 520, "Weighing and Measuring Equipment."

6.0 Payment

The work performed and materials furnished in accordance with this Item and measured as provided under "Measurement" will be paid for at the unit price bid for the types of work shown below. No additional payment will be made for thickness or width exceeding that shown on the typical section or provided on the plans for cubic yard in the final position or square yard measurement.

Sprinkling and rolling, except proof rolling, will not be paid for directly but will be subsidiary to this Item unless otherwise shown on the plans. When proof rolling is shown on the plans or directed, it will be paid for in accordance with Item 216, "Proof Rolling."

Where subgrade is constructed under this Contract, correction of soft spots in the subgrade will be at the Contractor's expense. Where subgrade is not constructed under this project, correction of soft spots in the subgrade will be paid in accordance with pertinent Items or Article 4.2, "Changes in the Work."

6.1 Flexible Base (Complete in Place)

Payment will be made for the type and grade specified. For cubic yard measurement, "In Vehicles," "In Stockpile" or "In Final Position" will be specified. For square yard measurement, a depth will be specified. This price is full compensation for furnishing materials, temporary stockpiling, assistance provided in stockpile sampling and operation to level stockpiles for measurement, loading, hauling, delivery of materials, spreading, blading, mixing, shaping, placing, compacting, reworking, finishing, correcting locations where thickness is deficient, curing, furnishing scales and labor for weighing and measuring and equipment, labor, tools, and incidentals.

6.2 Flexible Base (Roadway Delivery)

Payment will be made for the type and grade specified. For cubic yard measurement, "In Vehicle" will be specified. The unit bid will not include processing at the roadway. This price is full compensation for furnishing materials, temporary stockpiling, assistance provided in stockpile sampling and operations to level stockpiles for measurement, loading, hauling, delivery of materials, furnishing scales and labor for weighing and measuring and equipment, labor, tools and incidentals.

6.3 Flexible Base (Stockpile Delivery)

Payment will be made for the type and grade specified. For cubic yard measurement, "In Vehicle" or "In Stockpile" will be specified. The unit price bid will not include processing at the roadway. This price is full compensation for furnishing and disposing of materials, preparing the stockpile area, temporary or permanent stockpiling, assistance provided in stockpile sampling and operations to level stockpiles for measurement, loading, hauling, delivery of materials to the stockpile, furnishing scales and labor for weighing and measuring and equipment, labor, tools, and incidentals.

6.4 Pay Adjustments

Pay adjustments for bonuses and penalties will be applied as determined in this Item. Applicable pay adjustment bonuses will only be paid for sublots and lots when the Contractor supplies the Engineer with the required documentation for production and placement QC/QA test results in accordance with Section 4.2, "Reporting."

6.5 Production Pay Adjustment Factors

The production pay adjustment factor is based on the percent passing the No. 4 and No. 200 sieves. A pay adjustment factor will be determined for each lot based on the Engineer's gradation test results. The Contractor test results must be verified by the Engineer's test results. Verification of test results for a lot is based on the "Allowable Difference" between the Contractor's and Engineer's test results being within the limits as shown on Table C.7 for the No. 4 and No. 200 sieves. The Engineer can elect to test any lot at a frequency determined by the Engineer. The minimum test frequency for the Engineer is shown on Table C.6 as one test per 12 sublots or one test per three lots. The value representing a lot production as determined by the Engineer (single value or the average of several sublots) must be within the limits shown on Table C.7 when compared to the average value of the four sublot samples that represent the same lot as determined by the Contractor.

Note: The Engineer's frequency of testing for production pay adjustment factor has not been determined. The frequency is likely to be equivalent to that shown for the Contractor on Table C.8.

The Percent Within Limits (PWL) will be determined for the No. 4 and No. 200 sieve on a Lot basis. PWL calculations will be performed according to the method contained in AASHTO R 42, pages 26 to 29 utilizing the specification limits shown on Table C.7.

The Production Pay Factor will be determined for the No. 4 and No. 200 sieve according to the following formula:

$$PF = 0.50(PWL) + 55$$

where PF=pay factor for either the No. 4 or No. 200 sieve

PWL=percent within limits for either the No. 4 or No. 200 sieve

The Composite Production Pay Factor (CPPF1) will be determined according to the following formula:

$$CPPF1 = 0.2 PF(\text{No. 4 Sieve}) + 0.8 PF(\text{No. 200 Sieve})$$

where CPPF1=Composite Production Pay Factor

PF(No. 4 Sieve)=Pay Factor for No. 4 Sieve

PF(No. 200 Sieve)=Pay Factor for No. 200 Sieve

6.5.1 Payment for Incomplete Production Lots

Production pay adjustments for incomplete lots, described under Section 4.14.2.1.2, “Incomplete Production Lots,” will be calculated using the information available for the sublots constructed. A production pay factor of 1.000 will be assigned to any lot when the random sampling plan did not result in the collection of two or more samples.

6.5.2 Production Sublots or Lots Subjected to Reworking or Removal and Replacement

If either the PWL for the No. 4 or the No. 200 sieve is below 70 percent, the Engineer may require reworking, removal and replacement or remain in place with reduced payment. Replacement material meeting the requirements of this Item will be paid for in accordance with this Article.

6.6 Placement Pay Adjustment Factors

The placement pay adjustment factor is based on the in-place density and in-place moisture content determined in accordance with Tex-115-E and thickness determination.

The pay adjustment factor for in-place density and moisture content will be determined for each lot based on the Engineer’s test results. The Contractor test results must be verified by the Engineer’s test results. Verification of test results for a subplot is based on the “Allowable Difference between the Contractor’s and Engineer’s test results being within the limits as shown on Table C.9 for in-place density and in-place moisture content. The Engineer can elect to test any lot at a frequency determined by the Engineer. The minimum test frequency for the Engineer is shown on Table C.6 as one test per subplot. The value representing a subplot production as determined by the Engineer (single value or the average of several tests per subplot) must be within the limits shown on Table C.9 when compared to the average value of the 4 samples per subplot values that represent the same subplot as the Contractor determined.

Note: The Engineer’s frequency of testing for placement pay adjustment factor has not been determined. The frequency is likely to be equivalent to that shown for the Contractor on Table C.8.

The Percent Within Limits will be determined for the in-place density and the in place moisture content on a subplot basis. PWL calculations will be performed according to the method contained in AASHTO R 42, pages 26 to 29 utilizing the specification limits shown on Table C.9.

The Placement Pay Factor will be determined for the in-place density and in-place moisture content according to the following formula:

$$PF=0.50(PWL) + 55$$

where PF=pay factor for either the in-place density or in-place moisture content
PWL=percent within limits for either the in-place density or in-place moisture content

The pay factor for thickness will be determined according to Table C.10.

The Composite Placement Pay Factor (CPPF2) will be determined according to the following formula:

$$CPPF2=0.2PF \text{ (In-Place Moisture Content)} + 0.50PF \text{ (In-Place Density)} + 0.3PF \text{ (Thickness)}$$

where CPPF2-Composite Placement Pay Factor
PF (In-Place Moisture Content)=Pay Factor for In-Place Moisture Content
PF (In-Place Density)=Pay Factor for In-Place Density
PF (Thickness)=Pay Factor for Thickness

6.6.1 Payment for Incomplete Placement Lots

Placement pay adjustments for incomplete lots, described under Section 4.14.3.1.2, "Incomplete Placement Lots," will be calculated using the information available for the sublots constructed. A placement pay factor of 1.000 will be assigned to any subplot when the random sampling plan did not result in the collection of two or more samples.

6.6.2 Placement Lots Subjected to Removal and Replacement

If either the PWL for the in-place density or in-place moisture content is below 70 percent, the Engineer may require reworking, removal and replacement or remain in-place with reduced payment. Replacement materials meeting the requirements of this Item will be paid for in accordance with this Article.

6.7 Total Adjustment Pay Calculation

Total adjustment pay (TAP) will be based on the applicable pay adjustment factor for the project for production and placement for each lot. The pay adjustments will be separate for production and placement and will not be combined.

Table C.1. Material Requirements.

Property	Test Method	Grade 1	Grade 2	Grade 3	Grade 4	Grade 5
Master gradation sieve size (cumulative % passing)						
2 ½ in.	Tex-110-E	-	0	0	As shown on the plans	100
1 ¾ in.		100	90-100	90-100		95-100
7/8 in.		65-90	-	-		65-90
3/8 in.		50-70	-	-		35-65
No. 4		35-55	25-55	25-55		25-50
No. 40		15-30	15-40	15-50		10-30
No. 200		3-12	3-12	3-12		3-12
Liquid limit, % max ¹	Tex-104-E	35	40	40	As shown on the plans	35
Plasticity index, max ¹	Tex-106-E	10	12	12	As shown on the plans	10
Plasticity index, min ¹		As Shown on Plans				
Wet ball mill, max ²	TEX-116-E	40	45	-	As shown on the plans	40
Wet ball mill, % max Increase passing the No. 40 sieve		20	20	-	As shown on the plans	20
Sulfate content, max. ppm	Tex-145-E	3000	3000	3000		3000
Min. compression strength, psi	Tex-117-E				As shown on the plans	
Lateral pressure, 0 psi		45	35	-		-
Lateral pressure, 3 psi		-	-	-		90
Lateral pressure, 15 psi		175	175	-		175

¹ Determine plasticity index in accordance with Tex-107-E (linear shrinkage) when liquid limit is unattainable as defined in Tex-104-E.

² When a soundness value is required by the plans, test material in accordance with Tex-411-A.

³ When Classification is required by other plans, a triaxial Classification of 1.0 or less for Grades 1 and 2.3 or less for Grade 2 is required. The Classification requirement for Grade 4 will be as shown on the plans.

Table C.2. Requirements for Recycled Portland Cement Concrete (RPCC).

Property	Test Method	Requirement
Gradation Cumulative Percent Passing, Maximum 2 in.	Tex-110-E	100
Deleterious Materials, Percent Maximum	Tex 413-A	1.5
Sulfate, ppm Maximum	Tex-145-E	3000

Table C.3. Requirements for Reclaimed Asphalt Pavement.

Property	Test Method	Requirement
Gradation Cumulative Percent Passing, Maximum 2 in.	Tex-110-E	100
Decantation, Percent Maximum	Tex-406-A	5.0
Deleterious Materials, Percent Maximum	TEX-413-A	1.5

Table C.4. Test Methods, Test Responsibility, and Minimum Certification Levels.

Test Description	Test Method	Contractor	Engineer	Level
1. Aggregate and Recycle Material Testing				
Sampling	Tex-400-A	x	x	SB 101
Sample Preparation	Tex-101-E	x	x	SB 101
Liquid Limit	Tex-104-E	x	x	SB 101
Plastic Limit	Tex-105-E	x	x	SB 101
Calculate Plasticity Index	Tex-106-E	x	x	SB 101
Linear Shrinkage	Tex-107-E	x	x	SB 101, 2
Sieve Analysis of Soils	Tex-110-E	x	x	SB 101
Wet Ball Mill	Tex-116-E	x	x	SB 101
Sulfate Content	Tex-145-E	x	x	SB 103
Dry Sieve	Tex-200-F, Part I	x	x	IA
Wet Sieve	Tex-200-F, Part II	x	x	IA
Decantation	Tex-406-A Tex-217-F, Part II	x	x	Not available 2
Sulfate Soundness	Tex-411-A	x	x	Not available
Deleterious Material	Tex-413-A Tex-217-F, Part I	x	x	Not available 2
Crushed Faces	Tex-460-A	x	x	2
2. Mix Design and Verification				
Moisture Content	Tex-103-E	x	x	SB 102
Moisture Content	Tex-115-E	x	x	SB 102
Moisture Density Relationships	Tex-113-E	x	x	SB 201
Triaxial Compression	Tex-117-E	x	x	SB 202

Test Description	Test Method	Contractor	Engineer	Level
3. Production Testing				
Sampling	Tex-100-E	x	x	SB 101
Sampling	Tex-400-A	x	x	SB 101
Sample Preparation	Tex-101-E	x	x	SB 101
Liquid Limit	Tex-104-E	x	x	SB 101
Plastic Limit	Tex-105-E	x	x	SB 101
Calculate Plasticity Index	Tex-106-E	x	x	SB 101
Linear Shrinkage	Tex-107-E	x	x	SB 101
Sieve Analysis of Soils	Tex-110-E	x	x	SB 101
Wet Ball Mill	Tex-116-E	x	x	SB 101
Sulfate Content	Tex-145-E	x	x	SB 103
Dry Sieve	Tex-200-F, Part I	x	x	IA
Wet Sieve	Tex-200-F, Part II	x	x	IA
Decantation	Tex-406-A Tex-217-F, Part II	x	x	Not available 2
Sulfate Soundness	Tex-411-A	x	x	Not available
Deleterious Material	Tex-413-A Tex-217-F, Part I	x	x	Not available 2
Crushed Faces	Tex-460-A	x	x	2
Moisture Content	Tex-103-E	x	x	SB 102
Moisture Content	Tex-115-E	x	x	SB 102
Moisture Density Relationship	Tex-113-E	x	x	SB 201
Selecting Random Numbers	Tex-225-F, Part I	x	x	IA
Control Charts	Tex-233-F	x	x	IA

Test Description	Test Method	Contractor	Engineer	Level
4. Placement Testing				
Moisture Content	Tex-103-E	x	x	SB 102
Moisture Density Relationship	Tex-113-E	x	x	
Field In-Place Density	Tex-115-E	x	x	SB 102
Triaxial Compression	Tex-117-E	x	x	SB 202
Depth	Tex-140-E	x	x	SB 102
Selecting Random Numbers	Tex-225-F, Part II	x	x	IA
Control Charts	Tex-233-F	x	x	IA
5. Prime Coat				
Prime Coat Sampling	Tex-500-C, Part III	x	x	IA

Table C.5. Reporting Schedule.

Description	Reported by	Reported to	To Be Reported Within
Production Quality Control	Contractor	Engineer	1 working day of completion of the subplot or lot
Gradation, liquid limit, plasticity index, wet ball mill, classification, optimum moisture content, maximum dry density			
Production Quality Assurance	Engineer	Contractor	1 working day of completion of the subplot or lot
Gradation, liquid limit, plasticity index, wet ball mill, classification, optimum moisture content, maximum dry density			
Placement Quality Control	Contractor	Engineer	1 working day of completion of the subplot or lot
Optimum moisture content, maximum dry density, in-place density, in-place moisture content, thickness			
Placement Quality Assurance	Engineer	Contractor	1 working day of completion of the subplot or lot
Optimum moisture content, maximum dry density, in-place density, in-place moisture content, thickness			
Pay Adjustment Minus No. 4, Minus No. 200, in-place moisture content, in-place density	Engineer	Contractor	2 working days of performing all required tests and receiving contractors test data

Table C.6. Minimum Sampling and Testing Requirements.

Property	Test Method	Process Control ¹	Quality Control ²	Quality Assurance ³	Pay Adjustment ⁴	
Gradation Accumulative Percent Passing						
2 ½ in.	Tex-110-E, Part II	Determined by Engineer	1 per sublot	1 per 12 sublots		
1 ¾ in.						
7/8 in.						
3/8 in.						
No. 4					4 per lot	
No. 40						
No. 200					4 per lot	
Liquid Limit, % Max ¹					Tex-104-E	1 per lot
Plastic Index, Max ¹	Tex-105-E		1 per lot	1 per 3 lots		
Plastic Index, Min ¹	Tex-106-E					
Wet Ball Mill, Max ²	TEX-116-E		Determined by Engineer	1 per lot	1 per 3 lots	
Wet Ball Mill, % Max Increase Passing the No. 40 Sieve						
Classification ³						
Min. Compression Strength ³ , psi	Tex-117-E			1 per lot	1 per 3 lots	
Lateral Pressure, 0 psi						
Lateral Pressure, 3 psi						
Lateral Pressure, 15 psi						
Optimum Moisture Content, %	Tex-113-E			1 per lot	1 per 3 lots	
Max Dry Density, lbs per cu. ft.						
In-place Density, %	Tex-115-E			4 per sublot	1 per sublot	16 per lot
In-place Moisture Content, %		16 per lot				
Thickness	Tex-140-E	1 per sublot		1 per lot		

¹ Determined by Contractor

² Performed by Contractor

³ Performed by Engineer

⁴ Use engineer-verified contractor test results

Table C.7. Allowable Material Property (Production) Differences and Specification Limits.

Property	Test Method	Allowable Difference from Current JMF Target	Allowable Difference between Contractor and Engineer Test Results	Specification Limits for Pay Factor Determination
Gradation Accumulative Percent Passing				
2 ½ in.	Tex-110-E			
1 ¾ in.		5	5	
7/8 in.		5	5	
3/8 in.		5	5	
No. 4		5	5	Plus or minus 5
No. 40		3	3	
No. 200		1.6	1.6	Plus or minus 2
Liquid Limit		Tex-104-E	5	5
Plasticity Index	Tex-105-E Tex-106-E	4	4	
Wet Ball Mill, Max	TEX-116-E	5	5	
Wet Ball Mill, % Increase Passing the No. 40 Sieve Percentage Points		4	4	
Sulfate Content, ppm	Tex-117-E	500	500	
Min. Compression Strength, psi				
Lateral Pressure, 0 psi		10	8	
Lateral Pressure, 3 psi		15	12	
Lateral Pressure, 15 psi		20	15	
Optimum Moisture Content, %	Tex-113-E	0.3	0.3	
Max Dry Density, lbs per cu. ft.		1.0	1.0	

Table C.8. Production Testing Frequency.

Property	Test Method	Minimum Contractor Testing Frequency (Quality Control)	Minimum Engineer Testing Frequency (Quality Control)
Gradation			
2 ½ in.	Tex-110-E	1 per subplot	1 per 12 sublots
1 ¾ in.			
7/8 in.			
3/8 in.			
No. 4			
No. 40			
No. 200			
Liquid Limit			
Plasticity Index	Tex-105-E Tex-106-E	1 per lot	1 per 3 lots
Wet Ball Mill	TEX-116-E	1 per lot	1 per 3 lots
Min. Compression Strength ³ , psi Lateral Pressure, 0 psi Lateral Pressure, 3 psi Lateral Pressure, 15 psi	Tex-117-E	1 per lot	1 per 3 lots
Optimum Moisture Content Maximum Dry Density	Te-113-E	1 per lot	1 per lot

Table C.9. Placement Testing Frequency, Allowable Differences, and Specification Limits.

Property	Test Method	Minimal Contractor Testing Frequency	Minimal Engineer Testing Frequency	Allowable Difference from Current JMF Target	Allowable Difference between Contractor and Engineer	Specification Limits
Optimum Moisture Content, %	Tex-113-E	1 per lot	1 per 3 lots	0.3 (percentage points)	0.3 (percentage points)	
Maximum Dry Density, lbs per cu. ft				1.0	1.0	
In-place Density, % ¹	Tex-115-E	4 per subplot	1 per subplot		2.0 (percentage points)	100
In-place Moisture Content, % ¹					0.5 (percentage points)	± 1.5
Thickness, in.	Tex-140-E	1 per subplot	1 per subplot		0.5	- 0.5 + 0.5

¹Relative to max dry density and optimum moisture content as determined according to Tex-113-E

Table C.10. Pay Adjustment Factor for Thickness.

Deviation from Thickness Shown on Plans, inches	Pay Adjustment Factor
+ 1.5	0.70
+ 1.0	0.95
+ 0.05	1.00
0.0	1.00
- 0.05	1.00
- 1.0	0.80
- 1.5	0.70

Note: Consider using Table 2 pg. 185 of Item 276, Cement Treated (Plant-mixed) Base

**Texas Transportation Institute
The Texas A&M University System
College Station, TX 77843-3135
979-845-1734
<http://tti.tamu.edu>**