



Evaluating the Impact of Overweight Load Routing on Buried Utility Facilities

Technical Report 0-6394-2

Cooperative Research Program

TEXAS TRANSPORTATION INSTITUTE
THE TEXAS A&M UNIVERSITY SYSTEM
COLLEGE STATION, TEXAS

TEXAS DEPARTMENT OF TRANSPORTATION

in cooperation with the
Federal Highway Administration and the
Texas Department of Transportation
<http://tti.tamu.edu/documents/0-6394-2.pdf>

| | | | |
|---|---|---|---------------------------------|
| 1. Report No. FHWA/TX-12/0-6394-2 | 2. Government Accession No. | 3. Recipient's Catalog No. | |
| 4. Title and Subtitle EVALUATING THE IMPACT OF OVERWEIGHT LOAD ROUTING ON BURIED UTILITY FACILITIES | | 5. Report Date October 2011 Published: December 2011 | 6. Performing Organization Code |
| | | 8. Performing Organization Report No. Report 0-6394-2 | |
| 7. Author(s) Edgar Kraus, Jeong Ho Oh, Emmanuel Fernando, Eric Yingfeng Li, Cesar Quiroga, and Nicholas Koncz | | 10. Work Unit No. (TRAIS) | |
| 9. Performing Organization Name and Address Texas Transportation Institute The Texas A&M University System College Station, Texas 77843-3135 | | 11. Contract or Grant No. Project 0-6394 | |
| | | 13. Type of Report and Period Covered Technical Report: September 2009–August 2011 | |
| 12. Sponsoring Agency Name and Address Texas Department of Transportation Research and Technology Implementation Office P.O. Box 5080 Austin, Texas 78763-5080 | | 14. Sponsoring Agency Code | |
| | | 15. Supplementary Notes Project performed in cooperation with the Texas Department of Transportation and the Federal Highway Administration. Project Title: Evaluation of Overweight Load Routing on Buried Utility Plant URL: http://ti.tamu.edu/documents/0-6394-2.pdf | |
| 16. Abstract Overweight traffic movements can negatively affect pavement integrity and quality. However, it is less known to what degree buried utility facilities along and across the right of way are affected by these overweight loads, especially if the utility facility is aged, placed under an exception to the Utility Accommodation Rules (UAR), and/or subjected to repetitive loads. Routing decisions for repetitive overweight loads may be determined without consideration of cumulative impacts to utility infrastructure, particularly municipally owned lines that could be aged, accommodated under an exception, or of substandard materials. Given the growth in volume in overweight load (particularly mid-heavy and superload) permits, the adequacy of the UAR is unknown. The objectives of this project were to (a) provide a review of technical design and engineering requirements for utility accommodation in Texas, (b) provide an assessment of potential impact of overweight loads on buried utilities, (c) provide recommendations for a business process for TxDOT overweight routing coordination, (d) provide recommendations for changes to TxDOT manuals, (e) provide an assessment of UAR adequacy to deal with overweight loads on buried utilities, and (f) provide recommendations for changes to the UAR. | | | |
| 17. Key Words Utility Accommodation Rules, UAR, Utility Accommodation, Underground Utility, Utility Damage, Pipes, Heavy Load Damage, Overweight Load | | 18. Distribution Statement No restrictions. This document is available to the public through NTIS: National Technical Information Service Alexandria, Virginia 22312 http://www.ntis.gov | |
| 19. Security Classif.(of this report) Unclassified | 20. Security Classif.(of this page) Unclassified | 21. No. of Pages 286 | 22. Price |

EVALUATING THE IMPACT OF OVERWEIGHT LOAD ROUTING ON BURIED UTILITY FACILITIES

by

Edgar Kraus, P.E.
Associate Research Engineer
Texas Transportation Institute

Jeong Ho Oh
Assistant Research Engineer
Texas Transportation Institute

Emmanuel Fernando
Senior Research Engineer
Texas Transportation Institute

Eric Yingfeng Li
Assistant Research Scientist
Texas Transportation Institute

Cesar Quiroga, P.E.
Research Engineer
Texas Transportation Institute

and

Nicholas Koncz
Assistant Research Scientist
Texas Transportation Institute

Report 0-6394-2
Project 0-6394

Project Title: Evaluation of Overweight Load Routing on Buried Utility Plant

Performed in cooperation with the
Texas Department of Transportation
and the
Federal Highway Administration

October 2011
Published: December 2011

TEXAS TRANSPORTATION INSTITUTE
The Texas A&M University System
College Station, Texas 77843-3135

DISCLAIMER

The contents of this document reflect the views of the authors, who are responsible for the facts and the accuracy of the data presented herein. The contents do not necessarily reflect the official view or policies of the Federal Highway Administration (FHWA) or the Texas Department of Transportation (TxDOT). This document does not constitute a standard, specification, or regulation, nor is it intended for construction, bidding, or permit purposes. The engineer in charge of the project was Edgar Kraus, P.E. (Texas Registration #96727).

The United States Government and the State of Texas do not endorse products or manufacturers. Trade or manufacturers' names appear herein solely because they are considered essential to the object of this report.

ACKNOWLEDGMENTS

This research was conducted in cooperation with TxDOT and FHWA. The researchers would like to acknowledge the assistance provided by many individuals at these agencies, in particular the following:

- Randy Anderson.
- John Campbell.
- Frank Espinosa.
- Raymond Hutchinson.
- Justin Obinna.
- Guy Sledge.
- Stephen Stakemiller.
- Duncan Stewart.
- Dean Wilkerson.
- Charon Williams.

The researchers also wish to acknowledge the support provided by Jerry Le with the analysis of the overweight truck routing data. The research team also acknowledges the support provided by Gerry Harrison during the testing of buried utility pipes.

TABLE OF CONTENTS

| | Page |
|--|-------------|
| LIST OF FIGURES | xi |
| LIST OF TABLES | xiv |
| LIST OF ACRONYMS, ABBREVIATIONS, AND TERMS | xvii |
| CHAPTER 1. INTRODUCTION | 1 |
| CHAPTER 2. TECHNICAL DESIGN AND ENGINEERING REQUIREMENTS FOR UTILITY ACCOMMODATION | 3 |
| INTRODUCTION | 3 |
| UNDERGROUND UTILITY STRUCTURE TYPES AND MATERIALS..... | 3 |
| Underground Utility Structure Material Standards..... | 4 |
| UNDERGROUND UTILITY STRUCTURE CONSTRUCTION STANDARDS..... | 11 |
| Embedment and Backfill..... | 11 |
| Compaction..... | 12 |
| Casings..... | 12 |
| Depth of Cover..... | 13 |
| External Loads | 13 |
| REVIEW OF EXISTING PRACTICE FOR INSTALLATION OF UNDERGROUND UTILITY STRUCTURES IN TEXAS | 26 |
| City of Grapevine Water Utility Systems | 27 |
| City of Grapevine Water Sanitary Sewer System..... | 30 |
| City of North Richland Hills..... | 33 |
| City of Fort Worth | 36 |
| City of Bedford | 38 |
| Exxon Mobile Pipeline Company | 39 |
| ATMOS Energy | 40 |
| REVIEW OF MILITARY SPECIFICATIONS FOR UNDERGROUND UTILITIES..... | 40 |
| Introduction..... | 40 |
| Water Distribution | 41 |
| Sanitary Sewers..... | 51 |
| Natural Gas/Liquid Petroleum Piping..... | 52 |
| CHAPTER 3. DESIGN REQUIREMENTS FOR UNDERGROUND UTILITY STRUCTURES IN THE TEXAS UTILITY ACCOMMODATION RULES..... | 57 |
| INTRODUCTION | 57 |
| CURRENT UTILITY ACCOMMODATION RULES | 57 |
| SUMMARY OF CHANGES TO UTILITY ACCOMMODATION RULES SINCE 1979 | 61 |
| Adopted Changes in 1982 (151) | 61 |
| Adopted Changes in 1989 (152) | 61 |
| Adopted Changes in 1990 (153) | 65 |
| Adopted Changes in 1996 (154) | 65 |

| | |
|--|-----|
| Adopted Changes in 1997 (155) | 65 |
| Adopted Changes in 1998 (156) | 65 |
| Adopted Changes in 1999 (157) | 65 |
| Adopted Changes in 2001 (158) | 65 |
| Adopted Changes in 2005 (159) | 66 |
| Adopted Changes in 2008 (160) | 67 |
| Adopted Changes in 2009 | 68 |
| RELEVANT SPECIAL PROVISIONS AT TXDOT DISTRICTS..... | 71 |
| Special Provisions for Underground Utility Facilities at the San Antonio District..... | 71 |
| Special Provisions for Underground Utility Facilities at the Bryan District | 71 |
| Special Provisions for Underground Utility Facilities at the Pharr District | 71 |
| | |
| CHAPTER 4. REVIEW OF TXDOT BUSINESS PROCESS FOR OVERWEIGHT LOAD | |
| PERMITTING | 73 |
| INTRODUCTION | 73 |
| RELEVANT OVERWEIGHT PERMIT REGULATION | 73 |
| United States Code..... | 73 |
| Code of Federal Regulations..... | 76 |
| Texas Administrative Code..... | 79 |
| TXDOT MOTOR CARRIER DIVISION | 81 |
| Overweight Permits | 81 |
| TXDOT OVERWEIGHT PERMITTING PROCESS..... | 88 |
| Staffing and Quality Control..... | 90 |
| TxPROS | 90 |
| | |
| CHAPTER 5. PHASE I UTILITY DAMAGE EVALUATION | 93 |
| INTRODUCTION | 93 |
| ANALYSIS OF OVERWEIGHT LOADS ON TXDOT HIGHWAY SYSTEM..... | 93 |
| Overview | 93 |
| Initial Data Analysis | 94 |
| Route Description Processing | 95 |
| Route Start and Route End Processing | 98 |
| Final Data Processing and Merge | 100 |
| Reconstruction of Permit Routes | 101 |
| IDENTIFICATION OF CANDIDATE CASES FOR FORENSIC ANALYSIS..... | 105 |
| Introduction..... | 105 |
| Literature Review..... | 105 |
| Outreach and Notification of Stakeholders..... | 106 |
| Proactive Approach..... | 107 |
| SENSITIVITY ANALYSIS OF DAMAGES TO BURIED UTILITY STRUCTURES..... | 110 |
| Introduction..... | 110 |
| Risk Analysis Framework..... | 110 |
| Tools for Sensitivity Analysis..... | 111 |
| Setup of Sensitivity Analysis | 112 |
| Results of the Sensitivity Analysis | 116 |
| Summary of the Sensitivity Analysis..... | 123 |
| Analysis Limitations | 124 |

| | |
|---|-----|
| CHAPTER 6. PHASE 2 UTILITY DAMAGE EVALUATION | 125 |
| INTRODUCTION | 125 |
| LABORATORY TESTING OF BURIED PIPES | 125 |
| Introduction..... | 125 |
| Testing Configuration and Setup | 126 |
| Testing Results..... | 137 |
| FINITE ELEMENT ANALYSES | 151 |
| Overview..... | 151 |
| 3D FEM Modeling of Multiple Wheel Loads..... | 153 |
| Sensitivity Analysis of Phase II | 158 |
| Results of the Sensitivity Analysis | 160 |
| CHAPTER 7. CONCLUSIONS AND RECOMMENDATIONS | 167 |
| OVERVIEW | 167 |
| SUMMARY OF TECHNICAL DESIGN AND ENGINEERING REQUIREMENTS FOR UTILITY ACCOMMODATION | 167 |
| ASSESSMENT OF POTENTIAL IMPACT OF OVERWEIGHT LOADS ON BURIED UTILITIES..... | 169 |
| RECOMMENDATIONS FOR A BUSINESS PROCESS FOR TXDOT OVERWEIGHT ROUTING COORDINATION..... | 170 |
| RECOMMENDATIONS FOR CHANGES TO TXDOT MANUALS..... | 172 |
| RECOMMENDATIONS FOR CHANGES TO THE UTILITY ACCOMMODATION RULES..... | 173 |
| Current Relevant Accommodation Rules | 173 |
| Depth of Cover Requirements | 173 |
| Encasement Requirements | 177 |
| REFERENCES | 179 |
| APPENDIX A. COMPARISON OF INSTALLATION SPECIFICATIONS FOR BURIED UTILITY FACILITIES IN THE 1979 AND 2010 UTILITY ACCOMMODATION RULES . | 195 |
| APPENDIX B. ANALYSIS OF OVERWEIGHT LOADS ON TXDOT HIGHWAY SYSTEM | 211 |
| INTRODUCTION | 211 |
| OVERWEIGHT ROUTE DATA PROCESSING | 211 |
| Initial Data Analysis | 211 |
| DATA PROCESSING AND CLEANSING..... | 221 |
| Route Description Processing | 221 |
| Route Description Processing Example..... | 224 |
| ROUTE START AND ROUTE END PROCESSING..... | 232 |
| Phase 0 | 236 |
| Phase 1 | 236 |
| Phase 2 | 237 |
| Phase 3 | 238 |
| Phase 4 | 240 |
| Phase 5 | 242 |

| | |
|---|-----|
| Phase 6 | 243 |
| FINAL DATA PROCESSING AND MERGE..... | 246 |
| Phase 7 | 247 |
| Phase 8 | 248 |
| RECONSTRUCTION OF PERMIT ROUTES | 253 |
| Preparation of Route Network | 253 |
| Junction Layer Creation..... | 256 |
| Generation of Route Shapefiles and Attribution..... | 259 |
| Post Processing of Route Shapefiles..... | 262 |
| REFERENCES | 264 |
| APPENDIX C. LETTER TO UTILITY STAKEHOLDERS..... | 265 |

LIST OF FIGURES

| | Page |
|---|------|
| Figure 1. Effect of Soil Settlement on (a) Rigid and (b) Flexible Pipes (1)..... | 4 |
| Figure 2. Rigid Pipe in Trench..... | 14 |
| Figure 3. Computational Diagram for Load Coefficient (1)..... | 15 |
| Figure 4. Positive Projecting Embankment Installation (8)..... | 16 |
| Figure 5. Load Coefficient for Positive Projection Embankment Condition (8)..... | 18 |
| Figure 6. Negative Projecting Embankment and Induced Trench Installation (8)..... | 19 |
| Figure 7. Load Coefficient for Negative Projection and Induced Trench Condition (7)..... | 20 |
| Figure 8. Stress Distributions Hypothesized by Spangler (12)..... | 22 |
| Figure 9. Outside Diameter and Thickness of Pipe..... | 31 |
| Figure 10. Trench Embedment and Backfill Details (29)..... | 32 |
| Figure 11. Storm Drain in Street (27)..... | 35 |
| Figure 12. Trench Embedment and Backfill Details..... | 36 |
| Figure 13. Definition of Single Axle and Tandem Axle Weight in the Texas Transportation Code..... | 77 |
| Figure 14. MCD Organizational Chart..... | 81 |
| Figure 15. Sample Single Trip Permit..... | 87 |
| Figure 16. Route Description Data Processing..... | 97 |
| Figure 17. Development of Is Null and Is Not Null Datasets..... | 99 |
| Figure 18. Development of JCT and Not JCT Datasets..... | 99 |
| Figure 19. Development of Origin Destination and Path Datasets..... | 100 |
| Figure 20. Final Junction Layer for GIS Route Reconstruction..... | 102 |
| Figure 21. Route Description Before and After Intersection Parsing..... | 103 |
| Figure 22. Three Steps of GIS Route Reconstruction (a: Point Shapefile Creation, b: Route Segment Creation, c: Conversion to Single Line Feature)..... | 104 |
| Figure 23. TxDOT Districts and Water Utilities TTI Contacted..... | 110 |
| Figure 24. PLAXIS Verification with Field Data from Watkins and Reeve (198)..... | 113 |
| Figure 25. PLAXIS Verification with Field Data from Arockiasamy et al. (199)..... | 114 |
| Figure 26. Varied Axle Positions with Respect to Pipe..... | 117 |
| Figure 27. Sensitivity of Damage Ratio to the Axle Position..... | 118 |
| Figure 28. Sensitivity of Damage Ratio to the Axle Weight..... | 119 |
| Figure 29. Sensitivity of Damage Ratio to Number of Axles..... | 119 |
| Figure 30. Sensitivity of Damage Ratio to the Depth of Cover..... | 120 |
| Figure 31. Sensitivity of Damage Ratio to the Pipe Material..... | 121 |
| Figure 32. Sensitivity of Damage Ratio to the Pipe Wall Thickness..... | 122 |
| Figure 33. Sensitivity of Damage Ratio to the Compaction Level..... | 123 |
| Figure 34. Dimensions of Soil Box and Direction of Test Pipe..... | 127 |
| Figure 35. Nuclear Density Gauge Test Locations..... | 128 |
| Figure 36. Cross Section of Soil Box with Soil Lifts..... | 129 |
| Figure 37. Laboratory Setup of Soil Box Test (Steps 1–6)..... | 130 |
| Figure 38. Laboratory Setup of Soil Box Test (Steps 7–12)..... | 131 |

| | |
|--|-----|
| Figure 39. Layout of Instrumented Sensors: (a) 8 Strain Gauges for Unjointed PVC Pipe; (b) 2 LVDTs for Unjointed PVC Pipe; (c) Vertical and Longitudinal LVDTs for Jointed Concrete Pipe. | 134 |
| Figure 40. Vertical Displacement Reduction along the Lateral Position..... | 136 |
| Figure 41. Parallel Plate Loading Test Setup..... | 137 |
| Figure 42. Static Test Result of Unjointed PVC Pipe..... | 138 |
| Figure 43. Variation of Displacement versus Load. | 139 |
| Figure 44. Variation of Strains versus Load. | 139 |
| Figure 45. Total Vertical and Horizontal Displacement by Number of Load Cycles (Unjointed PVC Pipe). | 140 |
| Figure 46. Total Strains versus Number of Load Cycles of Unjointed PVC Pipe. (Pipe Cross Section Shows Color Code of Strain Gauges.)..... | 141 |
| Figure 47. Visual Inspection after Fatigue Test of Unjointed PVC Pipe..... | 141 |
| Figure 48. Load-Displacement Curves of Unjointed PVC Pipes from Parallel Plate Test..... | 142 |
| Figure 49. Static Test Result of Jointed PVC Pipe. | 143 |
| Figure 50. Total Displacement versus Number of Load Cycles of Jointed PVC Pipe..... | 144 |
| Figure 51. Percentage of Vertical Pipe Diameter Reduction of Jointed PVC Pipe. | 145 |
| Figure 52. Visual Inspection of Jointed PVC Pipe after Fatigue Test. | 145 |
| Figure 53. Parallel Plate Loading Test Setup of Jointed PVC Pipe..... | 146 |
| Figure 54. Concrete Pipe Testing Setup. | 146 |
| Figure 55. Static Test Result of Jointed Concrete Pipe. | 147 |
| Figure 56. Fatigue Test Results of Jointed Concrete Pipe. | 148 |
| Figure 57. Concrete Pipe Fatigue Damage Observed..... | 148 |
| Figure 58. Longitudinal Displacement of Jointed Concrete Pipe from Fatigue Load Test. | 149 |
| Figure 59. Parallel Plate Loading Test Setup of Jointed Concrete Pipe. | 149 |
| Figure 60. Load-Displacement Curves of Jointed Concrete Pipe from Parallel Plate Test..... | 150 |
| Figure 61. Propagation of Crack of the Jointed Concrete Pipe..... | 150 |
| Figure 62. Finite-Element Meshes Used in Analysis (Cross Sectional View and 3D View.).... | 154 |
| Figure 63. Illustration of 3D Mesh Used for Five Axles (3D View and Bird’s Eye View). | 155 |
| Figure 64. 2D Mesh for a Superheavy Load of 19 Axles. | 156 |
| Figure 65. Effect of Multiple Axles on Pipe Deformation. | 157 |
| Figure 66. Predicted Vertical Pipe Diameter Reduction and Elastic Modulus over a 50-year Period. | 158 |
| Figure 67. Sensitivity of Damage Ratio to the Depth of Cover for PVC and Concrete Pipes (Using PLAXIS Analysis Software)..... | 160 |
| Figure 68. Layout of Bedding Layer Composition..... | 161 |
| Figure 69. Sensitivity of Damage Ratio to the Uniformity of Bedding Layer (Using PLAXIS Analysis Software)..... | 162 |
| Figure 70. Pipe Bedding Conditions Considered: (a) Uniform Support, (b) Support at Ends Only..... | 163 |
| Figure 71. Calculated Vertical Displacement, Condition (a) (Blue Indicates Largest Displacement). | 164 |
| Figure 72. Calculated Vertical Displacement, Condition (b) (Blue Indicates Largest Displacement). | 164 |
| Figure 73. Calculated Von Mises Stress, Condition (a) (Red Indicates Highest Stress)..... | 165 |
| Figure 74. Calculated Von Mises Stress, Condition (b) (Red Indicates Highest Stress)..... | 165 |

| | |
|---|-----|
| Figure 75. Sample Route Descriptions Starting with a Variation of “JCT.” | 217 |
| Figure 76. Unedited Text of Route Description Field. | 224 |
| Figure 77. Route Description Text Edited by Process Step 1..... | 224 |
| Figure 78. Route Description Text Edited by Process Step 2..... | 224 |
| Figure 79. Route Description Text Edited by Process Step 3..... | 225 |
| Figure 80. Route Description Text Edited by Process Step 4..... | 225 |
| Figure 81. Route Description Text Edited by Process Step 5..... | 225 |
| Figure 82. Route Description Data Processing. | 227 |
| Figure 83. Route Description with “Route Not Identifiable” Issue, Example 1..... | 227 |
| Figure 84. Route Description with “Route Not Identifiable” Issue, Example 2..... | 228 |
| Figure 85. Route Descriptions with “Missing Direction” Issue. | 228 |
| Figure 86. Route Descriptions with “Unknown Information” Issue..... | 229 |
| Figure 87. Route Descriptions with “Unknown Route” Issue. | 230 |
| Figure 88. Route Descriptions with “Multi-Spur Route” Issue. | 231 |
| Figure 89. Development of Is Null and Is Not Null Datasets. | 238 |
| Figure 90. Development of JCT and Not JCT Datasets..... | 242 |
| Figure 91. Development of Origin Destination and Path Datasets. | 250 |
| Figure 92. Query for Merging of “Distinct Duplicates,” “Route Start and End Master, No Duplicates,” and “All Processed Route Descriptions” Datasets, Access Design View..... | 251 |
| Figure 93. Example of Connectivity Issues in the Original TxDOT Roadway Network (a: Undershoot, b: Broken link, c: Overshoot)..... | 255 |
| Figure 94. Final Route Network Used for GIS Route Reconstruction. | 256 |
| Figure 95. Common Situations Resulting in Missing Intersections. | 257 |
| Figure 96. Final Junction Layer for GIS Route Reconstruction. | 259 |
| Figure 97. Route Description before and after Intersection Parsing..... | 260 |
| Figure 98. Shortest Path Selection between Two Intersections. | 261 |
| Figure 99. Three Steps of GIS Route Reconstruction (a: Point Shapefile Creation, b: Route Segment Creation, c: Conversion to Single Line Feature). | 262 |

LIST OF TABLES

| | Page |
|---|------|
| Table 1. Grades of Steel Water Pipe Used in AWWA C200 (Standard for Steel Water Pipe 6 In. and Larger) (3)..... | 5 |
| Table 2. Selected Standards for Steel Pressure Pipes in Water System (1)..... | 6 |
| Table 3. Selected Standards for Ductile Iron Pipe (5)..... | 7 |
| Table 4. Typical PVC Pipe Design Properties (1)..... | 7 |
| Table 5. Selected Standards for PVC Pipe (6)..... | 8 |
| Table 6. Mechanical Properties Range of Fiberglass Pipe (7)..... | 8 |
| Table 7. Selected Standards for Fiberglass Pipe (7)..... | 9 |
| Table 8. Range of Mechanical Properties of AC Pipe (1)..... | 9 |
| Table 9. Selected Standards for AC Pipe (1)..... | 10 |
| Table 10. Selected Standards for Clay Pipe (1)..... | 10 |
| Table 11. Selected Standards for Concrete Pipe (1)..... | 11 |
| Table 12. Design Values of Settlement Ratio (8)..... | 17 |
| Table 13. K-Value versus Bedding Angle (12)..... | 22 |
| Table 14. Values for the Soil Support Combining Factor S_C (7)..... | 25 |
| Table 15. Values for the Constrained Modulus of the Native Soil at Pipe Zone Elevation (7)..... | 25 |
| Table 16. M_{sb} Based on Soil Type and Compaction Condition (7)..... | 26 |
| Table 17. List of Companies and Cities Contacted by Researchers..... | 27 |
| Table 18. Nominal Thickness for Standard Pressure Classes of Ductile-Iron Pipe (18)..... | 28 |
| Table 19. Dimensions of AWWA C301 Pipe (20)..... | 29 |
| Table 20. Data Sheet for Blue Brute for Class 150 ^a (24)..... | 29 |
| Table 21. SDR 35 PVC Pipe Dimensions and Weights (26)..... | 30 |
| Table 22. Gradations of Gravel and Sand Materials..... | 33 |
| Table 23. Data Sheet for Blue Brute for AWWA C900 PVC Pipe (31)..... | 34 |
| Table 24. Minimum Pressure Class (37)..... | 37 |
| Table 25. City of Bedford Specifications for Pipe Dimensions..... | 39 |
| Table 26. Exxon Mobile Pipeline Specifications for Depth of Cover..... | 40 |
| Table 27. Summary of Requirements for Water Distribution Mains..... | 42 |
| Table 28. Summary of Requirements for Water Service Lines..... | 45 |
| Table 29. Summary of Installation Requirements Related to Earthwork..... | 47 |
| Table 30. Summary of Installation Requirements for Water Mains..... | 48 |
| Table 31. Summary of Installation Requirements for Water Service Lines..... | 51 |
| Table 32. Summary of Materials- and Design-Related Guidelines for Sanitary Sewers..... | 52 |
| Table 33. Summary of Requirements for Sanitary Sewers..... | 54 |
| Table 34. Numbering of Utility Accommodation Rules Before and After Revision and Reorganization of the Texas Administrative Code in 1979..... | 60 |
| Table 35. Historical Modifications to Utility Accommodation Rules after 1979..... | 62 |
| Table 36. Weight Limitations in the United States Code (166)..... | 74 |
| Table 37. Maximum Gross Weight Exemptions in the United States Code (166)..... | 75 |
| Table 38. Weight Limitations in the Texas Transportation Code (175, 176)..... | 78 |
| Table 39. Maximum Permit Weight Limits in the Texas Administrative Code (178)..... | 80 |

| | |
|---|-----|
| Table 40. Types and Authorization for Overweight Load Permits Issued by MCD (<i>174, 176, 180, 181</i>). | 82 |
| Table 41. Other Overweight Load Permits and Authorizations in the Texas Transportation Code (<i>176</i>). | 85 |
| Table 42. Action Items or Concerns Expressed by NETx Engineers (<i>182</i>). | 90 |
| Table 43. Total Overweight Load Permits..... | 94 |
| Table 44. Total Permits and Permits with Defined Routes in Route Description Field. | 95 |
| Table 45. Permits with Clean and Permits with Flagged Route Descriptions after Five-Step Data Cleansing Process..... | 96 |
| Table 46. Summary of Final Processed GIS Permit Routes. | 104 |
| Table 47. Emergency Repair Requests by Damage Type..... | 108 |
| Table 48. Utility Type of Potentially Interesting Emergency Repair Request Records. | 108 |
| Table 49. Risk Areas and Factors of Preliminary Risk Analysis Framework. | 111 |
| Table 50. Axle and Gross Weight of Three-Axle HS-Trucks (<i>201</i>)..... | 115 |
| Table 51. Variables Considered in Sensitivity Analysis..... | 115 |
| Table 52. Material Properties of Pipe. | 115 |
| Table 53. Parameters for Mohr-Coulomb Model of Backfill Material..... | 116 |
| Table 54. Measurements of Density and Moisture Content. | 132 |
| Table 55. DCP Test Results..... | 133 |
| Table 56. Properties of Pipes Tested..... | 134 |
| Table 57. Parameters for Mohr Coulomb Model..... | 155 |
| Table 58. Comparison of Vertical Displacements of Pipe..... | 156 |
| Table 59. Variables and Material Properties Used in Sensitivity Analysis. | 159 |
| Table 60. Subgrade Properties Used in Sensitivity Analysis..... | 159 |
| Table 61. 1979 UAR: Minimum Depth of Cover for Low Pressure Gas and Liquid Petroleum, Water, Sanitary Sewer, Electric, and Underground Communication Lines..... | 174 |
| Table 62. 1979 UAR: Minimum Depth of Cover for High Pressure Gas and Liquid Petroleum Lines. | 174 |
| Table 63. 2010 UAR: Minimum Depth of Cover for Low Pressure Gas and Liquid Petroleum Lines. | 175 |
| Table 64. 2010 UAR: Minimum Depth of Cover for Water, Non-Potable Water, and Sanitary Sewer Lines. | 175 |
| Table 65. 2010 UAR: Minimum Depth of Cover for Electric Lines..... | 175 |
| Table 66. 2010 UAR: Minimum Depth of Cover for Underground Communication Lines. | 176 |
| Table 67. 2010 UAR: Minimum Depth of Cover for High Pressure Gas and Liquid Petroleum Lines. | 176 |
| Table 68. General Rules for Underground Utilities..... | 197 |
| Table 69. Low Pressure Gas and Liquid Petroleum Lines..... | 200 |
| Table 70. High Pressure Gas and Liquid Petroleum Lines..... | 202 |
| Table 71. Water Lines and Non-Potable Water Control Facilities. | 204 |
| Table 72. Installation Specifications for Buried Utility Facilities – Sanitary Sewer Lines..... | 206 |
| Table 73. Underground Electric Lines..... | 207 |
| Table 74. Underground Communication Lines. | 208 |
| Table 75. Total Overweight Load Permits..... | 211 |
| Table 76. Structure of Overweight Load Route Permits Database Table..... | 212 |

| | |
|--|-----|
| Table 77. Types of Data Content for the Combination of Route Start, Route End, and Route Description, and Usefulness of the Data for Further Analysis..... | 218 |
| Table 78. Counts of Data Combinations for ROUTE_START, ROUTE_END, and ROUTE_DESC Fields (Fiscal Years 2004–2009)..... | 219 |
| Table 79. Total Permits and Permits with Defined Routes in Route Description Field. | 221 |
| Table 80. Dataset Definitions during Route Description Data Processing..... | 223 |
| Table 81. Permits with Clean and Permits with Flagged Route Descriptions after Five-Step Data Cleansing Process..... | 226 |
| Table 82. Count of Route Descriptions with “Route Not Identifiable” Issue by Year..... | 228 |
| Table 83. Count of Route Descriptions with “Missing Direction” Issue by Year..... | 229 |
| Table 84. Route Descriptions with “Unknown Information” Issue..... | 230 |
| Table 85. Count of Route Descriptions with “Unknown Route” Issue by Year..... | 231 |
| Table 86. Count of Route Descriptions with “Multi-Spur” Issue by Year..... | 232 |
| Table 87. Dataset Definitions during Route Start and Route End Data Processing..... | 235 |
| Table 88. Sample of Records with Duplicate Permit Numbers..... | 236 |
| Table 89. Duplicate Permit Records..... | 237 |
| Table 90. Permits with Route Start and Route End Entries..... | 238 |
| Table 91. Sample of “JCT” Dataset..... | 239 |
| Table 92. Permits with “JCT” Occurrence in Route Description..... | 240 |
| Table 93. Sample of Invalid Route Information in Route Description Field..... | 241 |
| Table 94. “JCT” and “Not JCT” Permits with and without Valid Route Descriptions..... | 242 |
| Table 95. Distinct Duplicate Permit Records..... | 243 |
| Table 96. Sample Spellings of Cities in the Start Route Field..... | 244 |
| Table 97. Sample Unknown Route Start Locations..... | 245 |
| Table 98. Sample Standardized Route Start Values..... | 245 |
| Table 99. Count of Records in Route Start and End Datasets..... | 246 |
| Table 100. Dataset Definitions during Final Data Processing..... | 248 |
| Table 101. Merged Datasets from Step 8..... | 249 |
| Table 102. Counts of Records for the Origin Destination and Path Datasets..... | 249 |
| Table 103. Summary of Final Processed GIS Permit Routes..... | 263 |
| Table 104. File Geodatabase Feature Classes by Fiscal Year..... | 264 |

LIST OF ACRONYMS, ABBREVIATIONS, AND TERMS

| | |
|----------|--|
| AASHTO | American Association of State Highway and Transportation Officials |
| ABS | Acrylonitrile Butadiene Styrene |
| AC | Asbestos Cement |
| AFCESA | Air Force Civil Engineer Support Agency |
| ANSI | American National Standards Institute |
| ANSYS | ANalysis SYStem Software Program |
| ASTM | American Society for Testing and Materials |
| ASME | American Society of Mechanical Engineers |
| AWWA | American Water Works Association |
| CANDE | Culvert ANalysis and DEsign |
| CST | Construction Division at TxDOT |
| CFR | Code of Federal Regulations |
| EMPCo | Exxon Mobile Pipeline Company |
| FHWA | Federal Highway Administration |
| GIS | Geographic Information System |
| HDPE | High Density Polyethylene |
| HDPVC | High Density Polyvinyl Chloride |
| HS Truck | Hypothetical Standard Truck |
| KIP | Kilo Pound (Force) or One Thousand Pounds (Force) |
| LCV | Longer Combination Vehicle |
| LLDF | Live Load Distribution Factor |
| LRFD | Load and Resistance Factor Design |
| NASA | National Aeronautics and Space Administration |
| NAVFAC | Naval Facilities Engineering Command |
| NCHRP | National Cooperative Highway Research Program |
| NETx | North and East Texas |
| NOPI | Notices Of Proposed Installation |
| NTTA | North Texas Toll Authority |
| MCD | Motor Carrier Division at TxDOT |
| MDPE | Medium Density Polyethylene |

| | |
|--------|--|
| MNT | Maintenance Division at TxDOT |
| OS/OW | Oversize/Overweight |
| PB | Polybutylene |
| PE | Polyethylene |
| PLAXIS | PLasticity AXISymmetric Software Program |
| PSI | Pounds (Force) per Square Inch |
| PSIG | Pounds (Force) per Square Inch Gauge |
| PVC | Polyvinyl Chloride |
| PVCO | Molecularly Oriented Polyvinyl Chloride |
| ROW | Right of Way Division at TxDOT |
| RPMP | Reinforced Plastic Mortar Pressure Pipe |
| RSC | Regional Support Center |
| RTRP | Reinforced Thermo-Setting Resin Pipe |
| SDHPT | State Department of Highways and Public Transportation |
| SDR | Standard Dimension Ratio |
| SQL | Structured Query Language |
| TxDOT | Texas Department of Transportation |
| TxPROS | Texas Permit Routing Optimization System |
| TAC | Texas Administrative Code |
| TTI | Texas Transportation Institute |
| TTC | Texas Transportation Code |
| UAR | Utility Accommodation Rules |
| UIR | Utility Installation Review |
| UFC | Unified Facilities Criteria |
| UFGS | Unified Facilities Guide Specifications |
| USACE | U.S. Army Corps of Engineers |
| USC | United States Code |
| VBA | Visual Basic for Applications |

CHAPTER 1. INTRODUCTION

Overweight traffic movements can negatively affect pavement integrity and quality. However, it is less known to what degree buried utility facilities along and across the right of way are affected by these overweight loads, especially if the utility facility is aged, placed under an exception to the Utility Accommodation Rules (UAR), and/or subjected to repetitive loads. Routing decisions for repetitive overweight loads may be determined without consideration of cumulative impacts to utility infrastructure, particularly municipally owned lines that could be aged, accommodated under an exception, or of substandard materials. Given the growth in volume in overweight load (particularly mid-heavy and superload) permits, the adequacy of the UAR is unknown.

The research team proposed a two-phase approach to conduct the research. The objectives of Phase 1, accomplished during the first year of the project, were to (a) provide a review of technical design and engineering requirements for utility accommodation in Texas, (b) provide a preliminary assessment of potential impact of overweight loads on buried utilities, (c) provide a preliminary assessment of UAR adequacy to deal with overweight loads on buried utilities, (d) provide preliminary recommendations for a business process for TxDOT overweight routing coordination, and (e) provide recommendations for the Phase 2 utility damage evaluation.

The objectives of Phase 2, which will be accomplished during the second year of the project, are to (a) provide an assessment of overweight load impact on buried utilities based on documented and verified cases of load-associated damage to buried utilities, (b) provide a final assessment of UAR adequacy to deal with overweight loads on buried utilities and recommendations for changes to UAR, and (c) provide a revised business process of overweight permitting to enhance TxDOT coordination.

This report summarizes the work completed for Phase 1 of the research project. The report is organized as follows:

- Chapter 1 is this introductory chapter.
- Chapter 2 discusses technical design and engineering requirements for utility accommodation, and current practice for the installation of underground utility structures in Texas.
- Chapter 3 discusses rules and regulations for the design and accommodation of underground utility structures in Texas.
- Chapter 4 provides an overview of relevant overweight permit regulations and a review of the TxDOT business process for overweight load permitting.
- Chapter 5 discusses the structure and results of the Phase 1 damage evaluation including the results of a sensitivity analysis of damages to buried utility structures, and a summary of the analysis of overweight load routing data.

- Chapter 6 discusses the structure and results of the Phase 2 damage evaluation including the results of the finite element method analysis, and provides an assessment of potential impact of overweight loads on buried utility structures.
- Chapter 7 discusses conclusions and recommendations.

CHAPTER 2. TECHNICAL DESIGN AND ENGINEERING REQUIREMENTS FOR UTILITY ACCOMMODATION

INTRODUCTION

The utility industry uses a variety of underground utility structures, such as concrete, steel, and plastic pipes; conduits; and concrete slabs. During the first year of this project, researchers reviewed the types of buried utility structures found within the TxDOT right of way and their technical specifications for withstanding dead and live loads. The researchers gathered this information through communications with relevant TxDOT personnel and the utility industry, and from online and offline information resources. Researchers used the findings from this literature review to assess the impact of overweight loads on buried utilities and provide preliminary recommendations for changes to TxDOT policies.

UNDERGROUND UTILITY STRUCTURE TYPES AND MATERIALS

Underground utility structures have supplied essential services to the public in diverse applications such as sewer lines, drain lines, water mains, gas lines, telephone and electrical conduits, culverts, oil and coal slurry lines, and heat distribution lines (1). Among underground utility systems, water systems are considered lifelines of communities. The water system is divided into two parts: the transmission lines and the distribution system (1). A sewage system is composed of a collection system and a treatment system. Storm sewage systems can be separate from the sewage system or a combination of both. If storm sewers are separate, the sanitary sewer is usually buried relatively deep to allow for the pickup of water flow from basement while the storm sewer systems are not as deep.

In general, piping materials for underground utility structures are classified as flexible or rigid. A flexible pipe can withstand at least a 2 percent deflection without regard to structural distress. Materials that do not meet this criterion are generally considered rigid (1). Figure 2 illustrates schematically the behavior of flexible and rigid pipes buried in the ground. Steel, ductile iron or cast iron, and plastic pipes are usually considered flexible. For flexible pipes, stiffness is a critical factor in resisting structural failure such as ring deflection and buckling. Concrete and clay pipes are usually categorized as rigid pipe. For such pipes, strength to resist wall stress due to the internal pressure and external loads is critical in design.

Piping systems are typically designed to perform from 50 to 100 years since government and private sectors cannot generally afford to replace pipe systems at less than 50-year intervals. The service life is not just a function of pipe material itself, but is mainly tied to the loading or environmental conditions to which the pipe system is subjected (1).

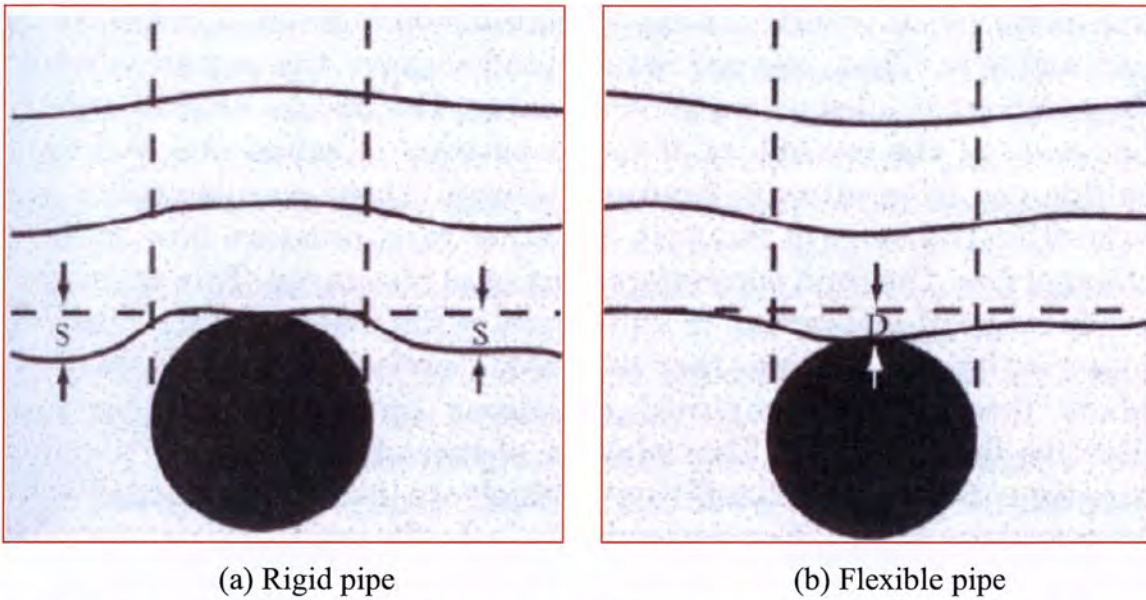

Note: S indicates settlement of backfill for a rigid pipe and D represents vertical deflection of a flexible pipe under earth pressure.

Figure 1. Effect of Soil Settlement on (a) Rigid and (b) Flexible Pipes (1).

Underground Utility Structure Material Standards

As mentioned earlier, pipe materials are generally classified as flexible or rigid. The following section summarizes different types of pipe applications and material standards.

Flexible Pipe

Steel pipe is used in many applications such as sewer, water, and culvert systems. Most steel pipes used for gravity applications have a corrugated wall. Such pipes are generally coated with bitumen type materials, Portland cement, or polymers to protect from corrosion. Note that the linings or coatings are usually ignored in strength calculations. The American Water Works Association (AWWA) manual M11 provides procedures for determining the required thickness of steel pipe (2). For this material, the existing standard uses a design stress equal to 50 percent of the specified minimum yield strength as shown in Table 1 of AWWA Manual M11. With the given pressure, the pipe wall thickness is determined using the following equation:

$$t = \frac{P_i D}{2\sigma_{\max}} \quad (1)$$

where,

- t = minimum wall thickness (in.).
- P_i = internal pressure (psi).
- D = outside diameter of steel pipe cylinder (excluding coatings, in.).
- σ_{\max} = design stress (psi).

Table 1. Grades of Steel Water Pipe Used in AWWA C200 (Standard for Steel Water Pipe 6 In. and Larger) (3).

| Pipe Specification | Design Stress (psi) | Minimum Yield Point (psi) | Minimum Ultimate Tensile Strength (psi) |
|---|----------------------------|----------------------------------|--|
| ASTM A36 | 18,000 | 36,000 | 58,000 |
| ASTM A283 GR C | 15,000 | 30,000 | 55,000 |
| GR D | 16,500 | 33,000 | 60,000 |
| ASTM A570 GR 30 | 15,000 | 30,000 | 49,000 |
| GR 33 | 16,500 | 33,000 | 52,000 |
| GR 36 | 18,000 | 36,000 | 53,000 |
| GR 40 | 20,000 | 40,000 | 55,000 |
| GR 45 | 22,500 | 45,000 | 60,000 |
| GR 50 | 25,000 | 50,000 | 65,000 |
| ASTM A572 GR 42 | 21,000 | 42,000 | 60,000 |
| GR 50 | 25,000 | 50,000 | 65,000 |
| GR 60 | 30,000 | 60,000 | 75,000 |
| ASTM A53 ASTM A135 GR A ASTM A139 | 15,000 | 30,000 | 48,000 |
| ASTM A53 ASTM A135 GR B ASTM A139 | 17,500 | 35,000 | 60,000 |
| ASTM A139 GR C | 21,000 | 42,000 | 60,000 |
| GR D | 23,000 | 46,000 | 60,000 |
| GR E | 26,000 | 52,000 | 66,000 |

Table 2 shows a list of other applicable standards for different types of steel pressure pipes in water service.

Table 2. Selected Standards for Steel Pressure Pipes in Water System (1).

| | |
|-----------|---|
| AWWA C203 | Coal-tar protective coating and linings for steel water pipelines – enamel and tape applied hot. |
| AWWA C205 | Cement-mortar protective lining and coating for steel water pipe – 4 in. and larger (shop applied). |
| AWWA C206 | Field welding of steel water pipe. |
| AWWA C207 | Steel pipe flanges for waterworks service – sizes 4 to 144 in. |
| AWWA C208 | Dimensions for fabricated steel water pipe fittings. |
| AWWA C209 | Cold-applied tape coatings for special sections, connections, and fittings for steel water pipelines. |
| AWWA C210 | Coal-tar epoxy coating system for the interior and exterior of steel water pipe. |
| AWWA C213 | Fusion-bonded epoxy coating for the interior and exterior of steel water pipelines. |
| AWWA C214 | Tape coating systems for the exterior of steel water pipelines. |
| AWWA C602 | Cement-mortar lining of water pipelines in place – 4 in. and larger. |

Ductile iron pipe is very popular in public works with respect to repair and maintenance of waste water systems (1). Ductile iron pipe usually is coated with a cement-mortar lining to improve the hydraulic efficiency and provide some corrosion protection. Most ductile iron gravity sewer systems are designed to serve a minimum of 50 years without failure or infiltration/exfiltration in excess of 10 gallons per day per inch diameter per mile (4). The most common grade of iron is 70-50-05, with acceptance values as follows (5):

- Tensile strength: 70,000 psi.
- Yield strength: 50,000 psi.
- Elongation: 5 percent.

Another permissible grade is 60-42-10, with acceptance values as given in below:

- Tensile strength: 60,000 psi.
- Yield strength: 42,000 psi.
- Elongation: 10 percent.

Table 3 summarizes available standards for ductile iron pipe.

Table 3. Selected Standards for Ductile Iron Pipe (5).

| | |
|-----------|---|
| AWWA C104 | Cement mortar lining for ductile iron. |
| AWWA C105 | Polyethylene encasement for ductile iron. |
| AWWA C110 | Ductile iron and gray iron fittings. |
| AWWA C111 | Rubber-gasket joints for ductile iron. |
| AWWA C115 | Flanged ductile iron. |
| AWWA C116 | Protective fusion-bonded epoxy coatings. |
| AWWA C150 | Thickness design of ductile iron pipe. |
| AWWA C151 | Ductile iron pipe in metal- and sand-lined molds. |
| AWWA C153 | Ductile iron compact fittings for water service. |
| AWWA C600 | Installation of ductile iron water mains and their appurtenances. |
| ASTM E8 | Materials' properties test. |
| ASTM A539 | Physical properties. |
| ASTM A746 | Ductile iron gravity sewer pipe. |

Thermoplastic pipes are also widely used in various water systems. There are four principal materials used: polyvinyl chloride (PVC), acrylonitrile-butadiene-styrene (ABS), polyethylene (PE), high-density polyethylene (HDPE), and polybutylene (PB) (1). Most plastic pressure or sewer pipes are made of PVC. The main advantage of PVC pipe is its high strength-to-weight ratio and resistance to almost all types of corrosion from chemical and electrochemical processes. Thus, any type of lining or coating is not required for PVC pipe (6). However, the performance of PVC pipe is significantly affected by its operating temperature. Table 4 and Table 5 present typical PVC pipe design properties and available standards.

Table 4. Typical PVC Pipe Design Properties (1).

| | |
|--|------------------------|
| Hydrostatic design basis | 4000 psi |
| Hydrostatic design stress | 1600 to 2000 psi |
| Elastic modulus (pressure formulation) | 400,000 psi |
| Elastic modulus (sewer formulation) | 400,000 to 550,000 psi |
| Tensile stress | 7000 psi |

Table 5. Selected Standards for PVC Pipe (6).

| | |
|------------|---|
| AWWA C605 | Underground installation of PVC. |
| AWWA C900 | PVC pressure pipe, 4 to 12 in. for water system. |
| AWWA C950 | PVC water transmission pipe 14 to 36 in. |
| ASTM D2672 | Bell-end PVC pipe. |
| ASTM F800 | Corrugated PVC tubing and compatible fittings. |
| ASTM D3915 | PVC and related plastic pipe and fitting compounds. |
| ASTM F512 | Smooth-wall PVC conduit and fittings for underground installation. |
| ASTM F679 | PVC large diameter plastic gravity sewer pipe and fittings. |
| ASTM F789 | Type PS-46 PVC plastic gravity-flow sewer pipe and fittings. |
| ASTM F758 | Smooth-wall PVC plastic underdrain systems for highway and airport. |

Fiberglass pipe, another material used for flexible pipe systems, is made from glass fiber reinforcements embedded in or surrounded by cured thermosetting resin (7). Since the 1960s, fiberglass pipe has been used for municipal water and sewage applications due to temperature, chemical, abrasion, and weathering resistance. Table 6 shows typical mechanical properties for fiberglass pipe, and Table 7 lists several specifications relevant to fiberglass pipe products.

Table 6. Mechanical Properties Range of Fiberglass Pipe (7).

| | |
|--|-----------------------|
| Tensile strength (psi) | 2000 ~ 80,000 |
| Tensile modulus (psi) | 500,000 ~ 5,000,000 |
| Flexural strength (psi) | 4000 ~ 70,000 |
| Flexural modulus (psi) | 1,000,000 ~ 5,000,000 |
| Coefficient of thermal expansion ($\mu\epsilon/^\circ\text{F}$) ^a | 8 ~ 30 |
| Specific gravity | 1.2 ~ 2.3 |
| Compressive strength (psi) | 10,000 ~ 40,000 |

^a The high coefficient of thermal expansion should be considered in design and installation to accommodate expansion and contraction, especially in aboveground applications. Fiberglass pipe in water system is not affected by service temperatures that generally range from 33°F to 90°F (8).

Table 7. Selected Standards for Fiberglass Pipe (7).

| | |
|------------|---|
| ASTM D2310 | Machine-made fiberglass pipe. |
| ASTM D2517 | Reinforced epoxy resin gas pressure pipe and fittings. |
| ASTM D3262 | Fiberglass sewer pipe (applicable for pipes 8 to 144 in.). |
| ASTM D3517 | Fiberglass pressure pipe (applicable for pipes 8 to 144 in.). |
| ASTM D3567 | Determining dimensions of fiberglass pipe and fittings. |
| ASTM D3839 | Underground installation of fiberglass pipe. |
| ASTM D2105 | Test method for longitudinal tensile properties of fiberglass. |
| ASTM D695 | Test method for compressive properties of rigid plastics. |
| ASTM D1598 | Test method for time-to-failure of plastic pipe under constant internal pressure. |
| ASTM D2143 | Test method for cyclic pressure strength of reinforced pipe. |
| ASTM D2924 | Test method for external pressure resistance of fiberglass pipe. |
| ASTM D5365 | Test method for long-term ring-bending strain of fiberglass pipe. |

Rigid Pipe

Rigid pipes are mainly classified into three types based on material type used: asbestos-cement (AC) pipe, clay pipe, and concrete pipe (1). AC pipes are applicable for both gravity and pressure systems. However, production of this pipe has been halted in the U.S. because of hazardous risks associated with asbestos concrete. Table 8 and Table 9 present typical physical properties used in design and applicable standards for AC pipe.

Table 8. Range of Mechanical Properties of AC Pipe (1).

| | |
|---|----------------------------|
| Modulus of elasticity (psi) | 3,000,000 |
| Tensile strength (psi) | 3,000 ~ 4,000 |
| Shear strength (psi) | 4,000 psi across pipe axis |
| Modulus of rupture (psi) | 5,000 ~ 6,000 |
| Compressive strength (psi) | 7,000 |
| Coefficient of thermal expansion ($\mu\epsilon/^\circ\text{F}$) | 4 ~ 5 |
| Moisture coefficient of expansion (in./in./% of moisture change) | 1.5 ~ 2.0 |

Table 9. Selected Standards for AC Pipe (1).

| | |
|------------|--|
| AWWA C400 | AC distribution pipe, 4 to 16 in. in diameter. |
| AWWA C401 | Selection of AC distribution pipe. |
| AWWA C603 | Installation of AC water pipe. |
| ASTM C296 | AC pressure pipe. |
| ASTM C428 | AC non-pressure sewer pipe. |
| ASTM C500 | Methods of testing AC pipe. |
| ASTM D1869 | Rubber rings for AC water pipe. |

Vitrified clay pipe is manufactured from clay and shale, which are chemically inert (1). This type of pipe is very corrosion and abrasion resistant but only used for non-pressure applications due to its inherent low strength. Available pipe size ranges from 3 to 42 in. in nominal diameter. The strength (as determined by the three-edge bearing test) varies with diameter and ranges from 2000 to 7000 psi (1). Table 10 shows available standards for clay pipe.

Table 10. Selected Standards for Clay Pipe (1).

| | |
|-----------|--|
| ASTM C700 | Clay pipe, vitrified, extra-strength, standard strength, and perforated. |
| ASTM C425 | Compression joints for vitrified clay pipe and fittings. |
| ASTM C301 | Test method for vitrified clay pipe. |
| ASTM C12 | Installing vitrified clay pipe lines. |
| ASTM C828 | Low-pressure air test of vitrified clay pipe lines. |

Several types of concrete pressure pipes are manufactured and used in the U.S. There are pre-stressed concrete cylinder pipe, reinforced concrete cylinder pipe, reinforced concrete non-cylinder pipe, and concrete bar-wrapped cylinder pipe (8). Pre-stressed concrete pipe has been manufactured in the U.S. since 1942 and is the most widely used type of concrete pressure pipe (8). AWWA C301 covers pre-stressed concrete cylinder pipe 16 in. in inside diameter and larger. Lengths are typically 16 to 24 ft. The minimum wall thickness is 1/16 of the pipe diameter. Pre-stressed concrete cylinder pipe has been designed to accommodate pressures greater than 400 psi and earth covers in excess of 100 ft. AWWA C304 covers the design of this type of pipe.

Reinforced concrete pipe was dominant prior to manufacturing of pre-stressed concrete pipe. The difference in construction of this pipe from pre-stressed concrete is that mild steel reinforcement is cast into the wall of the pipe instead of pre-stressing with high strength wire. The minimum wall thickness is 1/12 the inside diameter. AWWA 300 covers design and size of this pipe. Table 11 lists available standards for concrete pipes.

Table 11. Selected Standards for Concrete Pipe (1).

| | |
|-----------|--|
| AWWA C302 | Reinforced concrete pressure pipe, non-cylinder type for water and other liquids. |
| AWWA C303 | Reinforced concrete pressure pipe, steel cylinder type, pre-tensioned for water and other liquids. |
| ASTM C118 | Concrete pipe for irrigation or drainage. |
| ASTM C14 | Concrete sewer, storm drain, and culvert pipe. |
| ASTM C505 | Non-reinforced concrete irrigation pipe with rubber-gasket joints. |
| ASTM C985 | Non-reinforced concrete specified strength culvert, storm drain, and sewer pipe. |
| ASTM C654 | Porous concrete pipe (used as underdrains beneath earth dams). |
| ASTM C506 | Reinforced concrete arch culvert, storm drain, and sewer pipe. |
| ASTM C76 | Reinforced concrete culvert, storm drain, and sewer pipe. |
| ASTM C655 | Reinforced concrete D load culvert, storm drain, and sewer pipe. |
| ASTM C507 | Reinforced concrete elliptical culvert, storm drain, and sewer pipe. |
| ASTM C361 | Reinforced concrete low-pressure pipe. |
| ASTM C924 | Low-pressure air test of concrete pipe sewer lines. |

UNDERGROUND UTILITY STRUCTURE CONSTRUCTION STANDARDS

Underground utility structures such as pipe and conduit systems are expected to withstand induced stresses from live and dead loads, have a robust system of joints and connections, and be somewhat chemically inert with respect to soil and water to serve the expected service life. This section presents details on design or construction parameters for underground utility structures.

Embedment and Backfill

When any type of pipe is installed, soil is a major component of the soil-pipe interaction. The following basic rules of thumb are followed in evaluating buried pipe structures (1):

- A narrow trench should be excavated to have enough side clearance to place the pipe and compact the soil. The minimum clearance between the pipe and the trench wall should be no less than 9 in. (7).
- Minimum bedding thickness of 4 in. should be provided. Full contact of embedment against the pipe should be assured to prevent any voids in the backfill that results in pressure concentration around the pipe.
- Soil protects the pipe based on arching action. Compaction should be conducted on surrounding soil and bedding to create soil arch. However, compaction right over the pipe should be avoided.

- Minimizing native soil disturbance leads to a qualified pipe installation. A bored tunnel or micro tunneling minimizes soil disturbance.
- In saturated soil deposits, most pipes tend to float rather than sink.
- Soil density is a key property in installation of pipes especially when the pipe is installed under the water table. For many soils, the critical density is fairly high and in the range of 88 to 92 percent of standard Proctor density.
- Generally, maximum particle size for backfill material should be limited to 3/4 in. or less. For smaller pipe, a maximum particle size of about 10 percent of the nominal pipe diameter is recommended.
- Coarse and open-graded material should not be placed adjacent to a finer material to prevent migration of fine material resulting in loss of pipe support.

Compaction

When specifying the amount of compaction required, it is crucial to take into account the degree of soil compaction that can economically be achieved in the field. The density and supporting strength of the native soil should be equal to or greater than that of the compacted backfill. The densification of the backfill must include the haunches under the pipe to control both horizontal and vertical pipe deflections (8).

Mechanical compaction of the soil in lifts has been widely used for densifying soils. There are various types of compaction methods: rolling, kneading, impacting, and vibrating. In common practice, density tests are conducted to confirm that the specified compaction is achieved during installation. Vibration compaction is effective in compacting loose soil. Jetting, which uses a high-pressure water jet to flush soil into place against the pipe, is also particularly effective for soil compaction around large buried structures (1).

Casings

Casings can prevent damage to pipe structures caused by soil erosion or settlement in case of pipe failure or leakage (6). Casings provide the following advantages:

- Permit economical pipe removal and placement in the future.
- Accommodate regulations or requirements imposed by public or private owners.
- Permit boring rather than excavation where trenching would not be possible.

Casings are generally sized to provide an inside clearance that is at least 2 in. greater than the maximum outside diameter of the pipe.

Depth of Cover

Depth of cover requirements vary depending on the pipe type, pressure class, soil condition, expected loads, and the condition of the adjacent location. In practice, a minimum 3-ft depth of cover for buried pipes is typical (2).

External Loads

The loads imposed on buried pipes depend upon the stiffness properties of both the pipe structure itself and the surrounding soil, which is frequently called “soil-structure” interaction. As depicted in Figure 2, when designing rigid pipes, it is generally assumed that the pipe is affected mainly by vertical pressure caused by soil and traffic and that the horizontal reacting pressure is negligible. For flexible pipes, the pipe deflection due to the vertical load results in a horizontal reacting soil pressure.

Marston and Anderson developed the Marston theory to determine earth loads on rigid pipes (9). The load on an underground structure is greatly affected by installation conditions and the weight of backfill over the structure. Marston’s formula can be used to assess earth loads for trench conduits and embankment conduits (8).

Trench Conduits

The resultant load on an underground structure is equal to the weight of the material above the top of the conduit minus the shearing or friction forces on the sides of the trench.

$$W_d = C_d \gamma B_d^2 \quad (2)$$

where,

| | | |
|----------|---|--|
| W_d | = | earth load on pipe in trench (lb/linear ft). |
| C_d | = | load coefficient. |
| γ | = | unit weight of backfill (lb/ft ³). |
| B_d | = | width of trench at top of pipe (ft). |

The load coefficient C_d depends upon the soil properties, the width of trench, and the height of backfill, and is calculated as follows:

$$C_d = \frac{1 - e^{-2K\mu'(H/B_d)}}{2K\mu'} \quad (3)$$

where,

| | | |
|--------|---|---|
| H | = | height of backfill above top of pipe (ft) as shown in Figure 2. |
| K | = | Rankine’s ratio. |
| μ' | = | coefficient of friction (between backfill and sides of trench). |

Recommended values of the product $K\mu'$ for various soils are:

- 0.1924 for cohesionless granular materials.
- 0.1650 maximum for sand and gravel.
- 0.15 maximum for saturated top soil.
- 0.13 maximum for ordinary clay.
- 0.11 maximum for saturated clay.

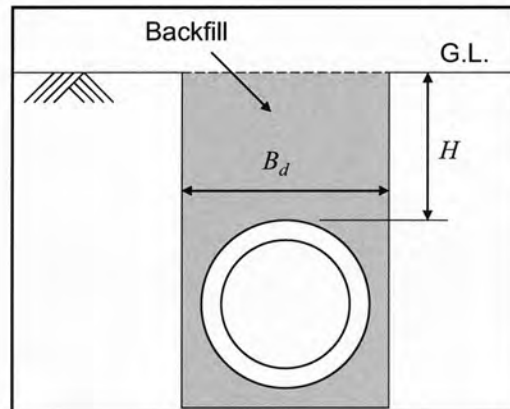

Figure 2. Rigid Pipe in Trench.

In equation (3), the Rankine's ratio (K) is the ratio of active lateral unit pressure to vertical unit pressure. Based on this equation, the load coefficient C_d is plotted as a function of H/B_d for various soil types as defined by $K\mu'$, which is a function of the coefficient of internal friction of the backfill material as shown in Figure 3. Therefore, the load coefficient can be determined using equation (3) or the computational diagram in Figure 3.

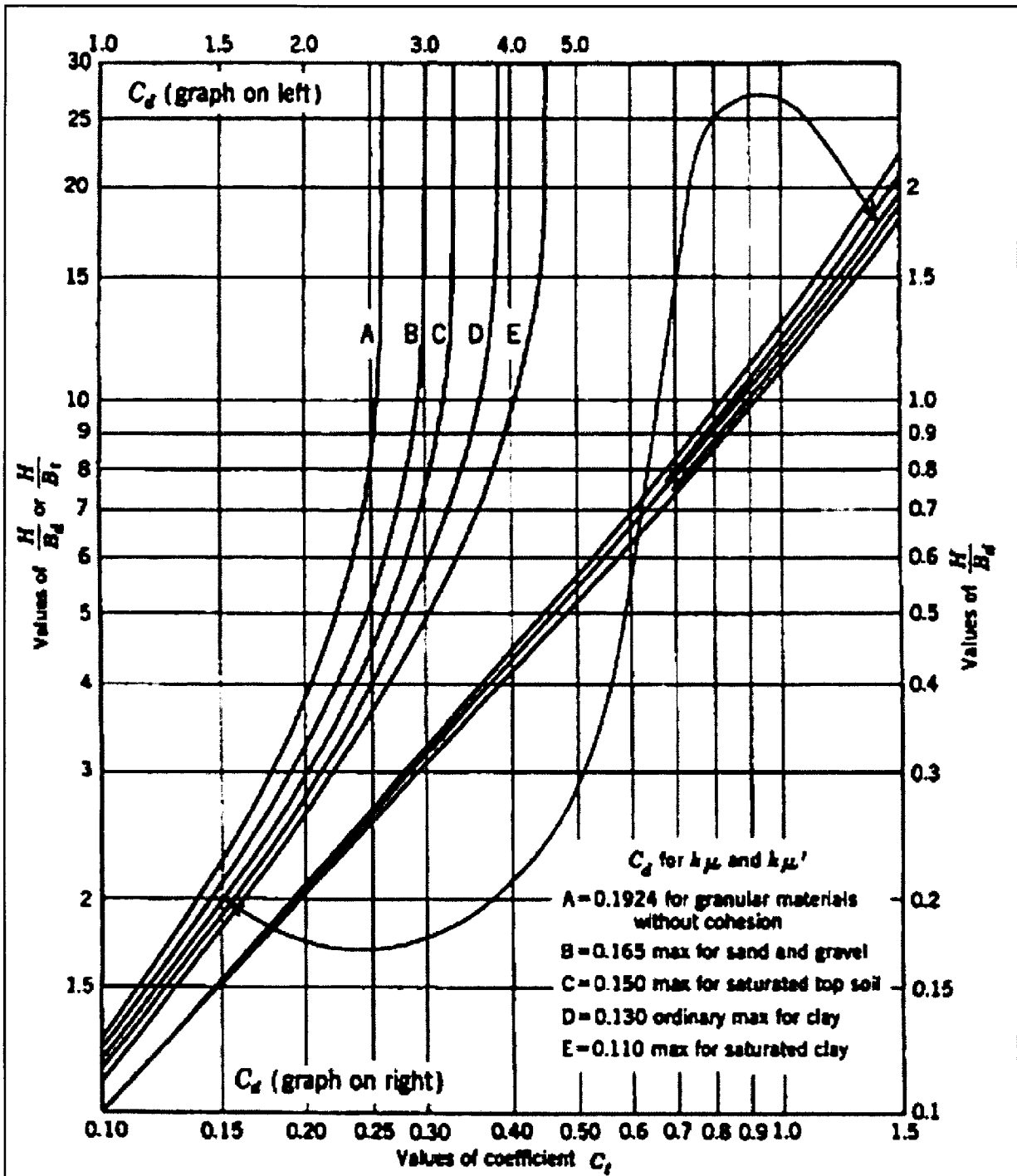

Figure 3. Computational Diagram for Load Coefficient (1).

Embankment Conduits

These conduits are covered by fills or embankments, such as railway embankments, highway embankments, and earth dams. There are three types of installations, as follows:

- Positive projection pipe: The pipe is installed above the natural ground surface without trenching.
- Negative projection pipe: The pipe is installed below the natural ground surface along with relatively shallow trenches.
- Induced trench pipe: The pipe is initially installed as positive projection and then negative projection installation is followed along with trenching.

For positive projection installations, the design considers the settlement of the prism of fill directly above the pipe and bounded by vertical planes tangent to the side of the pipe as shown in Figure 4.

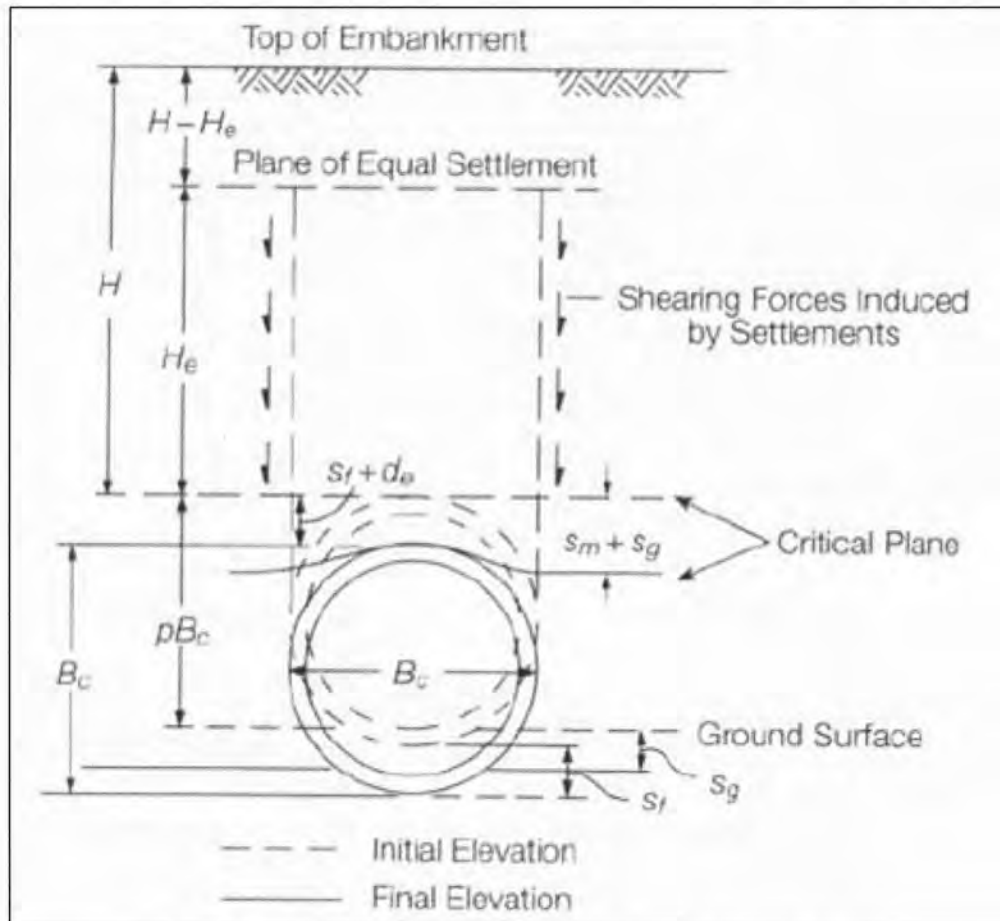

Figure 4. Positive Projecting Embankment Installation (8).

The load on a positive projecting pipe is calculated as follows:

$$W_c = C_c \gamma B_c^2 \quad (4)$$

Parameters are similarly defined as equation (2) except that B_c is the outside diameter of the pipe in feet, and C_c is given as follows:

$$C_c = \frac{e^{\pm 2K\mu(H/B_c)} - 1}{\pm 2K\mu}, \quad H \leq H_e$$

$$C_c = \frac{e^{\pm 2K\mu(H_e/B_c)} - 1}{\pm 2K\mu} + [(H/B_c) - (H_e/B_c)]e^{\pm 2K\mu(H_e/B_c)}, \quad H > H_e \quad (5)$$

Where H_e is the height of the plane of equal settlement above the top of pipe in feet. To calculate C_c , it is necessary to compute H_e from the following equation:

$$\left[\frac{1}{2K\mu} \pm \left(\frac{H}{B_c} - \frac{H_e}{B_c} \right) \pm \frac{r_{sd}P}{3} \right] \frac{e^{\pm 2K\mu(H_e/B_c)} - 1}{\pm 2K\mu} \pm \frac{1}{2} \left(\frac{H_e}{B_c} \right)^2$$

$$\pm \frac{r_{sd}P}{3} \left(\frac{H}{B_c} - \frac{H_e}{B_c} \right) e^{\pm 2K\mu(H_e/B_c)} - \frac{1}{2K\mu} \times \frac{H_e}{B_c} \mp \frac{H}{B_c} \times \frac{H_e}{B_c} = \pm r_{sd}P \frac{H}{B_c} \quad (6)$$

where r_{sd} is a settlement ratio, and p is a projection ratio defined as the vertical distance between the outside top of pipe and the ground or bedding surface divided by the outside diameter of the pipe B_c . The upper signs in equation (6) are used for the incomplete projection condition when r_{sd} is positive, and the lower signs are used for the incomplete trench condition when r_{sd} is negative. Table 12 shows recommended r_{sd} values corresponding to these conditions. In design practice, setting H equal to H_e is generally accepted to solve for H_e . For simplicity, Figure 5 provides a graphical solution for C_c .

Table 12. Design Values of Settlement Ratio (8).

| Installation Condition | Foundation Condition | r_{sd} Design Value |
|------------------------|-------------------------|--------------------------------------|
| Positive projection | Rock or unyielding soil | 1.0 |
| | Ordinary soil | 0.3 for semi-rigid and 0.5 for rigid |
| | Yielding soil | 0.3 |
| Negative projection | $p' = 0.5^a$ | -0.1 |
| | $p' = 1.0$ | -0.3 |
| | $p' = 1.5$ | -0.5 |
| | $p' = 2.0$ | -1.0 |
| Induced trench | $p' = 0.5$ | -0.5 |
| | $p' = 1.0$ | -0.7 |
| | $p' = 1.5$ | -1.0 |
| | $p' = 2.0$ | -2.0 |

^a p' = negative projection ratio, which is the depth of the top of pipe below the critical plane divided by the width of the trench B_d .

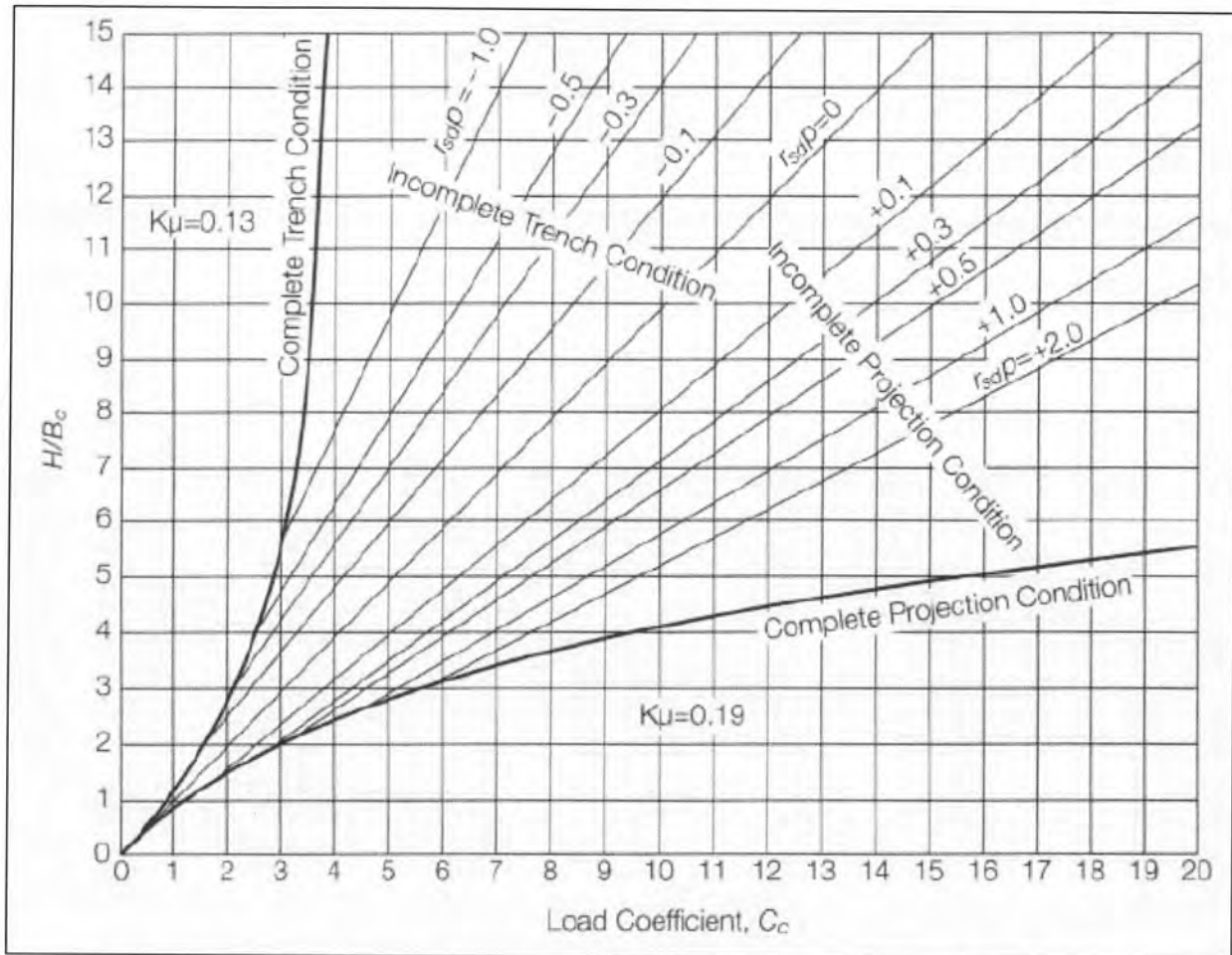
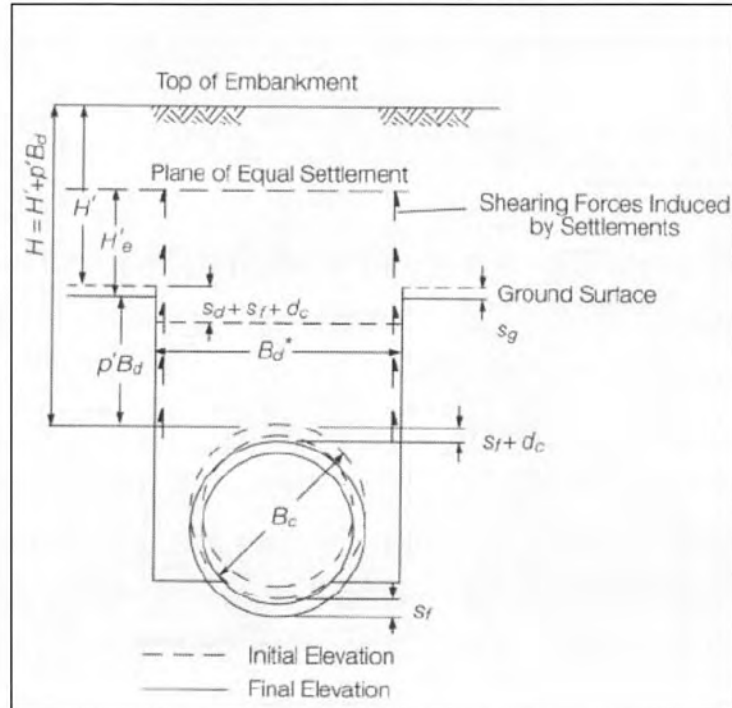

Figure 5. Load Coefficient for Positive Projection Embankment Condition (8).

In negative projection theory, the load transmitted to the pipe is equal to the weight of the interior prism of soil above the pipe minus the frictional forces along the sides of that prism as depicted in Figure 6.

(a) Negative Projecting Embankment



(b) Induced Trench Installation

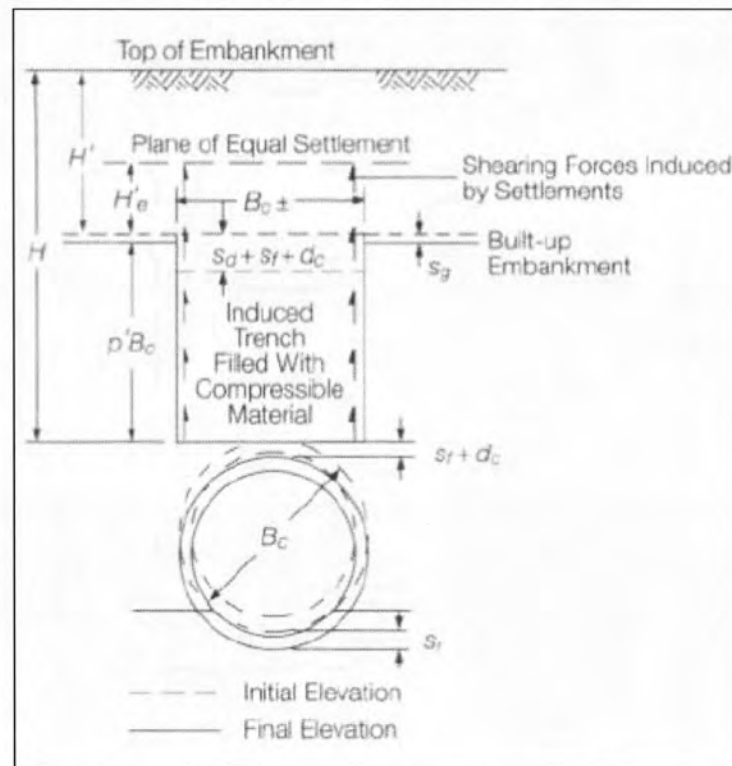

Figure 6. Negative Projecting Embankment and Induced Trench Installation (8).

The load for negative projections and induced trench pipe is computed from the equation:

$$W_n = C_n \gamma B_d^2 \quad (7)$$

C_n is defined as:

$$C_n = \frac{e^{-2K\mu(H/B_d)} - 1}{-2K\mu}, \quad H \leq H_e$$

$$C_n = \frac{e^{-2K\mu(H_e/B_d)} - 1}{-2K\mu} + [(H/B_d) - (H_e/B_d)]e^{-2K\mu(H_e/B_d)}, \quad H > H_e \quad (8)$$

To avoid calculating H_e using the complex equation given earlier for positive projection installations, Figure 7 provides graphical solutions to determine C_n .

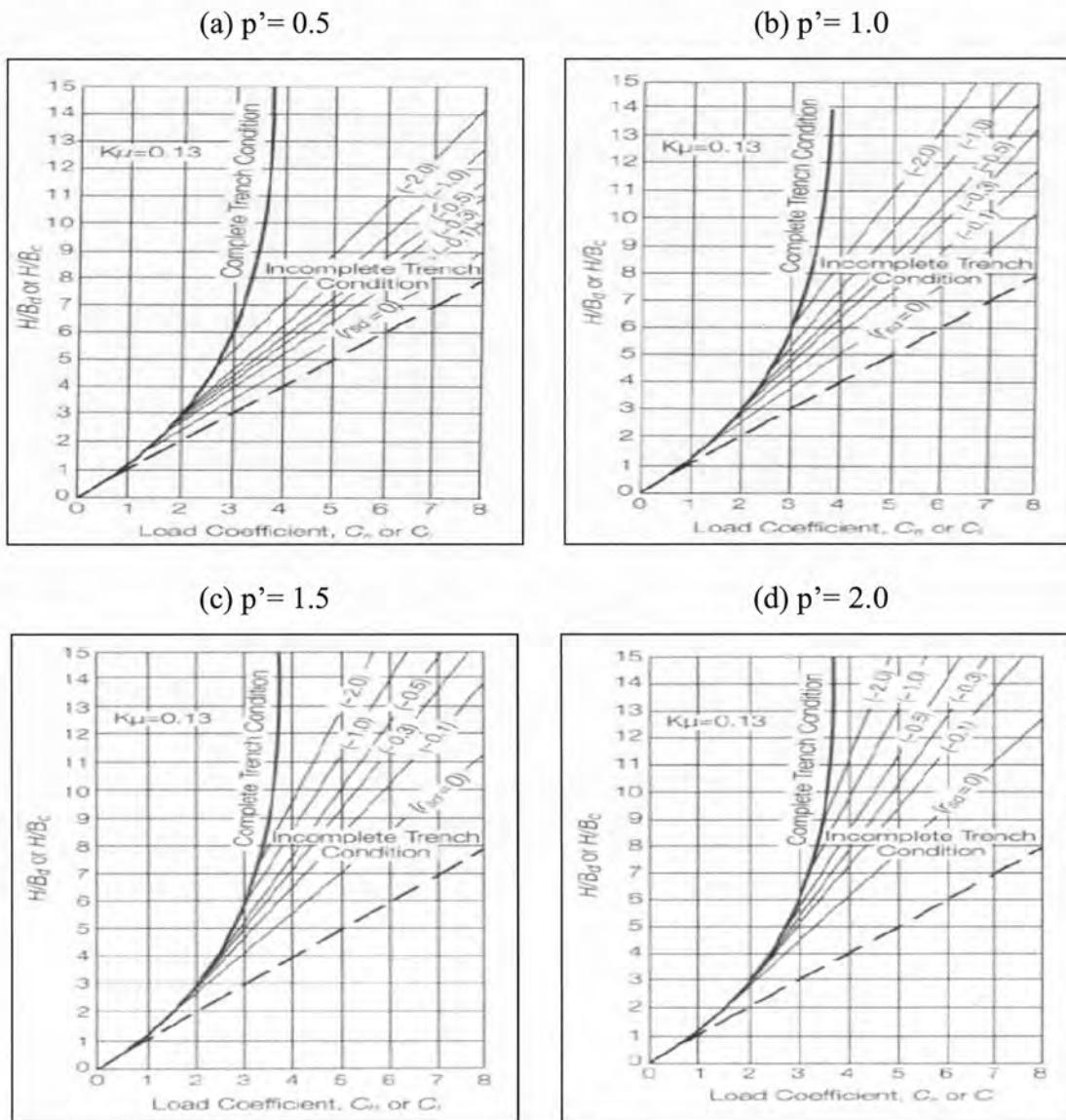

Figure 7. Load Coefficient for Negative Projection and Induced Trench Condition (7).

M. G. Spangler, a student of Anson Marston, discovered that the Marston formula for calculating earth loads on buried pipe was not adequate for a flexible pipe system (1). For flexible pipe evaluation, Spangler incorporated the effects of the surrounding soil on the pipe's deflection based on following assumptions:

- The load applied on the pipe is uniformly distributed along the plane at the top of the pipe.
- A uniform pressure exists over part of the bottom, depending on the bedding angle.
- The horizontal pressure on each side is proportional to the deflection of the pipe.

Spangler developed the original Iowa formula to calculate the horizontal deflection of a buried flexible pipe structure, combining the elastic ring theory and fill-load hypothesis based on the stress distribution diagram shown in Figure 8 (10). Watkins and Spangler revised the original formula to the current "modified" form (11):

$$\frac{\Delta x}{d} (\%) = \frac{100 D_L K P}{0.149 (PS) + 0.061 E'} \quad (9)$$

where,

| | | |
|------------|---|---|
| Δx | = | horizontal deflection. |
| D | = | diameter of undeformed pipe (=2r where r is the pipe radius). |
| P | = | vertical pressure on pipe $\left(= \frac{0.5W_c}{r} \right)$. |
| W_c | = | vertical load on pipe. |
| PS | = | pipe stiffness. |
| E' | = | modulus of soil reaction (= $e \cdot r$). |
| e | = | modulus of passive soil resistance. |
| DL | = | time lag factor (1.0 ~ 1.5). |
| K | = | bedding constant as presented in Table 13. |

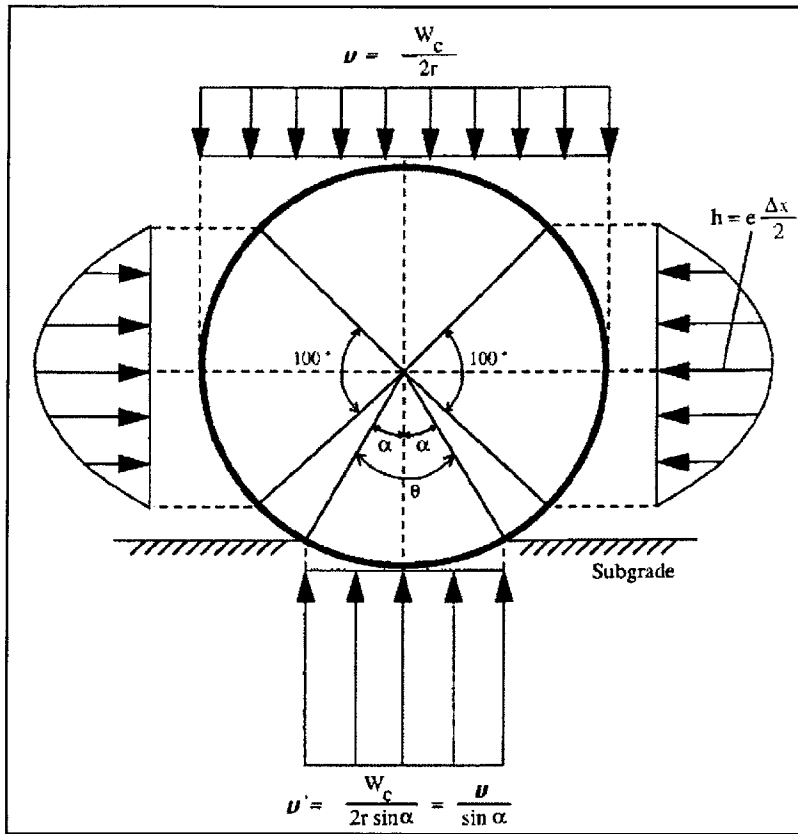

Figure 8. Stress Distributions Hypothesized by Spangler (12).

Table 13. K -Value versus Bedding Angle (12).

| Bedding Angle ($^\circ$) | K |
|----------------------------|--------|
| 0 | 0.1100 |
| 15 | 0.1092 |
| 30 | 0.1075 |
| 45 | 0.1050 |
| 60 | 0.1020 |
| 75 | 0.0986 |
| 90 | 0.0951 |
| 105 | 0.0919 |
| 120 | 0.0890 |
| 135 | 0.0868 |
| 150 | 0.0852 |
| 165 | 0.0844 |
| 180 | 0.0843 |

Allowable pipe deflections for various lining and coating systems are given as follows (1):

- Mortar-lined and coated = 2 percent of pipe diameter.
- Mortar-lined and flexible coated = 3 percent of pipe diameter.
- Flexible lined and coated = 5 percent of pipe diameter.

Equation (9) has been widely used in flexible pipeline designs, even though difficulties have been encountered in its application since the vertical deflection is assumed to be approximately equal to the horizontal deflection. Masada derived an expression for the vertical deflection based on Spangler's theory that is given by the following (12):

$$\frac{\Delta y}{d} = \frac{P}{E'} \left[\frac{KE'}{(0.149PS)} \left\{ \frac{0.0595E'}{(0.149PS) + 0.061E'} - 1 \right\} \right] \quad (10)$$

The above formulas require an estimate of the vertical load on the pipe (W_c) and the modulus of soil reaction (E'). Vertical load is composed of soil and traffic loads. For the case where the flexible pipe is buried in a ditch less than two times the width of the pipe, the earth load is computed as follows (2):

$$W_c = C_d \gamma B_d^2 \left(\frac{B_c}{B_d} \right) \quad (11)$$

where the parameters are as defined previously. B_c is the diameter of pipe in feet. For the case where the pipe is buried in an embankment or wide trench, the load is computed using equation (4). Since the settlement ratio (r_{sd}) is assumed to be zero for flexible pipes, C_c is simply defined as the ratio between the height of fill above top of pipe (H_c) to the pipe diameter B_c . Therefore, the earth load is calculated as:

$$W_c = C_c \gamma B_c^2 = \frac{H_c}{B_c} \gamma B_c^2 = \gamma B_c H_c \quad (12)$$

For use in the Iowa deflection formula given in equation (9), the load obtained from equation (12) should be divided by 12 for U.S. Customary units and by 1000 for metric units.

Live traffic load can be determined based on the requirements of the AASHTO Load and Resistance Factor Design (LRFD) (13). These calculations consider AASHTO standard HS-20 or HS-25 trucks traveling perpendicular to the pipe on an unpaved or paved flexible pavement. The live load on the pipe is determined using the following equation:

$$W_L = \frac{M_p P I_f}{L_1 L_2} \quad (13)$$

where,

| | | |
|-------|---|---|
| W_L | = | live load on pipe (psi). |
| M_p | = | multiple presence factor = 1.2. |
| P | = | wheel load (16 kips for AASHTO Hypothetical Standard (HS)-20 truck and 20 kips for AASHTO HS-25 truck). |
| I_f | = | impact factor. |
| L_1 | = | load width parallel to direction of travel (in.). |
| L_2 | = | load width perpendicular to direction of travel (in.). |

Furthermore,

$$I_f = 1 + 0.33[(96 - h)/96] \geq 1.0 \quad (14)$$

$$L_1 = t_l + LLDF(h) \quad (15)$$

$$L_2 = t_w + LLDF(h) \quad \text{for } h \leq h_{\text{int}} \quad (16)$$

$$L_2 = \frac{t_w + 72 + LLDF(h)}{2} \quad \text{for } h \geq h_{\text{int}} \quad (17)$$

where,

| | | |
|------------------|---|---|
| h | = | depth of cover (in.). |
| t_l | = | length of tire footprint (10 in.). |
| LLDF | = | factor to account for live load distribution with depth of fill (1.15 for backfills SC1 and SC2 and 1.0 for all other backfills). |
| t_w | = | width of tire footprint (20 in.). |
| h_{int} | = | depth at which load from wheels interacts, $\frac{72 - t_w}{LLDF}$. |

The vertical loads on a flexible pipe cause a decrease in the vertical diameter and an increase in the horizontal diameter. The horizontal movement develops a passive soil resistance, which depends on the soil type and degree of compaction (7). The modulus of soil reaction E' is used to characterize soil stiffness in design of flexible pipes and adjusted to the constrained modulus M_s given in equation (18) based on the work done by McGrath (14).

$$M_s = S_C M_{sb} \quad (18)$$

where,

- S_C = dimensionless soil support combining factor presented in Table 14 and Table 15.
- M_{sb} = constrained soil modulus of the pipe zone embedment presented in Table 16.

Table 14. Values for the Soil Support Combining Factor S_C (7).

| M_{sb}/M_{sa} | $B_p/D = 1.25$ | $B_p/D = 1.5$ | $B_p/D = 1.75$ | $B_p/D = 2$ | $B_p/D = 2.5$ | $B_p/D = 3$ | $B_p/D = 4$ | $B_p/D = 5$ |
|-----------------|----------------|---------------|----------------|-------------|---------------|-------------|-------------|-------------|
| 0.005 | 0.02 | 0.05 | 0.08 | 0.12 | 0.23 | 0.43 | 0.72 | 1.00 |
| 0.01 | 0.03 | 0.07 | 0.11 | 0.15 | 0.27 | 0.47 | 0.74 | 1.00 |
| 0.02 | 0.05 | 0.10 | 0.15 | 0.20 | 0.32 | 0.52 | 0.77 | 1.00 |
| 0.05 | 0.10 | 0.15 | 0.20 | 0.27 | 0.38 | 0.58 | 0.80 | 1.00 |
| 0.1 | 0.15 | 0.20 | 0.27 | 0.35 | 0.46 | 0.65 | 0.84 | 1.00 |
| 0.2 | 0.25 | 0.30 | 0.38 | 0.47 | 0.58 | 0.75 | 0.88 | 1.00 |
| 0.4 | 0.45 | 0.50 | 0.56 | 0.64 | 0.75 | 0.85 | 0.93 | 1.00 |
| 0.6 | 0.65 | 0.70 | 0.75 | 0.81 | 0.87 | 0.94 | 0.98 | 1.00 |
| 0.8 | 0.84 | 0.87 | 0.90 | 0.93 | 0.96 | 0.98 | 1.00 | 1.00 |
| 1 | 1.00 | 1.00 | 1.00 | 1.00 | 1.00 | 1.00 | 1.00 | 1.00 |
| 1.5 | 1.40 | 1.30 | 1.20 | 1.12 | 1.06 | 1.03 | 1.00 | 1.00 |
| 2 | 1.70 | 1.50 | 1.40 | 1.30 | 1.20 | 1.10 | 1.05 | 1.00 |
| 3 | 2.20 | 1.80 | 1.65 | 1.50 | 1.35 | 1.20 | 1.10 | 1.00 |
| 25 | 3.00 | 2.20 | 1.90 | 1.70 | 1.50 | 1.30 | 1.15 | 1.00 |

NOTE: In-between values of S_C may be determined by straight-line interpolation from adjacent values.

Table 15. Values for the Constrained Modulus of the Native Soil at Pipe Zone Elevation (7).

| Native In Situ Soils ¹ | | | | | | |
|-----------------------------------|------------------|------------|---------|-----------------|-------------|-------|
| Granular | | Cohesive | | | M_{sb} | |
| | | q_u | | Description | | |
| Blows/ft (0.3 m) | Description | tons/sf | kPa | | Description | psi |
| >0-1 | very, very loose | >0-0.125 | 0-13 | very, very soft | 50 | 0.34 |
| 1-2 | very loose | 0.125-0.25 | 13-25 | very soft | 200 | 1.4 |
| 2-4 | | 0.25-0.50 | 25-50 | soft | 700 | 4.8 |
| 4-8 | loose | 0.50-1.0 | 50-100 | medium | 1,500 | 10.3 |
| 8-15 | slightly compact | 1.0-2.0 | 100-200 | stiff | 3,000 | 20.7 |
| 15-30 | compact | 2.0-4.0 | 200-400 | very stiff | 5,000 | 34.5 |
| 30-50 | dense | 4.0-6.0 | 400-600 | hard | 10,000 | 69.0 |
| >50 | very dense | >6.0 | >600 | very hard | 20,000 | 138.0 |

Table 16. M_{sb} Based on Soil Type and Compaction Condition (7).

| Inch-Pound Units | | | | | |
|--|---|---|----------------------|----------------------|----------------------|
| Vertical Stress Level (see note 5), <i>psi</i> | Depth for γ_s - 120 pcf, <i>ft</i> | Stiffness Categories 1 and 2 (SC1, SC2) | | | |
| | | SPD100, <i>psi</i> | SPD95, <i>psi</i> | SPD90, <i>psi</i> | SPD85, <i>psi</i> |
| 1 | 1.2 | 2,350 | 2,000 | 1,275 | 470 |
| 5 | 6 | 3,450 | 2,600 | 1,500 | 520 |
| 10 | 12 | 4,200 | 3,000 | 1,625 | 570 |
| 20 | 24 | 5,500 | 3,450 | 1,800 | 650 |
| 40 | 48 | 7,500 | 4,250 | 2,100 | 825 |
| 60 | 72 | 9,300 | 5,000 | 2,500 | 1,000 |
| Stiffness Category 3 (SC3) | | | | | |
| 1 | 1.2 | | 1,415 | 670 | 360 |
| 5 | 6 | | 1,670 | 740 | 390 |
| 10 | 12 | | 1,770 | 750 | 400 |
| 20 | 24 | | 1,880 | 790 | 430 |
| 40 | 48 | | 2,090 | 900 | 510 |
| 60 | 72 | | 2,300 | 1,025 | 600 |
| Stiffness Category 4 (SC4) | | | | | |
| 1 | 1.2 | | 530 | 255 | 130 |
| 5 | 6 | | 625 | 320 | 175 |
| 10 | 12 | | 690 | 355 | 200 |
| 20 | 24 | | 740 | 395 | 230 |
| 40 | 48 | | 815 | 460 | 285 |
| 60 | 72 | | 895 | 525 | 345 |

REVIEW OF EXISTING PRACTICE FOR INSTALLATION OF UNDERGROUND UTILITY STRUCTURES IN TEXAS

TTI researchers contacted utility companies and departments of public works in several cities to gather information on their practices for installing buried utilities within the right of way. This contact list included electric, communications, water, and gas/petroleum utility companies as well as local public agencies (Table 17). Through telephone calls, emails, and visits to pertinent websites, researchers gathered the following information, which is documented in the remainder of this section:

- Types of materials used for underground utilities.
- Specifications or guidelines on required depths of cover.
- Typical dimensions such as outer/inner pipe diameters, wall thickness, etc.

- Material specifications such as Young’s modulus, tensile or compressive strengths, allowable stresses, pressures or displacements, and fatigue properties.
- Method or procedure used to design buried utilities, including types of loads considered (for example, overburden pressure, traffic loads, internal pressures for water and gas lines, etc.), determination of required depth of placement, material selection, and sizing of buried utilities.

Table 17. List of Companies and Cities Contacted by Researchers.

| Utility Type | Company/City |
|------------------------------------|------------------------------|
| Communication | AT&T/SBC |
| Gas/Petroleum | Atmos Energy |
| | Exxon Mobile Oil |
| Water, Wastewater, and Storm Water | City of North Richland Hills |
| | City of Fort Worth |
| | City of Grapevine |
| | City of Bedford |

City of Grapevine Water Utility Systems

Water lines in the City of Grapevine are located in the area between the back of the curb and the street right of way, also known as “parkway,” generally 3.5 ft back of the curb on the north side of east-west streets and on the east side of north-south streets. Typical water lines are placed to have a minimum cover depth of 3 ft after grading. Cast-iron, AC, and PVC pipes are used for water lines (15).

Cast-Iron Pipe

Current city standards require ductile iron pipes meeting the requirement of AWWA C151/ANSI A21.51 “Standard for Ductile-Iron Pipe, Centrifugally Cast” (16). The ductile iron pipe should be designed for more than 150 psi working pressure (Class 150) with 100 psi surge allowance for 8-ft cover, trench and truck loads. The pressure class is defined as the rated water working pressure of the pipe in psi. The pipe wall thickness varies with the pressure class as shown in Table 18, which is reproduced from AWWA standard C150/ANSI A21.50 (17).

Table 18. Nominal Thickness for Standard Pressure Classes of Ductile-Iron Pipe (18).

| Size (in.) | Outside diameter (in.) | Pressure Class ^a | | | | | Casting tolerance (in.) |
|---------------|------------------------------|-----------------------------|------|------|------|-------------------|-------------------------------|
| | | Nominal thickness (in.) | | | | | |
| | | 150 | 200 | 250 | 300 | 350 | |
| 3 | 3.96 | — | — | — | — | 0.25 ^b | 0.05 |
| 4 | 4.8 | — | — | — | — | 0.25 ^b | 0.05 |
| 6 | 6.9 | — | — | — | — | 0.25 ^b | 0.05 |
| 8 | 9.05 | — | — | — | — | 0.25 ^b | 0.05 |
| 10 | 11.1 | — | — | — | — | 0.26 | 0.06 |
| 12 | 13.2 | — | — | — | — | 0.28 | 0.06 |
| 14 | 15.3 | — | — | 0.28 | 0.3 | 0.31 | 0.07 |
| 16 | 17.4 | — | — | 0.3 | 0.32 | 0.34 | 0.07 |
| 18 | 19.5 | — | — | 0.31 | 0.34 | 0.36 | 0.07 |
| 20 | 21.6 | — | — | 0.33 | 0.36 | 0.38 | 0.07 |
| 24 | 25.8 | — | 0.33 | 0.37 | 0.4 | 0.43 | 0.07 |
| 30 | 32 | 0.34 | 0.38 | 0.42 | 0.45 | 0.49 | 0.07 |
| 36 | 38.3 | 0.38 | 0.42 | 0.47 | 0.51 | 0.56 | 0.07 |
| 42 | 44.5 | 0.41 | 0.47 | 0.52 | 0.57 | 0.63 | 0.07 |
| 48 | 50.8 | 0.46 | 0.52 | 0.58 | 0.64 | 0.7 | 0.08 |
| 54 | 57.56 | 0.51 | 0.58 | 0.65 | 0.72 | 0.79 | 0.09 |
| 60 | 61.61 | 0.54 | 0.61 | 0.68 | 0.76 | 0.83 | 0.09 |
| 64 | 65.67 | 0.56 | 0.64 | 0.72 | 0.8 | 0.87 | 0.09 |

^aPressure classes are defined as the rated water pressure of the pipe in psi. The thicknesses shown are adequate for the rated water working pressure plus a surge allowance of 100 psi. Calculations are based on a minimum yield strength of 42,000 psi and a 2.0 safety factor times the sum of the working pressure and 100 psi surge allowance.

^bCalculated thicknesses for these sizes and pressure rating are less than 0.25 in., which is the lowest nominal thickness available in these sizes.

Concrete Pressure Pipe

Current city standards require that all concrete cylinder pipes should be manufactured in accordance with AWWA C303-78 or AWWA C301-72 (19, 20). The pipe should be designed for more than 150 psi working pressure (Class 150). The cement used for inside and outside mortar coatings should be Type II Portland cement and the mortar strength should be less than 45 ksi after 28-day, as determined by compression tests on 2 by 2-in. cubes.

Table 19. Dimensions of AWWA C301 Pipe (20).

| Nominal diameter (in.) | Inside diameter (in.) | Core thickness (in.) | Approximate Weight (lb/ft) |
|------------------------|-----------------------|----------------------|----------------------------|
| 15.75 | 15.98 | 0.98 | 154 |
| 17.72 | 17.99 | 1.14 | 181 |
| 19.69 | 20.00 | 1.26 | 201 |
| 23.62 | 24.02 | 1.50 | 255 |
| 29.53 | 30.00 | 1.89 | 376 |
| 35.43 | 35.98 | 2.24 | 476 |
| 41.34 | 42.01 | 2.64 | 651 |
| 47.24 | 47.99 | 2.99 | 825 |
| 53.15 | 54.02 | 3.39 | 979 |
| 59.06 | 60.00 | 3.74 | 1100 |

Asbestos-Cement Pipe

Asbestos-cement pipe for water systems in the City of Grapevine should conform to ASTM C296 or AWWA C400 (21, 22). Design of the pipe must withstand a working pressure of 150 psi for the water distribution line.

PVC Pipe

Current city standards require that PVC pipe for water lines should be Class 150 conforming to AWWA C900 (23). The pipe should be Blue Brute manufactured by Johns Manville or approved equivalent. Table 20 shows the information on Blue Brute pipe for Class 150.

Table 20. Data Sheet for Blue Brute for Class 150^a (24).

| Pipe size (in.) | Average Outer Diameter (in.) | Nominal Inside Diameter (in.) | Minimum Wall Thickness (in.) | Approximate Weight (lb/ft) |
|-----------------|------------------------------|-------------------------------|------------------------------|----------------------------|
| 4 | 4.80 | 4.23 | 0.267 | 5.25 |
| 6 | 6.90 | 6.09 | 0.383 | 6.40 |
| 8 | 9.05 | 7.98 | 0.503 | 7.05 |
| 10 | 11.10 | 9.79 | 0.617 | 8.20 |
| 12 | 13.20 | 11.65 | 0.733 | 8.80 |

^aMinimum burst pressure at 73°F is 755 psi.

City of Grapevine Water Sanitary Sewer System

In the City of Grapevine, sanitary sewer lines are generally located in the street halfway between the street centerline and the curb on the south side of east-west streets and on the west side of north-south streets. Sewer service lines 4 to 15 in. in diameter are required to be PVC. Vitrified clay pipes are required for lines larger than 15 in. in diameter.

PVC Pipe

According to city standards, PVC pipe should meet the requirement of ASTM D 3034 whose dimensions are listed in Table 21 (25). Additional information can be obtained from (26). The standard dimension ratio (SDR) is defined as the ratio of pipe diameter to wall thickness:

$$SDR = \frac{D}{s} \tag{19}$$

where,

- D = pipe outside diameter (mm).
- s = pipe wall thickness (mm).

Figure 9 illustrates the dimensions used in the above formula. A high SDR pipe has a low-pressure rating while a low SDR pipe has a high-pressure rating. The deflection allowance for installed pipe is 5 percent of the inside diameter of the sewer line and the minimum pipe stiffness at the deflection allowance is 46 ksi for all sizes when calculated in accordance with ASTM D 2412 (27).

Table 21. SDR 35 PVC Pipe Dimensions and Weights (26).

| Nominal Pipe Size (in.) | Average Outside Diameter (in.) | Base Inside Diameter (in.) | Minimum Wall Thickness (in.) | Approximate Weight (lb/100') |
|-------------------------|--------------------------------|----------------------------|------------------------------|------------------------------|
| 4 | 4.215 | 3.890 | 0.120 | 110 |
| 6 | 6.275 | 5.742 | 0.180 | 250 |
| 8 | 8.400 | 7.665 | 0.240 | 440 |
| 10 | 10.500 | 9.563 | 0.300 | 690 |
| 12 | 12.500 | 11.361 | 0.360 | 990 |
| 15 | 15.300 | 13.898 | 0.437 | 1500 |
| 18 | 18.701 | 16.976 | 0.536 | 2260 |
| 21 | 22.047 | 20.004 | 0.632 | 3170 |
| 24 | 24.803 | 22.480 | 0.711 | 4030 |

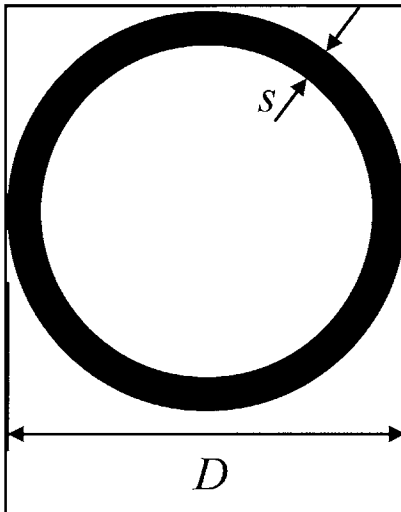

Figure 9. Outside Diameter and Thickness of Pipe.

Vitrified Clay Sewer Pipe

In the City of Grapevine, vitrified clay pipe should be used for all sewer pipes larger than 15 in. in diameter. The pipe should be manufactured in accordance with ASTM C700 (28).

Pipe Embedment and Backfill

Current city standards require that pipelines be installed in trenches filled with sand and/or granular embedment. The minimum and maximum allowable trench widths are determined as the outside pipe diameter plus 12 and 24 in., respectively. The trench wall should be vertical in the pipe zone without any slopes. While water pipe lines are bedded on more than 6 in. of sand material, sewer pipe lines are required to be on a minimum 6 in. of gravel. Sand material is used for backfill of both pipelines, with the sand backfill placed to level at least 12 in. and 6 in. above the top of water and sewer pipes, respectively. Figure 10 illustrates the trench embedment and backfill of each pipeline.

After backfilling, the trench may be filled to the top with sand or native material if the trench is located a minimum of 3 ft from existing or proposed street paving, or in an easement. The materials for embedment and backfill should be wetted to approximate optimum moisture content and compacted using mechanical methods in 12-in. lifts or less. The compaction should be performed to achieve a minimum density of 95 percent of the standard Proctor density for sand or gravel, or 90 percent of the standard Proctor density for native material.

(a) Sanitary Sewer

(b) Water Line

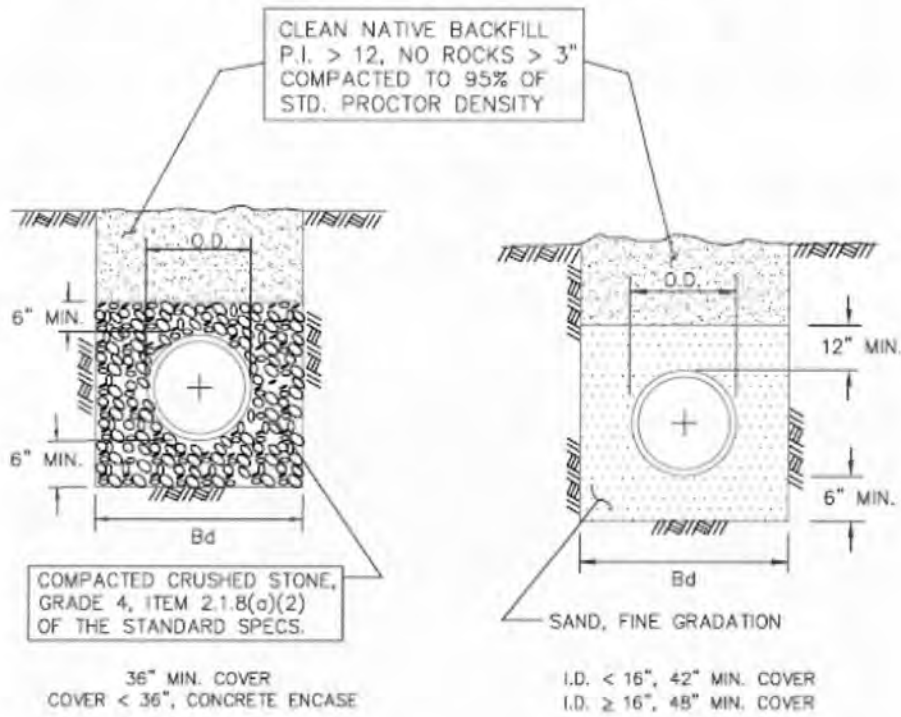

(c) Storm Sewer

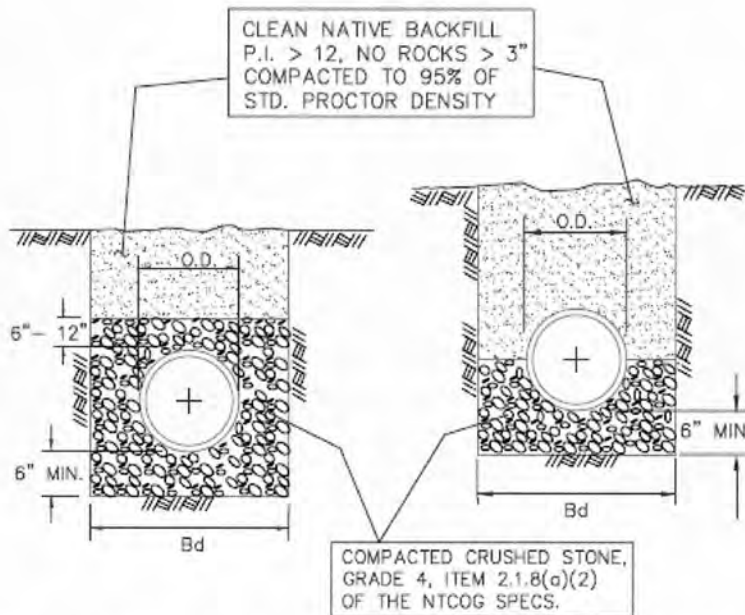

Figure 10. Trench Embedment and Backfill Details (29).

Table 22 lists the gradations of gravel and sand materials used for the embedment and backfill.

Table 22. Gradations of Gravel and Sand Materials.

| Sieve Size | Retained on Sieve (%) | |
|------------|-----------------------|-------------------|
| | Gravel ¹ | Sand ² |
| 1 3/4 | 0 | |
| 1 1/2 | 0 ~ 5 | |
| 3/4 | 30 ~ 65 | |
| 3/8 | 70 ~ 90 | 0 |
| No. 4 | 95 ~ 100 | 0 ~ 5 |
| No. 8 | | 0 ~ 20 |
| No. 16 | | 15 ~ 30 |
| No. 30 | | 35 ~ 75 |
| No. 50 | | 70 ~ 90 |
| No. 100 | | 90 ~ 100 |
| No. 200 | | 97 ~ 100 |

¹ Washed gravel ranging in size from 0.75 in. to 1.25 in. in diameter.

² Plasticity index for the portion passing No. 4 sieve should not be greater than 2.

City of North Richland Hills

Water Utility Systems

In the City of North Richland Hills, all water, sanitary sewer, and drainage installations should be in accordance with the current city standard and specification (30). The water system in the city should be of sufficient size to provide adequate domestic service and fire protection for all lots and to conform to the City’s Master Water Distribution System Plan. The city requires all water pipes to be designed as PVC in accordance with AWWA C900, and SDR 18 for more than 150 psi working pressure (Class 150). Table 23 presents the dimension of AWWA C900 PVC pipe for each pressure class.

Table 23. Data Sheet for Blue Brute for AWWA C900 PVC Pipe (31).

| Pipe Size (in.) | Average Outer Diameter (in.) | Nominal Inside Diameter (in.) | Minimum Wall Thickness (in.) | Approximate Weight (lb/ft) |
|-----------------------------|------------------------------|-------------------------------|------------------------------|----------------------------|
| Pressure Class 150 (SDR 18) | | | | |
| 4 | 4.80 | 4.23 | 0.267 | 5.25 |
| 6 | 6.90 | 6.09 | 0.383 | 6.40 |
| 8 | 9.05 | 7.98 | 0.503 | 7.05 |
| 10 | 11.10 | 9.79 | 0.617 | 8.20 |
| 12 | 13.20 | 11.65 | 0.733 | 8.80 |
| Pressure Class 200 (SDR 14) | | | | |
| 4 | 4.8 | 4.07 | 0.343 | 5.25 |
| 6 | 6.9 | 5.86 | 0.493 | 6.4 |
| 8 | 9.05 | 7.68 | 0.646 | 7.05 |
| 10 | 11.1 | 9.42 | 0.793 | 8.2 |
| 12 | 13.2 | 11.20 | 0.943 | 8.8 |

While the diameter of water pipe in single-family residential areas should be more than 6 in., the pipe diameter in all other areas should be more than 8 in. The depth of water pipe is required to be a minimum of 3 ft for diameters smaller than 10 in., and 3.5 ft for larger than 10 in. However, additional depth (such as more than 5 ft for a limited distance) should be achieved by one of following measures:

- Use pipe deflection if the total length of the deflection can be accomplished within 50 ft for each direction of adjustment.
- Use bend fittings.

Water pipes and storm drain or sanitary sewer pipes should be installed with horizontal separation. The minimum separation between a water pipe and a storm drain is 2.5 ft or half of the depth of the water line, whichever is greater. Water and sanitary sewer pipe lines are separated in accordance with regulations set forth by the Texas Commission on Environmental Quality (32).

Sanitary Sewer Systems

In the City of North Richland Hills, all sanitary sewer pipes should be more than 6 in. in diameter of SDR 35 PVC in accordance with ASTM D3034 (25). All sewer lines should be installed with the maximum depth of 10 ft. If a proposed sewer line will be deeper than 10 ft, then SDR 26 pipe should be used. The minimum separation between any sanitary sewer line and a storm drain facility is 2.5 ft or half of the depth of the sewer line, whichever is greater.

Storm Drainage Systems

Storm drainage pipe embedded in the streets of the city is reinforced concrete, classified as Class III in accordance with ASTM C76 (33). While the minimum size of pipe is 24 in. in diameter, the size is designed based on the calculation of storm runoff in drainage areas. However, if a lateral pipe, which is a small, usually reinforced concrete pipe that conveys water from catch basins or other inlets to the mainline storm drainage pipe, is less than 50 ft, an 18-in. diameter pipe may be used. Figure 11 illustrates a typical storm drainage system under a street in the city.

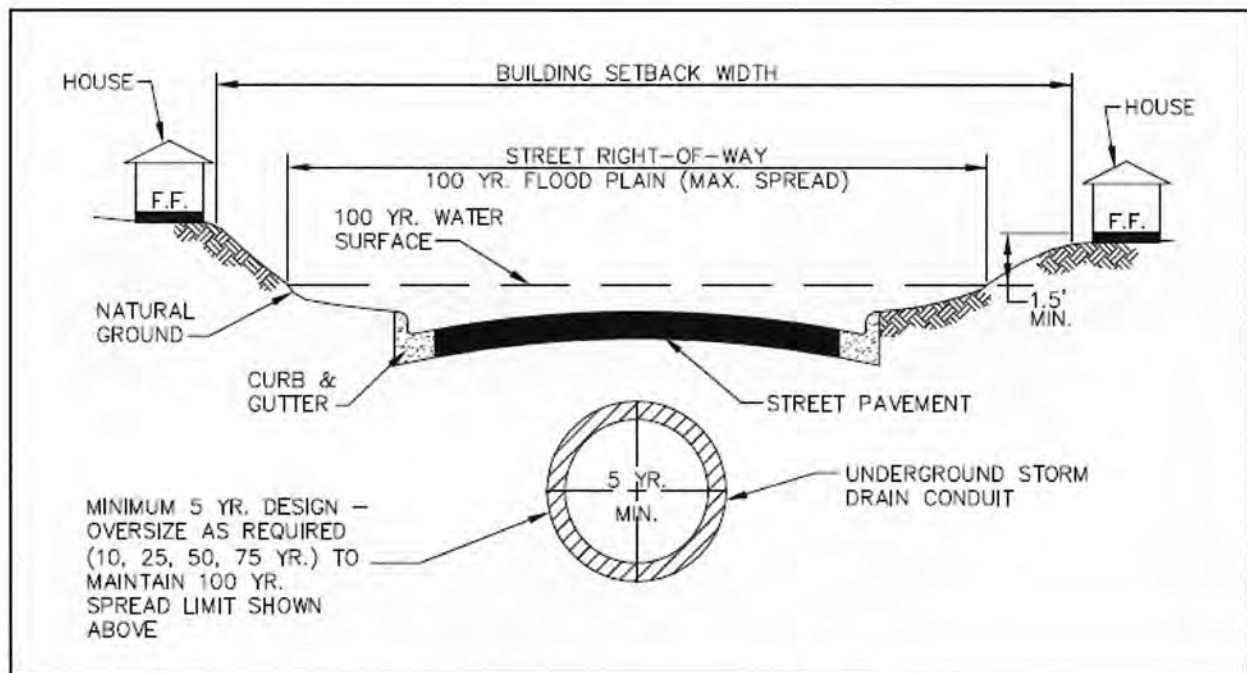

Figure 11. Storm Drain in Street (27).

Trench Embedment and Backfill

In the city, open cutting pavement to install new utilities is not allowed. The contractor must bore the utility under the existing street and use 3/8-in. steel encasement pipe (minimum class 51 steel). Loads exerted on buried pipes can be calculated using the pressure of backfill soil on a pipe for water, sewer, or storm drain. The City of North Richland Hills provides a trench embedment and backfill type for each buried pipe as shown in Figure 12. Compact all trench backfill to 95 percent of the standard Proctor dry density based on ASTM D 698 (34). If trench backfill is compacted mechanically, place the backfill in 6-in. lifts or less.

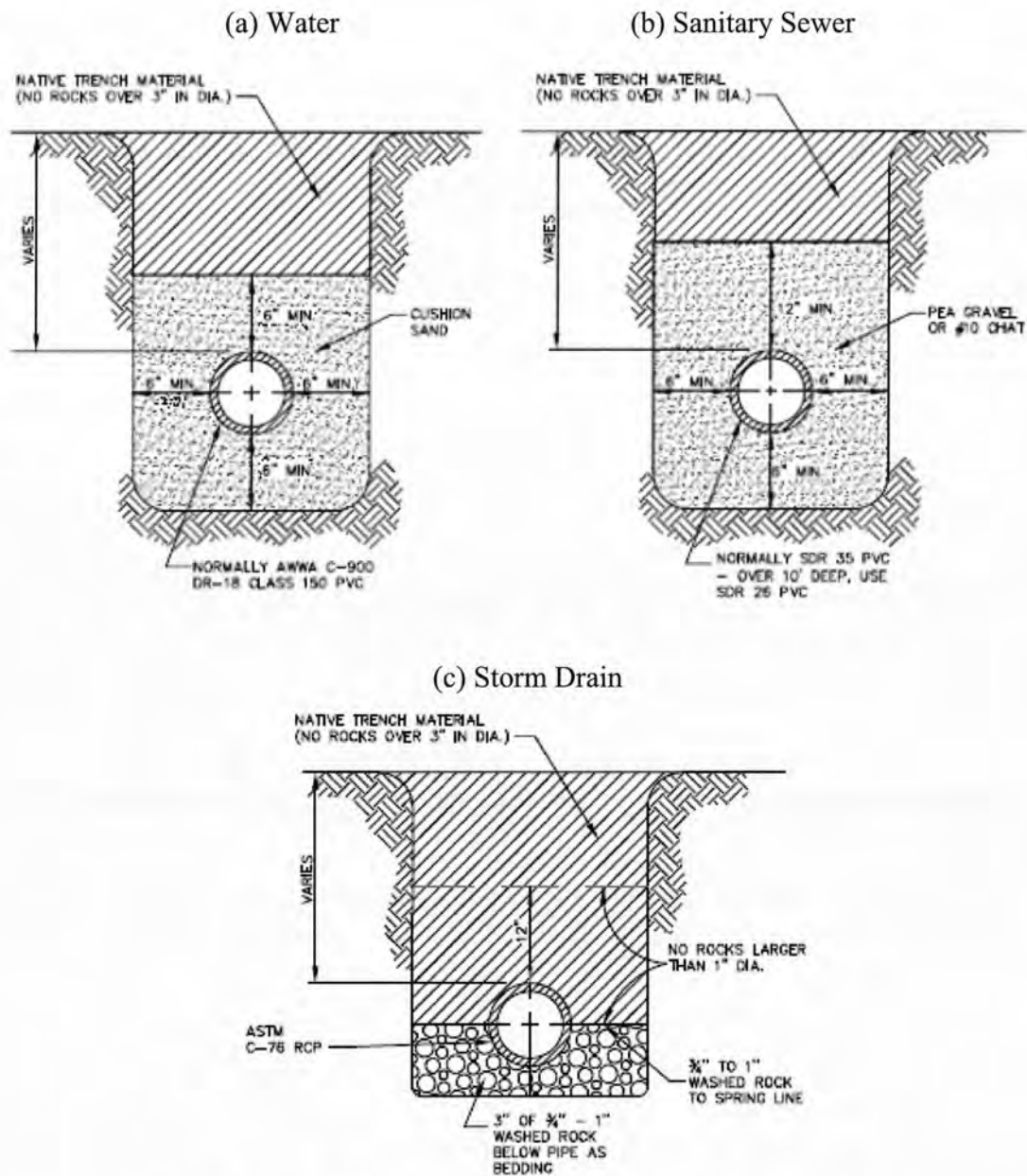

Figure 12. Trench Embedment and Backfill Details.

City of Fort Worth

Water Utility Systems

In the City of Fort Worth, ductile iron pipe in accordance with AWWA C110, AWWA C111, AWWA C150, and AWWA C151 is the preferred material for water utility installations (35, 36, 17, 16). All pipes are required to be cement mortar coated, and all buried pipes must be polyethylene encased. The pressure classes given in Table 24 provide the minimum standard for different pipe sizes.

Table 24. Minimum Pressure Class (37).

| Diameter Pipe (in.) | Minimum Pressure Class (psi) |
|----------------------------|-------------------------------------|
| 3" to 12" | 350 |
| 14" to 20" | 250 |
| 24" | 250 |
| 30" to 64" | 250 |

Concrete pipes that are used in the City of Fort Worth must be designed, manufactured, and tested in accordance with AWWA C303 and AWWA M 9 (38, 8). Steel pipes used in the City of Fort Worth must be designed according to AWWA Manual M 11 and AWWA C200 (2, 3). The design of pipe installations shall be based on trench conditions with the following parameters:

- Unit weight of fill: 130 lb/ft³.
- Live load: AASHTO H-20 truck for unpaved conditions, or Cooper E-80 for railroad conditions.
- Trench depth and width: As indicated in plans, with a minimum depth of cover of 12 in.
- Coefficient $K\mu'$: 0.150 (0.1 for steel pipe), where K = ratio of active lateral unit pressure to vertical unit pressure, and μ' = coefficient of friction between fill materials and sides of trench.
- Maximum calculated deflection: 3 percent for polyurethane coated steel pipe, and 2 percent for mortar coated steel pipe.
- Maximum stress at working pressure: 23 kilopound per square inch, for polyurethane coated steel pipe and 18 kilopound per square inch for mortar coated steel pipe.
- Bedding conditions: as indicated in plans.
- Pressure class: 150 psi minimum working pressure.
- Surge allowance: 100 psi minimum, where total pressure would be 250 psi (working pressure + surge).
- Deflection lag factor: 1.0.
- Soil reaction modulus, E' : less than 1000 psi.

Casing pipe is also widely used in the City of Fort Worth. Casing pipe must be steel conforming to American Society of Mechanical Engineers (ASME) B36.10 and the following special provisions (39):

- Field strength: 35,000 lb per square inch or more.
- Wall thickness: 0.312 in. minimum (0.5 in. for railroad crossings).

Grout must be Portland cement grout with a minimum compressive strength of 2,000 psi at 28 days.

City of Bedford

The research team collected the following information regarding practices for installations of underground utility installations in the City of Bedford. The City of Bedford uses copper, polyvinyl chloride, ductile iron, concrete, concrete cylinder, and high-density polyvinyl chloride (HDPVC) pipes, in addition to steel casing pipe for bores. Depth of cover for underground utility installations are determined using the Marston formula given by equation (2) to calculate allowable depths for concrete pipe, and the Spangler formula given by equation (9) to calculate allowable depths for plastic and composite pipe.

Installations may deviate from the above requirements if the utility contractor, with the approval of the design engineer, has conducted sufficient lab soil tests along the route of proposed installation and can show by approved analysis and recognized procedures that his proposed installation is safe, adequate, and will provide long-term structural integrity under proposed trench loads and depths. The standard bury depths are a minimum of 42 in. of cover for water lines and 60 in. of cover if adjacent to thoroughfares and major roadways. The City of Bedford also has the following requirements and specifications for pipe dimensions, materials, and design methods:

- **Pipe Dimensions.** Typical pipe dimensions should be established in accordance with the specifications in Table 25.
- **Material Specifications.** The City of Bedford has very few additional specification requirements for underground utilities. The city usually relies on the relevant ASTM, AWWA, design engineer, or product specifications. For example, the City of Bedford requires all water or sanitary sewer lines with less than 24 in. of cover to be constructed of ductile iron pipe with concrete encasement as needed.
- **Method of Design.** In general, most underground utility installations are classified as “standard laying condition” environments that are not normally subject to excessive or potentially damaging loads over the respective trench line areas. The City of Bedford’s preferred requirement for pipe bedding is Type 4 with crushed stone bedding under and adjacent to the pipe with a tamped or compacted (95 percent) ASTM D698/AASHTO T-99 backfill area from pipe zone to top of ditch (34). Trench load is based on AASHTO H-20 single truck on flexible pavement. For situations that require excessive depth of cover over utility lines, the City of Bedford requires an evaluation by the design engineer for analysis and recommendations on type of pipe to be used, treatment of backfill material, trench design, and all calculations necessary to install the proposed utility. The data are then submitted to the city engineer for review and comment.

Table 25. City of Bedford Specifications for Pipe Dimensions.

| Material Type | Specification |
|-------------------------------------|---|
| Concrete (storm drains) | ASTM C76/Class III /Class IV (33) |
| Pretensioned Concrete Cylinder Pipe | AWWA C303 (19) |
| Copper Pipe | ASTM B88, Type K / AWWA C800 Type K (40, 41) |
| Ductile Iron | ANSI/AWWA C150/A21.50, ANSI/AWWA C151/A21.51 (17, 16) |
| PVC Water | |
| Class 150 (SDR 18) | AWWA C900 (23) |
| PVC Sanitary Sewer | |
| SDR 35 | ASTM D3034 (25) |
| SDR 26 | ASTM D2241 (42) |
| Schedule 40 | ASTM D1785 (43) |
| HDPVC Sewer Pipe Lining | ASTM D3035/F-714, AWWA C901, and AWWA C906 (44, 45, 46) |

Exxon Mobile Pipeline Company

The research team collected the following general requirements for installation and modification of pipelines, roads, and utility lines crossing existing Exxon Mobile Pipeline Company (EMPCo) pipelines:

- All pipelines, utility lines, and other underground facilities (except electrical power and telecommunications cables) constructed across EMPCo pipelines shall cross the pipeline easement at an angle of 30 degrees or more, must be under the EMPCo pipelines with a minimum vertical separation of 24 in. between structures.
- Electrical power cables must be enclosed in conduit made of steel or PVC and covered with concrete over a minimum width of 6 in. on each side and above the conduit. The conduit and concrete must extend a minimum of 25 ft on either side of the centerline of EMPCo pipelines.
- Any road, driveway, or street should cross the pipeline easement at an angle of 30 degrees, and be constructed with a depth of cover, as measured from the top of the pipelines to the top of the surface of the road, driveway, or street as shown in Table 26.
- No trucks or heavy equipment should cross the pipeline right of way without approval from EMPCo. If EMPCo determines that the integrity of the pipelines based on soil conditions, depth, and character of the pipelines may be jeopardized, a temporary road crossing will be built to the specifications of EMPCo.

Table 26. Exxon Mobile Pipeline Specifications for Depth of Cover.

| Location | Minimum cover (in.) |
|--|----------------------------|
| Under driveway on residential lot | 18 |
| Under all other surfaces within the right of way | 36 |
| Under road or street | 48 |

ATMOS Energy

ATMOS Energy provided the following information about underground utility installation standards and practices:

- **Types of materials used for underground utilities.** ATMOS Energy uses medium density polyethylene (MDPE) for internal pressures of 60 psig or less, and steel for pressures greater than 60 psig.
- **Specifications or guidelines on required depths of placement.** The normal depth of cover for utility lines is 36 to 48 in. Steel pipe under roadways typically has 60 in. depth of cover.
- **Typical pipe dimensions.** ATMOS Energy uses iron or steel pipe with nominal outside diameters of 2 to 36 in. and PVC pipes with 2 to 12 in. nominal outside diameters. Typical wall thickness is 0.188 in. and thicker.
- **Utility facility material specifications.** For steel pipe, ATMOS Energy uses a Young's modulus of 29,000,000 psi, internal pressures up to 1000 psig, and allowable internal stresses generally 20 to 50 percent of the specified minimum yield stress.
- **Types of loads considered.** Pipe design considers both internal pressure and traffic loading.

REVIEW OF MILITARY SPECIFICATIONS FOR UNDERGROUND UTILITIES

Introduction

The research team conducted a review of military specifications for underground utilities that are included in the Unified Facilities Guide Specifications (UFGS). This set of specifications is maintained through a joint effort of the U.S. Army Corps of Engineers (USACE), the Naval Facilities Engineering Command (NAVFAC), the Air Force Civil Engineer Support Agency (AFCESA), and the National Aeronautics and Space Administration (NASA). UFGS are used to specify construction for the military services. This review covers specifications for water distribution, sanitary sewers, and natural gas/liquid petroleum piping.

Water Distribution

UFGS section 33 11 00 covers requirements for potable and non-potable water distribution systems in which the largest sized pipe is 24 in. in diameter, and the maximum working pressure does not exceed 200 psi for pipes 12 in. and smaller, and 150 psi for pipes larger than 12 in. (47). The specification covers exterior water distribution systems only, including water supply, distribution/service lines, and connections to a point approximately 5 ft outside of buildings and structures.

Requirements for Water Distribution Mains

For Army projects, UFGS section 33 11 00 stipulates referencing Unified Facilities Criteria (UFC) 3-230-10A *Water Supply: Water Distribution* for design considerations in pipe material selection (48). Ferrous metal piping is not allowed to be buried in the vicinity of switchyards or hydroelectric powerhouses due to experience with rapid failure of this pipe as a result of galvanic corrosion from nearby large copper ground mats. For Navy projects, ductile-iron, molecularly oriented polyvinyl chloride (PVCO), or PVC pressure pipes may be specified for water distribution mains 4 to 12 in. in diameter. For larger sized mains, use ductile-iron or concrete pipes. Table 27 summarizes the pertinent requirements for the different pipe materials allowed in this specification.

Table 27. Summary of Requirements for Water Distribution Mains.

| Pipe Material | Design/Material Requirements |
|--|---|
| Ductile-Iron | <ul style="list-style-type: none"> • Determine pressure/thickness class using AWWA C151/A21.51 <i>Tables for Pressure Class and Thickness Class</i> (16). • Include UFGS section 26 42 13.00 20 <i>Cathodic Protection by Galvanic Anode</i> for underground pipe installations in a corrosive environment (49). • Cement-mortar linings with twice the standard thickness may be specified for pipes conveying unusually aggressive waters following AWWA C104/A21.4 (50). • Polyethylene encasement will apply where soil conditions warrant, in accordance with Appendix A of AWWA C105/A21.5 (51). |
| PVC/PVCO | <ul style="list-style-type: none"> • Use pressure class 150 (DR 18) except when pressure class 200 (DR14) is necessary (refer to Appendix A of AWWA C900) (23). • Use only pressure class 150 for PVCO pipe with cast-iron-pipe equivalent OD. • Do not use PVC when pipe of greater strength than class 200 is required due to external loading. • Do not use plastic when the pipe will be subjected to temperatures in excess of 100°F or exposed to heat from adjacent lines or equipment under installed usage. |
| Polyethylene (PE) | <ul style="list-style-type: none"> • PE pipes, tubings, and heat-fusion fittings shall conform to AWWA C906 (46). |
| Reinforced Thermo-Setting Resin Pipe (RTRP) | <ul style="list-style-type: none"> • RTRP is not used on Navy projects. • Refer to AWWA M45 for design considerations (7). • RTRP pipe shall have a quick-burst strength of at least four times the normal working pressure determined in accordance with ASTM D1599 (52). <p>RTRP type I pipe (filament bound) shall conform to ASTM D2996 except that the pipe shall have an outside diameter equal to cast iron or standard weight steep pipe outside diameter (53). The pipe shall be suitable for a normal working pressure of 150 psi at 73°F and be lined on the inner surface with a smooth uniform continuous resin-rich material conforming to ASTM D 2996. All RTRP-I materials shall come from one manufacturer.</p> <ul style="list-style-type: none"> • RTRP type II pipe (centrifugally cast) shall conform to ASTM D 2997, with an outside diameter equal to that of standard weight steel pipe (54). |
| Reinforced Plastic Mortar Pressure Pipe (RPMP) | <ul style="list-style-type: none"> • RPMP is not used on Navy projects. • Refer to AWWA M45 for design considerations (7). • RPMP pipe shall be in accordance with AWWA C950 (55). • RPMP shall be produced by centrifugal casting, and shall have a 150 psi pressure rating with a minimum pipe stiffness of 36 psi. |

Table 27. Summary of Requirements for Water Distribution Mains (Continued).

| Pipe Material | Design/Material Requirements |
|--------------------------------------|---|
| Reinforced and Pre-Stressed Concrete | <ul style="list-style-type: none"> • Concrete pipes are used for raw water. • Use 150 psi pressure rating except when a higher rating, up to 200 psi, is necessary. • AWWA recommends a minimum 6 ft depth of earth cover for ordinary conditions. However, the engineer can specify a different depth and pressure rating for designing the pipe. Applicable AWWA publications for different pipe diameters are given in the following list: <ul style="list-style-type: none"> ➤ 10 to 42 in. OD: AWWA C303 (reinforced concrete) (38). ➤ 24 to 144 in. OD: AWWA C300 (reinforced concrete) (56). ➤ 16 to 144 in. OD: AWWA C301 (prestressed concrete) (57). • In localities where 6- and 8-in. prestressed concrete pipes are available, the pipes shall conform to AWWA C303 with the following exceptions: <ul style="list-style-type: none"> ➤ Nominal lining thickness: 0.25 in. ➤ Nominal coating thickness: 1 in. ➤ Class 150 total steel area: 0.94 in.²/ft. ➤ Class 150 minimum steel cylinder thickness: 16 gauge. • Minimum conditions used for pipe design are AASHTO H 20 truck loading and water hammer pressure equal to 40 percent of pressure rating. • In areas of the U.S. where pipe will convey sulfate-bearing waters or where pipe will be buried in soils containing sulfates, specify concrete pipe made of sulfate-resisting cement. Cement type to be used varies according to sulfate concentrations as follows: <ul style="list-style-type: none"> ➤ From 0.1 to 0.2 percent sulfates in soil, or 150 to 1000 ppm in water: Type II cement. ➤ Greater than 0.2 percent sulfates in soil or higher than 1000 ppm in water: Type V cement. • In areas where reactive aggregates are known to occur, specify low-alkali cement. |
| Steel | <ul style="list-style-type: none"> • Steel pipes shall conform to AWWA C200 (3). • Pipes and fittings for underground lines shall have cement-mortar lining, and cement-mortar, coal-tar enamel, or coal-tar epoxy coating. Refer to the AWWA M11 chapter on protective coatings for information on the relative merits of cement-mortar and coal-tar enamel coatings (2). See foreword to AWWA C210 for information on coal-tar epoxy coating (58). The following requirements apply for linings and coatings: <ul style="list-style-type: none"> ➤ Under ordinary conditions, steel pipes come furnished with factory-applied cement-mortar lining. If in-place cement-mortar lining will be done during construction, the materials for this lining shall conform to AWWA C602 (59). ➤ If cement-mortar lining and cement-mortar coating are to be applied at the shop, the applicable provisions in AWWA C205 shall be used (60). |

Table 27. Summary of Requirements for Water Distribution Mains (Continued).

| Pipe Material | Design/Material Requirements |
|-------------------|---|
| Steel (continued) | <ul style="list-style-type: none"> ➤ For high-sulfate soils or waters, specify cement conforming to ASTM C 150/C 150M Type II Portland cement (17). When reactive aggregates are used, specify cement conforming to ASTM C 150/C 150M low-alkali Portland cement. ➤ Except as otherwise specified, prepare, prime, and coat pipe with hot-applied coal-tar enamel and a bonded single layer of felt wrap in accordance with AWWA C203, or double felt wraps in accordance with AWWA C203 (61). Apply double felt wraps when pipe is to be buried in soil classified as Group IV, unusually corrosive as defined in chapter 10 of AWWA M11; or as Class 4, extreme, as defined in the Navy Design Manual on water supply systems; or where the electrical soil resistivity has been measured at less than 2000 ohms/cc (2). Asbestos felt is not permitted. The felt material shall be fibrous-glass mat as specified in Section 10 of AWWA C203 (61). Shop-apply coating. ➤ Coal-tar epoxy coating shall be applied at the shop in accordance with AWWA C210 (58). • The wall thickness of steel pipe and fittings is determined by the pipe manufacturer based on the minimum conditions specified in the plans that include the pressure rating and earth cover. The design shall be carried out in accordance with the methods given in chapters 4, 5, and 6 of AWWA M11 (2). The engineer specifies a 150 psi pressure rating for design except when a higher rating, up to 200 psi, is deemed necessary. A minimum earth cover of 5 ft is recommended for ordinary conditions. Other minimum conditions used in determining the pipe wall thickness are: <ul style="list-style-type: none"> ➤ Water hammer: 40 percent of pressure rating ➤ Live load: AASHTO H 20 truck loading ➤ Allowable deflection: 2 percent of nominal pipe diameter <p>For calculating the wall thickness of the steel water main, the designer shall use a realistic value for the modulus of soil reaction based on the expected fill compaction, as opposed to assuming a theoretical value. The wall thickness is determined based on an allowable fiber stress equal to 50 percent of the minimum yield strength of the steel pipe. The yield strength is specified in the plans.</p> |

In Table 27, RTRP and RPMP are fiberglass pipes that can be used for potable water systems. Advantages associated with fiberglass material are durability and corrosion resistance, which eliminate the need for linings or coatings. However, the engineer should pay special attention to bedding and pipe support requirements. Pipe leaks are difficult to locate due to the manufacturing process.

RTRP pipes are classified by the method of manufacture as type I (filament bound) or type II (centrifugally cast). Pipe grade is determined by construction and bonding material. Grade 1 is glass-fiber reinforced epoxy, while Grade 2 is glass-fiber reinforced polyester.

Requirements for Water Service Lines

UFGS section 33 11 00 does not expect working pressures in service lines to exceed 150 psi. Should the need arise to install service lines with operating pressures in excess of 150 psi, section 33 11 00 advises the engineer to consult the various pipe, fitting, and valve specifications referenced in this UFGS section to determine the applicable pressure rating designation for the given material and higher pressure. The engineer should then modify the appropriate paragraphs in section 33 11 00 as necessary, and insert these modifications in the plans. Table 28 summarizes the UFGS requirements for water service lines.

Installation Requirements

UFGS section 33 11 00 provides specifications for installation of pipelines that include location of water lines, earthwork, pipe laying and jointing, connections to existing water lines, penetrations (i.e., pipes passing through walls of valve pits and structures), and installation of water mains, service lines, and tracer wire. Table 29, Table 30, and Table 31 summarize, respectively, installation requirements related to earthwork, water mains, and service lines that are considered relevant to this research project. For information on installation requirements covering other areas, please refer to UFGS section 33 11 00.

Table 28. Summary of Requirements for Water Service Lines.

| Pipe Material | Design/Material Requirements |
|------------------------------------|---|
| Copper | <ul style="list-style-type: none"> • Pipe shall conform to ASTM B42 with regular, threaded ends (62). • Fittings shall be brass or bronze conforming to ASME B16.15, 125 psi rating (63). • Tubings shall conform to ASTM B88, Type K (40). • Fittings for solder-type joint shall conform to ASME B16.18 or ASME B16.22 while fittings for compression-type joint shall conform to ASME B16.26, flared tube type (64, 65, 66). |
| PVC with screw joints | <ul style="list-style-type: none"> • ASTM D 1785 Schedule 40 or ASTM D 2241 with standard dimension ratio (SDR)* selected to provide 150 psi minimum pressure rating (43, 42). • Fittings shall conform to ASTM D 2466 or ASTM D 2467 (67, 68). • Pipes and fittings shall be made of the same plastic material and fall into one of the pipe/fitting combinations listed in UFGS 33 11 00 (47). |
| PVC with elastomeric-gasket joints | <ul style="list-style-type: none"> • Pipe shall conform to dimensional requirements given in ASTM D 1785 Schedule 40, with joints meeting requirements for 150 psi working pressure and 200 psi hydrostatic test pressure, unless otherwise shown or specified in the plans (43). |
| PVC with solvent cement joints | <ul style="list-style-type: none"> • Pipe shall conform to dimensional requirements given in ASTM D 1785 or ASTM D 2241, with joints meeting requirements for 150 psi working pressure and 200 psi hydrostatic test pressure (43, 42). |
| PE plastic pipe | <ul style="list-style-type: none"> • Pipe tubing and heat fusion fitting shall conform to AWWA C901 (45). |

Table 28. Summary of Requirements for Water Service Lines (Continued).

| Pipe Material | Design/Material Requirements |
|---------------------------------------|---|
| Acrylonitrile-butadiene-styrene (ABS) | <ul style="list-style-type: none"> • ASTM D 1527 or ASTM D 2282, with pipe schedule or SDR selected as necessary to provide 150 psi minimum pressure rating (69, 70). • Fittings shall conform to ASTM D 2468, selected as required to provide barrel wall thickness not less than that of pipe (71). • Solvent cement for jointing shall conform to ASTM D 2235 (72). |
| PVC | <ul style="list-style-type: none"> • AWWA C909, plain end or gasket bell end, pressure class 150 with cast iron pipe equivalent outside diameter (73). |
| RTRP | <ul style="list-style-type: none"> • Table 1 requirements for RTRP water mains also apply to RTRP pipes used for water service lines. • RTRP-I joints shall be bell and spigot with elastomeric gasket, mechanical coupling with elastomeric gasket, threaded and bonded coupling, or tapered bell and spigot with compatible adhesive. • RTRP-II joints shall be the bell and spigot type with elastomeric gasket; bell and spigot with adhesive; butt-jointed with adhesive bonded reinforced overlay; or mechanical, flanged, threaded or commercially available proprietary joints, provided they are capable of conveying water at the pressure and temperature of the pipe. |
| RPMP | <ul style="list-style-type: none"> • Table 1 requirements for RPMP water mains also apply to RPMP pipes used for water service lines. <p>Fittings and specials shall be compatible with the pipe supplied, and suitable for the working and testing pressures specified for the pipe. The following provides additional requirements for pipe fittings:</p> <ul style="list-style-type: none"> ➤ Filament wound or molded fittings up to 6 in. in diameter shall conform to AWWA C950 (55). ➤ Iron fittings shall be cement-mortar lined in accordance with AWWA C104/A21.4, and shall conform to AWWA C110/A21.10 and AWWA C111/A21.11 (50, 35, 36). <ul style="list-style-type: none"> • Joints shall be bell and spigot gasket coupling utilizing an elastomeric gasket in accordance with ASTM D 4161 (74). |
| Steel | <ul style="list-style-type: none"> • Steel pipes shall conform to ASTM A 53/A 53M, standard weight, zinc-coated (75, 76). • Fittings shall conform to ASME B16.4, class 125, zinc-coated or to ASME B16.3, class 150, zinc-coated and threaded (77, 78). • Protective materials for galvanized pipe less than 3 in. in diameter will be required only when the pipe is within the zone of influence of adjacent buried cathodic protection systems. |

Table 28. Summary of Requirements for Water Service Lines (Continued).

| Pipe Material | Design/Material Requirements |
|-------------------|---|
| Steel (continued) | <ul style="list-style-type: none"> • Protective materials for steel pipe, except as otherwise specified, shall be mechanically applied in a factory or plant especially equipped for this purpose. Pipes and fittings less than 3 in. in diameter shall be thoroughly cleaned of foreign material by wire brushing and solvent cleaning, and then given 1 coat of coal-tar primer and 2 coats of coal-tar enamel conforming to AWWA C203 (61). Threaded ends of pipes and fittings shall be adequately protected prior to coating. |
| Ductile-iron | <ul style="list-style-type: none"> • Table 1 requirements for ductile-iron water mains also apply to ductile-iron water service lines. |

*SDR is the ratio of the pipe diameter to wall thickness.

Table 29. Summary of Installation Requirements Related to Earthwork.

| Item | Installation Requirements |
|---------------------------|--|
| Pipe trenches | <ul style="list-style-type: none"> • Excavate to the dimensions indicated on plans. • Grade bottom of trenches to provide uniform support for each section of pipe after pipe bedding placement. Tamp if necessary to provide a firm pipe bed. Excavate recesses to accommodate bells and joints to provide uniform pipe support throughout entire length. • Where rock is encountered, excavate to a depth of at least 6 in. below the bottom of the pipe. |
| Pipe bedding and backfill | <ul style="list-style-type: none"> • Except as specified otherwise, provide bedding for buried piping in accordance with AWWA C600, Type 4 (79). • Backfill to top of pipe shall be compacted to 95 percent of ASTM D 698 maximum density (80). • Plastic piping shall have bedding to spring line of pipe. Provide ASTM D 2321 materials as follows (81): <ul style="list-style-type: none"> ➤ Class I: Angular, 0.25 to 1.5 in. graded stone, including a number of fill materials that have regional significance such as coral, slag, cinders, crushed stone, and crushed shells. ➤ Class II: Coarse sands and gravels with maximum particle size of 1.5 in., including various graded sands and gravels containing small percentages of fines, generally granular and noncohesive, either wet or dry. Soil Types GW, GP, SW, and SP are included in this class as specified in ASTM D 2487 (82). • Specify type of bedding or backfill material and show where material is required in the plans. <ul style="list-style-type: none"> ➤ Class II: Coarse sands and gravels with maximum particle size of 1.5 in., including various graded sands and gravels containing small percentages of fines, generally granular and noncohesive, either wet or dry. Soil Types GW, GP, SW, and SP are included in this class as specified in ASTM D 2487 (82). |

Table 29. Summary of Installation Requirements Related to Earthwork (Continued).

| Item | Installation Requirements |
|--|---|
| Pipe bedding and backfill (continued) | <ul style="list-style-type: none"> Specify type of bedding or backfill material and show where material is required in the plans. |
| Pipeline casing | <ul style="list-style-type: none"> Where traffic can be interrupted, UFGS 33 11 00 considers trenching in a pipeline to be more economical with the same advantages of allowing future work without interrupting traffic. Use ASTM A 139/A 139M Grade B, or ASTM A 252 Grade 2 smooth wall pipe for casing. Casing size shall be of the outside diameter and wall thickness as indicated in the plans. Protective coating is not required on casing pipe (83, 84, 85). Mechanically bore holes and case through the soil with a cutting head on a continuous auger mounted inside the casing pipe. Weld lengths of pipe together in accordance with AWS D1.1/D1.1M (86). Do not use water or other fluids in connection with the boring operation. Attach a pipe-cleaning plug to the boring rig and pass it through the pipe to remove dirt, weld splatters, and other foreign matter that would interfere with insertion of the pipe utility. Install pipe utility in casing using wood supports adjusted to obtained grades and elevations indicated. After installation of pipe utility, provide watertight end seals at each end of pipeline casing between casing and pipe utility. |

Table 30. Summary of Installation Requirements for Water Mains.

| Pipe Material | Installation Requirements |
|---------------|--|
| Ductile Iron | <ul style="list-style-type: none"> Unless otherwise specified, install pipe and fittings in accordance with <i>General Requirements for Installation of Pipelines</i> given in UFGS 33 11 00, and with the requirements of AWWA C600 for pipe installation, joint assembly, valve-and-fitting installation, and thrust restraint. The maximum allowable deflection shall be as given in AWWA C600. If the alignment requires deflection in excess of the specified tolerance, special bends, or a sufficient number of shorter lengths of pipe shall be furnished to provide angular deflections within the limit set forth. |

Table 30. Summary of Installation Requirements for Water Mains (Continued).

| Pipe Material | Installation Requirements |
|------------------------------|---|
| Ductile Iron (Continued) | <p>Provide concrete thrust blocks (reaction backing) or a metal harness for pipe anchorage. Thrust blocks shall be in accordance with the requirements of AWWA C600 for thrust restraint, except that size and positioning of thrust blocks shall be as indicated in the plans. Use concrete, ASTM C 94/C 94M, having a minimum compressive strength of 2,500 psi at 28 days; or use concrete of a mix not leaner than one part cement, 2 1/2 parts sand, and 5 parts gravel, having the same minimum compressive strength. Metal harness shall be in accordance with the requirements of AWWA C600 for thrust restraint, using tie rods and clamps as shown in NFPA 24, except as otherwise indicated in the plans (87, 88, 89).</p> <ul style="list-style-type: none"> • When required, completely encase buried ductile iron pipelines with polyethylene tube or sheet, using Class A or Class C polyethylene film, in accordance with AWWA C105/A21.5. |
| PVC | <ul style="list-style-type: none"> • Unless otherwise specified, install pipe and fittings in accordance with <i>General Requirements for Installation of Pipelines</i> given in UFGS 33 11 00; with the requirements of UBPPA UNI-B-3 for laying of pipe, joining PVC pipe to fittings and accessories, and setting of hydrants, valves, and fittings; and with the recommendations for pipe joint assembly and appurtenance installation in AWWA M23, Chapter 7, <i>Installation</i> (90, 6). • Provide concrete thrust blocks (reaction backing) or a metal harness for pipe anchorage. Thrust blocks shall be in accordance with the requirements of UBPPA UNI-B-3 for reaction or thrust blocking and plugging of dead ends, except that size and positioning of thrust blocks shall be as indicated in the plans. Use concrete, ASTM C 94/C 94M, having a minimum compressive strength of 2,500 psi at 28 days; or use concrete of a mix not leaner than one part cement, 2 1/2 parts sand, and 5 parts gravel, having the same minimum compressive strength. Metal harness shall be as indicated in the plans. • Fittings shall be installed in accordance with AWWA C605 (91). |
| PVCO | <ul style="list-style-type: none"> • Install PVCO pressure piping in accordance with AWWA C605 (91). |
| Polyethylene | <ul style="list-style-type: none"> • PE pipes shall be installed in accordance with ASTM D 2774 (92). |
| RTRP-I, RTRP-II, and RPMP | <ul style="list-style-type: none"> • These materials are not used on Navy projects. • RTRP shall be installed in accordance with ASTM D 3839 (93). • RPMP shall be installed in accordance with the manufacturer's recommendations. |

Table 30. Summary of Installation Requirements for Water Mains (Continued).

| Pipe Material | Installation Requirements |
|--------------------------------------|--|
| Reinforced and Pre-Stressed Concrete | <ul style="list-style-type: none"> • Except as otherwise specified, install pipe and fittings in accordance with <i>General Requirements for Installation of Pipelines</i> given in UFGS 33 11 00; with the laying and joining requirements specified in AWWA M9, Chapter 14, <i>Guide Specifications for Installation of Pipe</i>; and with the recommendations given in AWWA M9, Chapter 7, <i>Thrust Restraining Methods</i> (8). • Provide concrete thrust blocks (reaction backing) or a metal harness for pipe anchorage when required. Thrust blocks shall be in accordance with the recommendations of AWWA M9, Chapter 7, <i>Thrust Restraining Methods</i>, except that size and positioning of thrust blocks shall be as indicated. Use concrete, ASTM C94/C94M, having a minimum compressive strength of 2500 psi at 28 days; or use concrete of a mix not leaner than one part cement, 2 1/2 parts sand, and 5 parts gravel, having the same minimum compressive strength. Metal harness shall be in accordance with the recommendations for tied joints in AWWA M9, Chapter 7, <i>Thrust Restraining Methods</i>. |
| Steel | <ul style="list-style-type: none"> • Unless otherwise specified, install pipe and fittings in accordance with AWWA M11, Chapter 12, <i>Transportation, Installation, and Testing</i>. • Welded joints should not be allowed for pipes less than 24 in. in diameter, except when pipeline is to be cement-mortar lined in place after installation. Make welded joints in accordance with AWWA C206 and with the recommendations given for installation of pipe in AWWA M11, Chapter 12, <i>Transportation, Installation, and Testing</i> (94). • Under ordinary conditions, steel pipes come furnished with factory-applied cement-mortar lining. If in-place cement-mortar lining will be done as part of installation, the materials for this lining shall conform to AWWA C602. • Provide concrete thrust blocks or a metal harness for pipe anchorage as required. Thrust blocks shall be in accordance with the recommendations for thrust restraint in AWWA M11, Chapter 13, <i>Supplementary Design Data and Details</i>, except that size and positioning of thrust blocks shall be as indicated. Use concrete, ASTM C 94/C 94M, having a minimum compressive strength of 2500 psi at 28 days, or use concrete of a mix not leaner than one part cement, 2 1/2 parts sand, and 5 parts gravel, having the same minimum compressive strength. Metal harness shall be in accordance with the recommendations for joint harnesses in AWWA M11, Chapter 13, <i>Supplementary Design Data and Details</i>, except as otherwise indicated. Metal harness shall be fabricated by the pipe manufacturer and furnished with the pipe. |

Table 31. Summary of Installation Requirements for Water Service Lines.

| Pipe Material | Installation Requirements |
|-----------------|--|
| Metallic Piping | <ul style="list-style-type: none"> • Install pipe and fittings in accordance with <i>General Requirements for Installation of Pipelines</i> given in UFGS 33 11 00 and with the applicable requirements of AWWA C600 for pipe installation, unless otherwise specified. • Unless otherwise specified, prepare, prime, and coat exterior surface of zinc-coated steel pipe and associated fittings to be buried with hot-applied coal-tar enamel with a bonded single layer of felt wrap in accordance with AWWA C203 or double felt wraps in accordance with AWWA C203. For the felt wrap material, use fibrous-glass mat as specified in AWWA C203; use of asbestos felt is not permitted. Use solvent wash only to remove oil, grease, and other extraneous matter from zinc-coated pipe and fittings. |
| Plastic Piping | <ul style="list-style-type: none"> • Install pipe and fittings in accordance with <i>General Requirements for Installation of Pipelines</i> given in UFGS 33 11 00 and with the applicable requirements of ASTM D 2774 and ASTM D 2855, unless otherwise specified (92, 95). • Handle solvent cements used to join plastic piping in accordance with ASTM F 402 (96). |

Sanitary Sewers

UFGS section 33 30 00 covers requirements for piping and appurtenant structures for an exterior sanitary sewer system (97). UFGS 33 30 00 provides guidelines and specifications on material selection, pipe design, joint selection, and pipe protection from degradation caused by chemical reactions occurring within the operational environment of the buried utility. The guidelines can be categorized as either materials- or design-related, and are summarized in Table 6. Table 7 summarizes the specifications for sanitary sewers according to the material used.

UFGS section 33 30 00 includes a provision for deflection testing of non-pressure plastic pipes upon completion of work adjacent to and over the pipeline, including leakage tests, backfilling, grading, paving, concreting, and any other superimposed loads determined in accordance with ASTM D2412. The section requires that the pipe deflection under external loads be no greater than 4.5 percent of the average inside diameter of the installed pipe. The test is conducted using a pull-through device or a deflection-measuring device.

In the pull-through method, the test device is passed through each run of pipe by either pulling it through or flushing it through with water. If the device fails to pass freely through a pipe run, the contractor is required to replace the pipe showing the excessive deflection. A retest is conducted in the same manner and under the same conditions after replacement of defective pipes.

If a deflection-measuring device is used, the specification requires that the device be sensitive to 1.0 percent of the diameter of the pipe to be tested and accurate to 1.0 percent of the indicated dimension. The deflection-measuring device shall be approved prior to use. In this test, the

contractor measures the deflections through each run of installed pipe. If deflection readings in excess of 4.5 percent of the average inside pipe diameter are obtained, the pipe is retested by running the device along the opposite direction. If the retest continues to show a deflection in excess of 4.5 percent, the contractor is required to replace the pipe showing the excessive deflection. A retest is conducted in the same manner and under the same conditions after replacement of defective pipes.

Natural Gas/Liquid Petroleum Piping

UFGS section 33 11 23 covers requirements for exterior and interior fuel gas piping (98). This guide specification is intended for use when specifying buried polyethylene piping up to 8 in. in nominal diameter, and at pressures and other conditions governed by ASME B31.8 *Gas Transmission and Distribution Piping Systems* (99). The specification stipulates totally PE piping for buried plastic lines. PE pipe is required to conform to ASTM D2513, 100 psig working pressure, with SDR no greater than 11.5 (100).

Excavation and backfilling of pipe trenches are performed in accordance with UFGS section 31 00 00 *Earthwork* (101). PE pipe is placed directly on the trench bottom and covered with a minimum 3 in. of sand to the top of pipe. If the trench bottom is rocky, the pipe is placed on a 3-in. bed of sand and then covered as stated previously. The pipe is buried 24 in. below finished grade or deeper according to the plans. The required compaction is expressed as a percentage of the maximum density obtained using ASTM D1557 unless soil borings indicate a gradation that may include coarse material where more than 30 percent is retained on the 3/4-in. sieve (102). In that case, the required compaction is expressed as a percentage of the maximum density based on AASHTO T180 and corrected with AASHTO T224 (103, 104).

Table 32. Summary of Materials- and Design-Related Guidelines for Sanitary Sewers.

| Category | Pertinent Guidelines |
|-------------------|--|
| Materials-Related | <ul style="list-style-type: none"> • Pipe materials, which are known to be unsuitable for local conditions (i.e., corrosion, root penetration, etc.), should not be permitted for the project. Consider use of more effective protective coatings and jointing methods where economically feasible. • In areas where problems with root penetration are anticipated, specify pipe with joints that will successfully resist root penetration. In general, the more watertight the joint, the greater the resistance to root penetration. For this problem, rubber-gasketed, compression-type, or solvent-cemented joints are preferred. When more than one type of joint is applicable, permit each joint as a contractor’s option except where watertight joints are necessary in areas where root penetration problems are anticipated. Use fuel resistant joint gaskets when required. • For cases where corrosive conditions are expected during service, investigate the materials for resistance to the particular chemicals of concern to the engineer. Corrosion-resistant materials other than those specified herein may be used. |

Table 32. Summary of Materials- and Design-Related Guidelines for Sanitary Sewers (Continued).

| Category | Pertinent Guidelines |
|----------------------------------|---|
| Materials-Related (Continued) | <ul style="list-style-type: none"> • Further information on clay pipe may be found in the Clay Pipe Engineering Manual of the National Clay Pipe Institute (105). Information on the selection of concrete sewer pipe and jointing materials may be obtained from the American Concrete Pipe Association’s Concrete Pipe Design Manual and the Concrete Pipe Handbook (106, 107). For cases where concrete pipe is used, consider chemical requirements for cement when concrete pipe will convey sulfate-bearing waters, or when the pipe will be buried in soil containing sulfates. Use caution if considering concrete pipe for septic flows. Depending on septicity, these pipes may not be satisfactory. • Where required for special applications, reinforced concrete arch pipe conforming to ASTM C 506 or reinforced concrete elliptical pipe conforming to ASTM C 507 may be specified (108, 109). • Plastic pipe is subject to temperature limitations that must be observed when specifying this pipe for service from laundries, kitchens, and other facilities discharging large quantities of water at elevated temperatures. • Do not use ABS pipe for applications where high chemical resistance is required, such as in lines from laboratories or hospitals. |
| Design-Related | <ul style="list-style-type: none"> • Specify equivalent pipe design for the project conditions (using the applicable criteria) for each pipe material insofar as is practicable. American Society of Civil Engineers (ASCE) Manual No. 37 <i>Design and Construction of Sanitary and Storm Sewers</i> contains methods for calculating pipe structural requirements (110). The required strengths for pipes of various materials may be determined from these calculations. • Investigate external loads, including earth, truck, seismic, and impact loads in the design stage of the project. Give special attention in the design stage to plastic pipe materials, particularly with respect to superimposed external loads, which could cause excessive deflection of the pipe. The degree of side fill compaction should be considered realistically, particularly in marginal cases. • For sanitary gravity sewer systems, pipes that may be considered for installation include clay, concrete, ductile-iron, ABS, composite plastic, and PVC. • Sanitary sewer pressure lines may be of ductile iron, concrete, or PVC plastic pressure pipe. • Tables of trench loadings, trench backfill loads, and supporting strengths of clay pipe are included in the Clay Pipe Engineering Manual. The required strength of clay pipe can be derived from these tables when the depth of trench is known. |

Table 32. Summary of Materials- and Design-Related Guidelines for Sanitary Sewers (Continued).

| Category | Pertinent Guidelines |
|-------------------------------|---|
| Design-Related (Continued) | <ul style="list-style-type: none"> • For concrete gravity sewer pipes, the load per linear foot of pipe diameter must be calculated on the basis of project conditions to determine the applicable class or strength of pipe. The Concrete Pipe Design Manual contains design information and methods by which the applicable class or strength of pipe can be determined when the depth of trench is known. • For concrete pressure sewer pipes, ASTM C 361M/C 361 covers pipe for up to 125 ft of hydrostatic head (approximately 55 psi) (111, 112). AWWA C302 covers pipe and fittings for 45 psi pressure rating (100 ft of hydrostatic head) (113). ASTM C 361M/C 361 contains tables giving design requirements for pipes in all combinations of 100 and 125 ft of hydrostatic head with 5, 10, 15, and 20 ft of earth cover. Where higher pressure ratings are necessary, pipes conforming to AWWA C300, C301, or C303 should be specified. • ASTM A 746 contains design information and methods by which the required thickness class of ductile-iron gravity pipe can be determined when the depth of trench is known (114). |

Table 33. Summary of Requirements for Sanitary Sewers.

| Pipe Material | Design/Material Requirements |
|---------------|---|
| Concrete | <ul style="list-style-type: none"> • Cement mortar shall conform to ASTM C 270, Type M with Type II cement (115). Type II cement normally will be specified when water-soluble sulfates in the soil are in the range of 0.1 to 0.2 percent, or 150 to 1000 ppm in water. Type V cement will be specified when the soil contains in excess of 0.2 percent water-soluble sulfates, or the wastewater contains sulfates in excess of 1000 ppm. Type I cement may be permitted when water-soluble sulfates in the soil will be less than 0.1 percent, and the wastewater will contain less than 150 ppm over the project's design life. • The contractor shall submit certificates of compliance stating the type of cement used in the manufacture of concrete pipe, fittings, and precast manholes. Portland cement shall conform to ASTM C 150/C 150M, Type II or V for concrete used in concrete pipe, concrete pipe fittings, and manholes (116, 117). Cement type is optional with the contractor for cement used in concrete cradle, concrete encasement, and thrust blocking. Air-entraining admixture conforming to ASTM C 260 shall be used with Type V cement (118). Where aggregates are alkali reactive, as determined by Appendix XI of ASTM C 33/C 33M, cement containing less than 0.60 percent alkalis shall be used (119, 120). |

Table 33. Summary of Requirements for Sanitary Sewers (Continued).

| Pipe Material | Design/Material Requirements |
|-------------------------|---|
| Concrete (Continued) | <ul style="list-style-type: none"> • For projects where concrete is mixed onsite, specify concrete aggregates conforming to ASTM C 33/C 33M and concrete consisting of 1 part Portland cement, 2-1/2 parts sand, and 5 parts gravel, with just enough water for workable consistency. Portland cement concrete shall conform to ASTM C 94/C 94M, compressive strength of 4000 psi at 28 days, except for concrete cradle and encasement, or concrete blocks for manholes. Concrete used for cradle and encasement shall have a compressive strength of 2500 psi minimum at 28 days. Concrete in place shall be protected from freezing and moisture loss for 7 days. • Concrete gravity sewer pipes shall be either non-reinforced conforming to ASTM C 14M or ASTM C 14, or reinforced conforming to ASTM C 76M or ASTM C 76 of class as specified in the plans (121, 122, 123, 124). Cement used in manufacturing pipe and fittings shall be Type II, Type V, or low alkali cement conforming to ASTM C 150/C 150M. Concrete pressure sewer pipes shall conform to AWWA C302 or to ASTM C361M/C361. Pipe shall be designed for hydrostatic head of 100 or 125 ft and external loading of 5, 10, 15, or 20 ft of earth cover. Cement used in manufacturing pipe and fittings shall be Type II, Type V, or low alkali cement conforming to ASTM C150/C150M. Fittings shall conform to AWWA C302. • Circular concrete pipes with elliptical reinforcement shall have a readily visible line at least 12 in. long painted or otherwise applied on the inside and outside of the pipe at each end so that when the pipe is laid in the proper position, the line will be at the center of the top of the pipe. Fittings and specials shall conform to the applicable requirements specified for the pipe and shall be of the same strength as the pipe. |
| Ductile Iron | <ul style="list-style-type: none"> • Ductile iron pipes for gravity sewer systems shall conform to ASTM A 746 with the thickness class specified in the plans. Fittings shall have strength at least equivalent to that of the pipe. • Ductile iron pressure pipe is used in sizes ranging from 3 to 64 in. Use thickness class 52 for Atlantic Division, Naval Facilities Engineering Command projects. Ductile-iron pipe shall conform to AWWA C151/A21.51, of the thickness class specified in the plans. Flanged pipe shall conform to AWWA C115/A21.15. Fittings shall have a pressure rating at least equivalent to that of the pipe (125). • Fittings shall conform to AWWA C110/A21.10 or AWWA C153/A21.53. Fittings with push-on joint ends shall conform to the same requirements as fittings with mechanical-joint ends, except that the bell design shall be modified as approved by the Contracting Officer, for push-on joint. Ends of pipe and fittings shall be suitable for the joints specified. Pipe and fittings shall have cement-mortar lining conforming to AWWA C104/A21.4, standard thickness. |
| ABS | <ul style="list-style-type: none"> • Use ASTM D 2680 for ABS composite plastic pipe and fittings (126). |

Table 33. Summary of Requirements for Sanitary Sewers (Continued).

| Pipe Material | Design/Material Requirements |
|-----------------|---|
| ABS (Continued) | <ul style="list-style-type: none"> • Use ASTM D 2751, SDR 35 with ends suitable for either solvent cement joints or elastomeric joints for ABS solid-wall plastic piping (127). Solvent cement for solvent cement joints shall conform to ASTM D 2235. Elastomeric joints shall conform to ASTM D 3212, and the gaskets for these joints shall conform to ASTM F 477 (128, 129). |
| PVC | <ul style="list-style-type: none"> • For gravity sewer systems, use ASTM D 3034, SDR 35, or ASTM F 949 with ends suitable for elastomeric gasket joints (25, 130). Use ASTM F 794, Series 46, for ribbed sewer pipe with smooth interior, size 8- through 48-in. diameters (131). • For pressure sewer systems, PVC plastic pipes and fittings less than 4 in. in diameter shall be manufactured of materials conforming to ASTM D 1784, Class 12454B (132). Pipes 4 to 12 in. in diameter shall conform to AWWA C900 and shall be plain end or gasket bell end, pressure class 150 (DR 18), with cast-iron-pipe equivalent OD. Fittings shall be gray-iron or ductile-iron conforming to AWWA C110/A21.10 or AWWA C153/A21.53 and shall have cement-mortar lining conforming to AWWA C104/A21.4, standard thickness (133). Fittings with push-on joint ends shall conform to the same requirements as fittings with mechanical-joint ends, except that bell design shall be modified as approved, for push-on joint suitable for use with the specified PVC plastic pressure pipe. |
| HDPE | <ul style="list-style-type: none"> • ASTM F 894, Class 63, for 18- through 120-in. pipe sizes (134). • ASTM F 714, for 4- through 48-in. sizes (135). The polyethylene shall be certified by the resin producer as meeting the requirements of ASTM D 3350, cell Class 334433C (136). The pipe stiffness shall be greater than or equal to 1170/D for cohesionless material pipe trench backfills. |
| RPMP | <ul style="list-style-type: none"> • Pipe shall be produced in accordance with ASTM D 3262 and shall have an outside diameter equal to ductile iron pipe dimensions from 18-in. to 48-in. (137). The inner surface of the pipe shall have a smooth uniform continuous resin-rich surface liner. The minimum pipe stiffness shall be 36 psi. |
| RTRP | <ul style="list-style-type: none"> • Use ASTM D 3262. Filament wound RTRP-I pipe shall conform to ASTM D 2996, except that the pipe shall have an outside diameter equal to cast iron outside diameter or standard weight steel pipe. The pipe shall be suitable for a normal working pressure of 150 psi at 73°F. The inner surface of the pipe shall have a smooth uniform continuous resin-rich surface liner conforming to ASTM D 2996. Centrifugally cast RTRP-II pipe shall conform to ASTM D 2997. Pipe shall have an outside diameter equal to standard weight steel pipe. |

CHAPTER 3. DESIGN REQUIREMENTS FOR UNDERGROUND UTILITY STRUCTURES IN THE TEXAS UTILITY ACCOMMODATION RULES

INTRODUCTION

The installation of underground utilities within state right of way is subject to a range of federal, statewide, and industry-specific regulations or rules. The UAR specify that the design of any utility installation, adjustment, or relocation on the state right of way is the responsibility of utility owners and needs to meet a standard acceptable to TxDOT (138). Longitudinal utility installations on right of way are generally not allowed beneath any pavement including shoulders, in the center median, and in the outer separation if frontage roads exist. In the current UAR, rule §21.40 (Underground Utilities) contains installation specifications pertaining to all types of underground utility facilities allowed on state right of way. Examples of other regulations applicable to underground utility facilities within state right of way include (138):

- National Electrical Safety Code (139).
- Title 49 of the Code of Federal Regulations Part 192, *Transportation of Natural and Other Gas by Pipeline: Minimum Federal Safety Standards* (140).
- Title 49 of the Code of Federal Regulations Part 195, *Transportation of Hazardous Liquids by Pipeline* (141).
- The latest American Society for Testing and Materials (ASTM) specifications.
- Title 30 of the Texas Administrative Code, Sections 290.38 – 290.47, relating to Rules and Regulations for Public Water Systems (142).

CURRENT UTILITY ACCOMMODATION RULES

The current version of the UAR is a result of years of rule evolution. The origin of the state utility accommodation policy can be traced to a number of documents that provided early guidelines for the installation of underground utility facilities in the late 1940s and early 1950s. The development of these early specifications was likely subject to county and district engineer opinion and experience, personal bias, and engineering judgment. Examples of documents used by TxDOT, which at the time was called the Texas Highway Department, include the following (143):

- **Texas Transportation Commission Minute 23630 of August 1, 1947.** This Commission Minute provided general rules and regulations governing the handling of requests for placements of pole lines or pipelines on state right of way.
- **Administrative Circular 62-49 of November 29, 1949.** This Administrative Circular permitted single-pole power lines and applicable water transmission lines on state right of way.
- **Administrative Order 17-55 of April 19, 1955.** This Administrative Order outlined the construction procedures to be followed when placing pipelines on state right of way.

- **Administrative Order 12-56 of May 10, 1956.** This Administrative Order included encasement requirements for rural pipeline crossings of expressways, U.S. and state highways, and farm roads.
- **Administrative Circular 16-56 of June 26, 1956.** This Administrative Circular legalized the rights of several types of public utilities, including telegraph, telephone, water, sewer, gas, oil, and salt brine lines, to occupy highway right of way.

Over time, more research and national guidance became available that influenced the process of creating or modifying rules for the accommodation of buried utilities in the right of way. The following major documents contributed significantly to the development and evolution of the UAR in its current version:

- **Title 23 of the Code of Federal Regulations Part 645B, Accommodation of Utilities (144).** This part of the Code of Federal Regulations describes general policies and procedures for accommodating utility facilities on the right of way of federal-aid or direct federal highway projects. It includes general requirements on the contents and standards of utility accommodation policies of state transportation agencies. However, the code does not contain technical specification requirements on the design and installation of utility facilities.
- **A Policy on the Accommodation of Utilities within Freeway Right of Way (145).** The policy was first adopted by the Bureau of Public Roads, the agency preceding the FHWA, as a design standard for Interstate projects. This policy was later expanded to cover all access-controlled freeways regardless of system and has values for partially access-controlled highways. The latest version of this policy was published in 2005. The policy was intended to promote uniformity of utility treatment among states while ensuring that highway safety and operations are not negatively impacted. It does not contain detailed specifications regarding the installation and protection of buried utility facilities.
- **A Guide for Accommodating Utilities within Highway Right of Way (146).** The guide was first adopted by the Bureau of Public Roads in 1969, and the current version was published in 2005. This document provides a set of general guidelines to assist states in establishing and administering reasonably uniform policies for utility facilities within highway right of way. For underground facilities, for instance, the document provides guidelines for establishing specifications from aspects such as location, highway structure attachments, cover, separation, encasement, and construction.
- **Highway/Utility Guide (147).** The guide is a comprehensive document reviewing policies, procedures, and practices related to right of way utilities, especially the coordination practices between highway and utility agencies. The document was intended to be a general guide to assist state and local agencies in developing utility-related manuals and policies. As such, it does not include detailed specifications pertaining to underground utility facilities.

With the passage of the Administrative Procedure and Texas Register Act in 1975, state agency rule writers began the organization and systematic dissemination of state agency rules (148). In 1977, Texas Legislature directed the Office of the Secretary of State to compile, index, and cause to be published the Texas Administrative Code under the Administrative Code Act. The rules of the then State Department of Highways and Public Transportation (SDHPT) were organized into sections and subsections, with 32 rules under Utility Accommodation of the Right of Way Division (149).

In October 1979, the Texas Administrative Code was reorganized into titles and chapters, and the format has been generally followed since then (150). During this reorganization, the previous Transportation section became Title 43, and the Right of Way Division subsection became Chapter 21. In addition, the utility accommodation rules were renumbered, and several were combined, as shown in Table 34. The rules, particularly those pertaining to underground utility facilities, underwent two comprehensive revisions and reorganizations in 1989 and 2005, and several additional rounds of less comprehensive revisions. Table 34 provides an overview of the rule numbering before and after the Texas Administrative Code was revised and reorganized in 1979.

Table 34. Numbering of Utility Accommodation Rules Before and After Revision and Reorganization of the Texas Administrative Code in 1979.

| Before 1979 Revision | After 1979 Revision |
|--|---|
| .001 Utilities | §21.31 Definitions |
| .002 Low Volume Highways and Low Volume Farm to Market Roads | Combined into §21.31 |
| .003 High and Low Pressure Gas Lines | |
| .004 Clear Roadside Policy | |
| .005 Pavement Structure | |
| .006 Active Project | |
| .007 District Engineer | |
| .008 Department | |
| .015 Purpose | §21.32 Purpose |
| .016 Application | §21.33 Application |
| .017 Scope | §21.34 Scope |
| .018 Exceptions | §21.35 Exceptions |
| .019 Authority of Utilities | §21.36 Authority of Utilities |
| .025 Location | §21.37 Location |
| .026 Design | §21.38 Design |
| .027 Aesthetics | §21.39 Aesthetics |
| .028 Safety | §21.40 Safety |
| .029 Miscellaneous | §21.41 Miscellaneous |
| .030 Pipelines – General | §21.42 Pipelines – General |
| .031 High Pressure Gas and Liquid Petroleum Lines | §21.43 High Pressure Gas and Liquid Petroleum Lines |
| .032 Low Pressure Gas Lines | §21.44 Low Pressure Gas Lines |
| .033 Water Lines | §21.45 Water Lines |
| .034 Sanitary Sewer Lines | §21.46 Sanitary Sewer Lines |
| .040 Utility Structures | §21.47 Utility Structures |
| .041 Traffic Structures | §21.48 Traffic Structures |
| .045 Overhead Power and Communication Lines | §21.49 Overhead Power and Communication Lines |
| .050 Underground Power Lines | §21.50 Underground Power Lines |
| .055 Underground Communication Lines | §21.51 Underground Communication Lines |
| .060 Forms – General | §21.52 Forms – General |
| .061 Use and Occupancy Agreement Forms | §21.53 Use and Occupancy Agreement Forms |
| .062 Notice Forms | §21.54 Notice Forms |
| .063 Abandoned Interests | §21.55 Abandoned Interests |

SUMMARY OF CHANGES TO UTILITY ACCOMMODATION RULES SINCE 1979

Since the reorganization of the Texas Administrative Code in 1979, the UAR have been amended or otherwise modified 11 times, on average about every three years. Some of the UAR updates have been small in scope, other updates have been more substantial. The first comprehensive revision of the UAR was in 1989 followed by a major revision in 2005 and further amendments in 2008 and 2009. Table 35 provides an overview of these changes since the beginning of the new rule structure in 1979 and indicates which sections of the UAR underwent minor or major changes, including amendments, rule additions, rule repeal, and rule repeal and replacement. The following provides a summary of the specific changes to the UAR for the year when the new rules went into effect.

Adopted Changes in 1982 (151)

The department amended rule §21.48 (Traffic Structures) in relation to the permissive attachment of utility lines to highway bridges at no cost to the state and payment of rental fees. These changes did not affect underground utility facilities.

Adopted Changes in 1989 (152)

The department officially adopted major amendments to rules §§21.31 – 32, 21.35, 21.37 – 40, 21.42 – 46, 21.48 – 51, and 21.53 – 54, and new (i.e., replaced the previous) rules §§21.33 and 21.41, to improve safety, avoid unnecessary utility adjustment and installation delays, and reflect changes in methods and technology of the highway and utility industries. The amendments and new rules were adopted temporarily in December 1988 on an emergency basis. This was the first comprehensive revision of the rules since they were recompiled in 1979.

- **Rule §21.31: Definitions.** The changes to this rule included insertion of new definitions and expansion of several previous terms. The modifications were necessary due to the amendments to the following rules.
- **Rule §21.32: Purpose.** New statements were added in the rule to further emphasize the safety and protection of highways in consideration for utility installations.
- **Rule §21.33: Application.** The new rule defined that the utility accommodation rules applied to new utility installations, additions to existing installations, adjustments or relocations of utilities incident to highway construction, and existing utility installations for which applicable waivers might be authorized.
- **Rule §21.35: Exceptions.** This rule was amended to allow persons other than the State Engineer-Director to approve exceptions.
- **Rule §21.37: Location.** The rule was amended by inserting new provisions for longitudinal utility installations.

Table 35. Historical Modifications to Utility Accommodation Rules after 1979.

| Year ^a | Utility Accommodation Rule | | | | | | | | | | | | | | | | | | | | | | | | | | | |
|-------------------|----------------------------|-------|-------|-------|-------|-------|-------|-------|-------|-------|-------|-------|-------|-------|-------|-------|-------|-------|-------|-------|-------|-------|-------|-------|-------|-------|---|---|
| | 21.31 | 21.32 | 21.33 | 21.34 | 21.35 | 21.36 | 21.37 | 21.38 | 21.39 | 21.40 | 21.41 | 21.42 | 21.43 | 21.44 | 21.45 | 21.46 | 21.47 | 21.48 | 21.49 | 21.50 | 21.51 | 21.52 | 21.53 | 21.54 | 21.55 | 21.56 | | |
| 1979 | | | | | | | | | | | | | | | | | | | | | | | | | | | | |
| 1982 | | | | | | | | | | | | | | | | | | | A | | | | | | | | | |
| 1989 ^b | A | A | R | | A | | A | A | A | A | R | A | A | A | A | A | | A | A | A | A | | | | | | | |
| 1990 | | | A | | | | | | | | | | | | | | | | | | | | | | | | | |
| 1996 | | | | | | | | | | | | | | | | | | | | | | | | | | N | | |
| 1997 | | | | | A | | | | | | | | | | | | | | | | | | | | | | | |
| 1998 | | | | | | | | | | | | | | | | | | | | | | | | | | A | | |
| 1999 | | | | | A | | | | | | | | | | | | | | | | | | | | | | | |
| 2001 | A | | c | c | | | | | | | | | | | | | | | c | | c | c | c | c | c | | | |
| 2005 ^c | R | R | R | R | R | R | R | R | R | R | R | X | X | X | X | X | X | X | X | X | X | | | | | | | |
| 2008 | A | | | | c | | c | c | A | c | | | | | | | | | | | | | | | c | A | A | c |
| 2009 | A | | A | c | | A | c | | | | | | N | | | | | | | | | | | | | | | |

c: Minor change (mainly grammatical changes to improve clarity).

A: Major amendment (such as change to title, insertion of new provisions, and significant changes to existing provisions).

N: New rule added.

R: Rule repealed and replaced.

X: Rule repealed (no replacement).

^a Year of rule adoption, excluding the temporary adoptions of amendments or new rules on an emergency basis.

^b Most rules pertaining to underground utility facilities were amended, including changes to the requirements on depth of cover, encasement, and manholes.

^c Rule §21.40 (Underground Utilities) newly adopted with installation specifications on all types of underground utility facilities. All provisions remain in use today with minor changes.

- **Rule §21.38: Design.** The amended rule included a number of new references. In addition, it inserted a new specification on clearances between underground utilities and sewers, and new general design requirements for manholes previously included separately for individual utilities.
- **Rule §21.39: Aesthetics.** The amended rule had more specific requirements on tree replacement and tree value.
- **Rule §21.40: Safety.** The rule was amended to include requirements on proper signs, markers, and barricades during utility constructions on right of way.
- **Rule §21.41: Site Clean Up.** The department repealed and replaced the existing rule (§21.41: Miscellaneous). The new rule included additional provisions to require right of way to be restored to the original or better condition after utility installations.
- **Rule §21.42: Pipelines – General.** The amended rule included new provisions to regulate boring operations on state right of way. The new requirements included:
 - For rural highway crossings, all borings needed to extend beneath travel lanes plus 30 ft from freeway mainlanes and other high-speed, high-volume roads, 16 ft from high-speed, low-volume highways and ramps, or 10 ft from low-speed roads.
 - For urban highway crossings, all borings needed to extend beneath travel and parking lanes and extend beyond the back of curb plus 30 ft from high-speed facilities and 3 ft from low-speed facilities plus any additional width to clear an existing sidewalk.
 - Additional protection measures such as the use of a fence if these clearances could not be met.
- **Rule §21.43: High Pressure Gas and Liquid Petroleum Lines.** The amendment clarified the requirements on depth of cover and included new requirement on markers and aboveground appurtenances associated with high-pressure gas and liquid petroleum lines.
- **Rule §21.44: Low Pressure Gas Lines.** The major modifications included the clarification of the requirements on depth of cover to include longitudinal lines, new requirements on markers, and new requirement prohibiting aboveground appurtenances. The department also changed the maximum size of plastic lines for crossings from 6 to 24 in. and that of longitudinal lines, which was previously not specified separately, remained 6 in.
- **Rule §21.45: Water Lines.** The rule was amended to specify the rural standard of roadway center median width (76 ft).

- **Rule §21.46: Sanitary Sewer Lines.** The amended rule changed the required material for sanitary sewer lines from cast iron to ductile iron and had several other relatively minor modifications on the provisions pertaining to material and manholes.
- **Rule §21.48: Traffic Structures.** The rule was amended to renumber some existing provisions and to add procedures for applications for attachment to structures.
- **Rule §21.49: Overhead Power and Communications Lines.** The amendment was to include minimum vertical clearances for cable television lines and to revise horizontal clearances for poles and guys.
- **Rule §21.50: Underground Power Lines.** The amended rule had new requirements regarding depth of cover, encasement, crossings, markers, and manholes. The major new requirements were:
 - Longitudinal power lines might be unencased and the minimum depth of cover should be 30 in. for lines with a voltage of 22,000 or less, 36 in. for lines with a voltage between 22,001 and 40,000, and 42 in. for lines with a voltage of 40,001 or greater.
 - Crossings should be encased, and the minimum depth was 48 in. under ditches or 72 in. below pavement surface.
 - Requirements on manholes were the same as the general requirements in Rule §21.38: Design.
- **Rule §21.51: Underground Communication Lines.** The major changes to this rule included the following:
 - More specific requirements on depths of cover. The new rule specified that the minimum depth cable television and copper cable communications lines was 24 in. for longitudinal installations, and 24 in. under ditches or 18 in. beneath the bottom of the pavement structure, whichever is greater, for crossings. The minimum depth for a fiber-optic facility was 42 in. if installed longitudinally, and 42 in. below the ditch grade or 60 in. below the top of the pavement structure, whichever is greater, for crossings.
 - Requirements on manholes changed to the same as the general requirements in rule §21.38: Design.
 - Addition of requirements on large equipment housings on right of way.
 - Additional requirements on markers, placement of the lines, and manholes.

- **Rule §21.53: Use and Occupancy Agreement Forms.** The amended rule changed its title from *Use of Occupancy Agreement Forms* and inserted a new requirement on contents of occupancy agreement forms.
- **Rule §21.54: Notice Forms.** The rule was amended to include a new requirement on the contents of notice forms.

Adopted Changes in 1990 (153)

The department amended rule §21.33 (Application) to secure approval of highway plans from FHWA on projects that involve federal-aid and direct federal projects.

Adopted Changes in 1996 (154)

TxDOT added rule §21.56 (Metric Equivalents) to enable the use of the metric system in its business and project development processes concerning utility accommodation. The new rule required utility companies to use metric measurements when submitting requests for utility accommodations starting October 1, 1996.

Adopted Changes in 1997 (155)

Previously, exceptions to UAR could be authorized by the bridge engineer, chief engineer of highway design, or chief engineer of maintenance and operations. In 1997, TxDOT amended rule §21.35 (Exceptions) to place the authority for approving all exceptions with the Right of Way Division Director.

Adopted Changes in 1998 (156)

TxDOT amended rule §21.56 (Metric Equivalents) to eliminate the mandatory use of metric units in utility accommodation requests as a result of an FHWA statement that the use of metric units was at the option of individual states.

Adopted Changes in 1999 (157)

In 1999, TxDOT amended rule §21.35 (Exceptions) to place the authority of approving requests for exceptions with the Maintenance Division Director instead of the previously Director of the Right of Way Division.

Adopted Changes in 2001 (158)

TxDOT amended rules §§21.31, 21.43 – 44, 21.48, and 21.50 – 21.54. Amendments to most of the rules were relatively minor and are grammatical in nature.

- **Rule §21.31: Definitions.** The amended rule deleted several definitions relevant to manager titles that are no longer used by TxDOT, such as bridge engineer, chief engineer of highway design, and chief engineer of maintenance and operations. The new rule also included grammatical changes to some other definitions.

- **Rules §§21.43, 21.44, 21.48, and 21.50 – 21.54.** The amended rules included minor grammatical changes, such as the use of *right of way* and *that* instead of previously *right of way* and *which*, respectively, and the deletion of the term *State Department of Highways and Public Transportation* or *SDHPT*.

Adopted Changes in 2005 (159)

In 2005, TxDOT repealed the rules §§21.31 – 21.51 and adopted new rules §§21.31 – 21.41. This significant amendment was intended to reorganize the rules for clarity, enable the use of updated utility construction methods and materials, and improve right of way management by requiring better plans and record drawings for utility installations.

- **Rule §21.31: Definitions.** The new rule abandoned most of the previous terms and redefined the rest for clarity. In addition, the new rule included several new terms pertaining to new utility procedures and processes, job functions, and occupational and departmental titles.
- **Rule §21.32: Purpose.** The new rule redefined the purpose of the Utility Accommodation subchapter for clarity.
- **Rule §21.33: Applicability.** The new rule changed its previous title (Application) and contained more detailed provisions defining the applicability of the rules.
- **Rule §21.34: Scope.** The scope was redefined in the new rule to specify the matters it governed; the superiority of other laws, codes, regulations, rules, or orders that had stricter requirements; detailing of district supplemental requirements; and general utility appealing process.
- **Rule §21.35: Exceptions.** The new rule redefined the requirements for requesting and criteria for considering an exception to the provisions of UAR.
- **Rule §21.36: Rights of Utilities.** The new rule changed its previous title (Authority of Utilities) and clarified some of the existing provisions.
- **Rule §21.37: Design.** The new rule replaced the previous rule §21.37 (Location) and included the design requirements for utility installations. In addition to the location requirements on right of way utility installations, it also included requirements regarding the submission of plans, the design of utility tunnels and bridges, the joint use of highway and utility structures, and relevant aesthetic features.
- **Rule §21.38: Construction and Maintenance.** The new rule replaced the previous rule §21.38 (Design) and included standards and requirements for the construction and maintenance of utility lines on state right of way.
- **Rule §21.39: Ownership/Abandonment/Idling.** The new rule replaced the previous rule §21.39(Aesthetics) and included requirements pertaining to property interests of

relocated utility facilities, abandoned utility facilities, and idling facilities on state right of way.

- **Rule §21.40: Underground Utilities.** The new rule replaced the previous rule §21.40 (Safety) and included the provisions previously in several individual rules for the installation of various types of underground utilities on right of way. The new rule had new and expanded requirements for standards pertaining to materials, conditions under which underground utilities may be placed on the right of way, multiple conduits, abandonment, location and placement, and markers organized into the following sections:
 - General requirements.
 - Gas and liquid petroleum lines.
 - Nonpotable water control facilities.
 - Sanitary sewer lines.
 - Electric and communication lines.

With a few minor grammatical changes in 2008, the major specifications on underground utility facility installation included in this rule have remained unchanged.

- **Rule §21.41: Overhead Electric and Communication Lines.** This new rule replaced the previous rule §21.41 (Site Clean-up) and included requirements for the installation, maintenance, and relocation of overhead power and communication lines on state right of way.
- **Rules §§21.42 – 51.** These rules were repealed but not replaced.

Adopted Changes in 2008 (160)

TxDOT amended rules §§21.33, 21.35, 21.37 – 21.40, and 21.52 – 21.55. The amendments were intended to improve clarity of existing language, consistency between federal and state regulations, reflection of current practice, and implementation of the intent of the rules.

- **Rule §21.31: Definitions.** This amended rule contained changes to several definitions and inserted two new definitions (i.e., *joint use agreement* and *use and occupancy agreement*). None of these changes were directly related to the installation specifications.
- **Rule §21.35: Exceptions.** The amended rule had a few minor modifications on the text of the exceptions, none of which directly affect the installation specifications.
- **Rule §21.37: Design.** The amended rule included minor modifications to some text, but none of the modifications directly pertained to the installation specifications.
- **Rule §21.38: Construction and Maintenance.** The amended rule used the term *use and occupancy agreement* instead of the previous *Utility Joint Use Acknowledgement or*

Utility Installation Request. The change was not directly related to the installation specifications.

- **Rule §21.39: Ownership, Function, Abandonment, and Idling of Facilities.** The amended rule changed the previous rule title (Ownership/Abandonment/Idling), deleted the general provision, inserted a provision on change of utility function and additional text on the procedures/requirements pertaining to change of ownership and abandonment or idling of facility, and made minor modifications to some other existing provisions.
- **Rule §21.40: Underground Utilities.** The amended rule included three minor changes to the rule text to improve clarity. Most of the changes are grammatical in nature.
- **Rule §21.52: Forms – General.** The amended rule contained a few minor changes in text including the use of *right(s) of way* instead of *right(s)-of-way*. Those changes were not directly related to the installation specifications.
- **Rule §21.53: Joint Use Agreement Forms.** The previous title of this rule was *Use and Occupancy Agreement Forms*. In addition to changing its title, the amended rule contained changes to all clauses in the rule, many of which were grammatical.
- **Rule §21.54: Use and Occupancy Agreement Forms.** The previous title of this rule was *Notice Forms*. The amended rule had several changes to a number of provisions including two newly inserted clauses pertaining to the use and occupancy agreement forms.
- **Rule §21.55: Abandoned Interests.** The amended rule changed all instances of *right(s)-of-way* to *right(s) of way*. The change was not related to installation specifications for the buried utility facilities.

Adopted Changes in 2009

TxDOT adopted new rule §21.42 in September of 2009 (161) and amendments to rules §§21.31, 21.33 – 34, and 21.36 – 37 in December of 2009 (162). The major purpose of these amendments was to clarify existing language and change some provisions to comply with House Bill 2572, 81st Legislature, Regular Session, 2009 (81(R) HB 2572). The Bill amended Utilities Code §181.005 and authorized gas corporations to lay and maintain gas pipelines along public roads, subject to relevant Railroad Commission of Texas safety regulations, state and federal regulations, and limitations on state reimbursement for the cost of pipeline relocations caused by highway improvement projects.

- **Rule §21.31: Definition.** The proposed amendment contained changes to several definitions including three newly inserted terms and their definitions (i.e., *director*, *engineering study*, and *traffic impact analysis*).

- **Rule §21.33: Applicability.** The proposed amendment contained changes requiring district engineers to detail any supplemental accommodation requirements in writing when they are stricter than the minimum requirements in UAR.
- **Rule §21.34: Scope.** The proposed rule had minor modifications to the scope description for better clarity.
- **Rule §21.36: Rights of Utilities.** The proposed amendment made minor modifications to the existing provisions defining the rights of utilities to occupy state right of way. It also included additional requirements related to requests of new utility facility installations.
- **Rule §21.37: Design.** The proposed amendment expanded the procedures and requirements on longitudinal installations proposed with existing access denial lines of a controlled access highway without frontage roads and included minor modifications on other provisions. None of the modifications is directly related to installation specifications for buried utility facilities.
- **Rule §21.42: Appeal Process.** This is a new rule that was proposed to be added to the current UAR. The rule will provide procedures and requirements for utilities to file a petition of appeal to contest a supplemental accommodation requirement and the denial of the utility's request for a utility installation/adjustment or an exception to any UAR provisions.

Appendix A provides a comparison between installation specifications for underground utility facilities in the 1979 and the most recent, 2010 version of the UAR (138, 145). As shown in the comparison, most of the rules pertaining to underground utility facilities were reorganized and clarified. The new rules in general have stricter requirements on encasement and casing materials. In addition, there are some stricter or new requirements partly in response to new materials and installation techniques. Nevertheless, many technical requirements on aspects such as encasement and minimum depths of cover remained the same. The research team also noticed conflicting requirements in certain sections, including the specifications on the minimum depth of cover for electric lines. Below are the major changes of the requirements pertinent to this research:

- **New requirements associated with new materials and new installation methods.** The current rule specifies in the general encasement requirement that HDPE must be used if horizontal directional drilling is used to place the casing, which was not included in the original version. In addition, it included new minimum depth of cover requirements for underground fiber-optic communication lines due to the increasingly popular use of the material as communication lines. The required minimum depth of cover for all conditions is generally stricter than the minimum for traditional copper lines.
- **Increases of minimum depth of cover.** The current rule included stricter requirements of minimum depth of cover for the following types of underground utility facilities:

- Low-pressure gas and liquid petroleum. The required minimum depth of cover for lines outside pavement was increased from the general 24-in. requirement to 48 in. for unencased lines, 30 in. for unencased sections of encased lines, or 36 in. for longitudinal lines, which became consistent with those for high-pressure gas and liquid petroleum lines.
- Water lines, non-potable water control facilities, and sanitary sewer lines. The required minimum depth of cover increased from 24 in. to 30 in. for lines outside the pavement structure.
- Electric lines. The original rule used the same requirements as those for encased high-pressure gas and liquid petroleum lines (30 in. for the encased portion and 36 in. for the unencased portion). The current rule adopted the requirements in the National Electrical Safety Code, which requires a deeper depth of cover (i.e., 42 in.) for lines of which voltage is higher than 40,000 volts.
- **Encasement Requirements.** The requirements for encasement have changed as follows:
 - General Required Material. Utility lines crossing a highway must be encased in steel, concrete, or plastic pipes, and the strength of the encasement material must equal or exceed structural requirements for drainage culverts.
 - General Length of Encasement. Encasement must be provided as follows:
 - Cut sections: from the top of backslope to top of backslope.
 - Fill sections: 5 ft beyond the toe of slope.
 - Curb sections: 5 ft beyond the face of the curb.
 - Water Lines. Water lines crossing paved highways must be encased in steel encasement within the limits of the right of way. Encasement may be omitted under center medians, outer separations, and side road entrances. Existing unencased water lines may remain unencased if buried 24 in. or deeper under the pavement of new low volume highways.
 - Non-Potable Water Control Facilities. Non-potable water control lines crossing paved highways must be encased in steel encasement within the limits of the right of way, unless the district approves another type of encasement. Encasement may be omitted under center medians, outer separations, and side road entrances.
 - Sanitary Sewer Lines. Sanitary sewer lines crossing paved highways must be encased in steel encasement within the limits of the right of way. Gravity flow lines not conforming to the minimum depth of cover must be encased in steel or concrete. Encasement may be omitted under center medians, outer separations, and side road entrances.

RELEVANT SPECIAL PROVISIONS AT TXDOT DISTRICTS

In addition to UAR, many TxDOT districts have special provisions that provide supplemental requirements for utility accommodation and utility facility relocation. Many of these special provisions include specifications related to underground utility facilities, some of which are stricter than UAR. The following is a summary of the stricter specifications applicable to underground utility facilities at a sample of districts.

Special Provisions for Underground Utility Facilities at the San Antonio District

The current special provisions in the San Antonio District require a stricter minimum depth of cover for the following utility facilities mainly to avoid conflicts with traffic sign foundations (163):

- **Low or high-pressure natural gas and liquid petroleum products:** 60 in. if crossing pavement or parallel less than 10 ft from pavement edge and 48 in. otherwise. UAR requires the same depth for unencased crossing lines while a lesser depth for encased crossing lines and longitudinal installations.
- **Copper telephone cables and TV cables:** 60 in. if crossing pavement or parallel less than 10 ft from pavement edge and 24 in. otherwise. UAR requires 24 in. under ditches or 18 in. beneath the bottom of the pavement structure, whichever is greater.
- **Water and sanitary sewer:** 60 in. if crossing pavement or parallel less than 10 ft from pavement edge and 30 in. otherwise. UAR requires a minimum depth of 30 in., but not less than 18 in. below the pavement structure for crossings.

Special Provisions for Underground Utility Facilities at the Bryan District

Bryan District requires a 60-in. minimum depth of cover for high-pressure natural gas facilities that are under a drainage ditch or channel (164). UAR requires 30 in. for encased crossing lines or 48 in. for unencased crossing lines for high-pressure natural gas facilities.

Special Provisions for Underground Utility Facilities at the Pharr District

The special provisions in the Pharr District contain stricter requirements of the minimum cover of depth for the following utility facilities (165):

- **Low-pressure natural gas lines:** 60 in. for lines crossing pavements and 36 in. for all lines under a drainage ditch or channel, and for parallel lines under natural ground that are more than 10 ft from pavement edges. These requirements are stricter than the requirements in the UAR for encased crossing low-pressure natural gas lines. For encased crossings, UAR requires a depth of 18 in. or 1/2 the diameter of the pipe, whichever is greater, under pavement structure; 24 in. outside pavement structure and under ditches; or 30 in. for unencased sections of encased lines outside of pavement structure. However, UAR requires a 48-in. depth for unencased crossing lines outside pavement and under ditches, which is stricter than that of the special provisions.

- **High-pressure natural gas:** 60 in. for all lines crossing pavements and 48 in. for lines under a drainage ditch or channel, and for parallel lines under natural ground that are more than 10 ft from pavement edges. UAR has the same requirements for unencased lines but less strict requirements for encased crossing lines.
- **Copper telephone cables or TV cables:** 60 in. for all lines crossing pavements and 24 in. for lines under a drainage ditch or channel, and for parallel lines under natural ground that are more than 10 ft from pavement edges. UAR requires a depth of 24 in. under ditches or 18 in. beneath the bottom of the pavement structure, whichever is greater.
- **Water and sanitary sewer lines:** 60 in. for lines crossing pavements and 30 in. for lines under a drainage ditch or channel, and for parallel lines under natural ground that are more than 10 ft from pavement edges. UAR requires a minimum depth of 30 in., but not less than 18 in. below any pavement structure for all lines.

CHAPTER 4. REVIEW OF TXDOT BUSINESS PROCESS FOR OVERWEIGHT LOAD PERMITTING

INTRODUCTION

One objective of this research was to review the TxDOT business process for overweight load permitting to identify institutional issues, highlight areas where improvements are needed or required, and to identify potential integration points that can promote better coordination among TxDOT divisions as well as between TxDOT and utilities. As a result, the research team evaluated current and planned practices at TxDOT to manage overweight load routing and permitting. Specifically, the researchers performed a review of the overweight load permitting process in terms of procedures, data/information flows, and stakeholders, and gathered available information from the TxDOT Motor Carrier Division (MCD). The researchers interviewed TxDOT representatives from MCD and the TxDOT Right of Way Division (ROW) to complete the research team's understanding of overweight load permitting process activities and user data needs and to accomplish the following:

- **Review TxDOT's Overweight Permit Application Process.** The research team reviewed TxDOT's current overweight load permitting process and anticipated future changes. Discussion points during a meeting with MCD included the application process for various types of permits, data flows, applicant requirements, and certifications.
- **Review TxDOT's Overweight Routing Process.** The research team reviewed TxDOT's current overweight load routing process and anticipated changes due to the implementation of the Texas Permit Routing Optimization System (TxPROS). Discussion points for a meeting with MCD included data sets, data sources, data availability, data gaps, data flows, networks, routing algorithms, routing analysis results, routing options, and limitations. The research team requested data samples from relevant databases such as TxPROS to develop an understanding of the routing process.

To aid with the understanding of these issues, the chapter provides an overview of both state and federal overweight permit regulations, organization of permitting activities at MCD, and an overview of the TxDOT overweight permitting process, including the TxDOT overweight routing process.

RELEVANT OVERWEIGHT PERMIT REGULATION

United States Code

Title 23 Section 127 of the United States Code (USC) provides vehicle weight limitations for the interstate highway system (Table 36) (166). All states are required to allow vehicles on the interstate highways system with a weight up to but not more than the weight limits given in this section, unless a state decides to forfeit all its apportioned federal aid highway funds.

Table 36. Weight Limitations in the United States Code (166).

| | Maximum Axle Load (lb) | | Maximum Gross Weight (lb) | Section |
|---|------------------------|-------------|---------------------------|---------------------|
| | Single Axle | Tandem Axle | | |
| General weight limit | 20,000 | 34,000 | up to 80,000 (by formula) | 23 USC 127 (a) (1) |
| Heavy duty vehicles equipped with idle reduction technology | 20,400 | 34,400 | up to 80,400 (by formula) | 23 USC 127 (a) (12) |

The formula used to determine the maximum gross weight, also known as the Federal Bridge Formula, is as follows:

$$W = 500 \left(\frac{LN}{N-1} + 12N + 36 \right) \quad (20)$$

where

- W = overall gross weight on any group of two or more consecutive axles.
- L = distance between the extreme of any group of two or more consecutive axles.
- N = number of axles in group under consideration.

Section 127 also includes numerous exemptions for vehicles with higher maximum gross weights, as shown in Table 37. The first three exemptions to gross weight limits, shown with a grey highlight in Table 37, are exemptions that apply to all states: loads that cannot be easily dismantled but can be permitted in accordance with state laws, loads that comply with state weight regulations that predate the passing of this law (grandfathered states), and Longer Combination Vehicles (LCVs) authorized by state law before June 1, 1991. In addition to these exemptions there are also numerous state-specific exemptions to the maximum gross weight that have amended the law since the weight regulations first become law in 1958. Table 37 does not list temporary exemptions for over-the-road buses, intrastate public agency transit passenger buses, and firefighting vehicles because the exemptions expired without extension.

Table 37. Maximum Gross Weight Exemptions in the United States Code (166).

| Exemption Description | Max Gross Weight (lb) | Section |
|---|---|------------------------|
| Loads that cannot be easily dismantled or divided, which have been issued special permits in accordance with state laws (nondivisible loads). | exempt | 23 USC 127 (a) |
| Vehicles operating under state laws or regulations allowing higher weights established before July 1, 1956; or February 1, 1960, in the case of Hawaii; or May 1, 1982, in the case of Michigan; or June 1, 1993, in the case of Maryland; or January 1, 1987, in the case of Interstates 89, 93, and 95 in New Hampshire state (grandfathered states). | exempt | 23 USC 127 (a) |
| Longer Combination Vehicles, if authorized by state laws in actual lawful operation on a regular or periodic basis on or before June 1, 1991. | exempt | 23 USC 127 (d) |
| Vehicles operating on Interstate 29 between Sioux City, Iowa, and the Iowa/South Dakota border. | exempt | 23 USC 127 (a) |
| Vehicles operating on Interstate 129 between Sioux City, Iowa, and the Iowa/Nebraska border. | exempt | 23 USC 127 (a) |
| Motor vehicles hauling tank trailers, dump trailers, or ocean transport trailers after September 1, 1989. | exempt | 23 USC 127 (a) |
| Sugarcane vehicles during harvest season, up to 100 days per year in Louisiana. | 100,000 | 23 USC 127 (a) |
| Vehicles operating on certain portions of the Maine Turnpike. | exempt | 23 USC 127 (a) |
| Additional vehicle configurations authorized by state law no later than November 3, 1992, in Wyoming. | 117,000 | 23 USC 127 (d) |
| Additional vehicle configurations authorized by state law in certain parts of Ohio, Alaska, and Iowa. | exempt | 23 USC 127 (d) |
| Certain specialized hauling vehicles with a steering and tridem axle for coal, logs, and pulpwood on Interstate 68 in Maryland. | exempt | 23 USC 127 (e) |
| Certain specialized hauling vehicles in certain areas of Wisconsin and Pennsylvania. | exempt | 23 USC 127 (f) and (g) |
| Jet fuel bulk shipments in parts of Maine during national emergencies. | Exempt as determined by Secretary of Transportation | 23 USC 127 (h) |

Code of Federal Regulations

Section 127 of Title 23 USC is implemented in the Title 23 of the Code of Federal Regulations, in particular in sections 657 and 658 (*167, 168*). Section 657 provides the requirements for participating states to administer an enforcement program for these vehicle weight limits, including guidelines for the formulation of a plan for enforcement, evaluation of enforcement operations, FHWA certification, and effects of failure to enforce or certify state laws adequately. Section 658 identifies a national network of highways for oversize/overweight (OS/OW) travel and prescribes the national policy for truck and bus size and weights. As such, Section 658 restates the general axle and gross weight limits and state exemptions given in 23USC127, including the option for states to issue special permits without regard to axle weight, gross weight, or Federal Bridge Formula requirements for nondivisible loads. Appendix A of Section 658 lists all routes that are designated federal routes on the national network in addition to interstate highways. In Texas, no additional routes have been federally designated, so federal routes on the national network in Texas include all routes that were designated as federal-aid primary highways prior to June 1, 1991. Appendix C of Section 658 lists the weight and size provisions for LCVs that were in effect before the June 1, 1991, freeze, subject to public law 102-240. Since Texas did not have any special weight and size regulations for LCVs in place before the freeze, there are no regulations listed for Texas in this appendix.

Texas Transportation Code

Title 7 of the Texas Transportation Code Chapters 643, 645, and 646 require TxDOT to regulate motor carriers and motor transportation brokers to protect the welfare of the public and ensure fair treatment of consumers by household goods carriers (*169, 170, 171*). Additional requirements for TxDOT to prevent highway damage caused by overweight commercial motor vehicles can be found in Texas Transportation Code Chapters 201 and 370 (*172, 173*).

Transportation Code Chapter 621 defines single and tandem axle weights: a single axle weight is the total weight transmitted to the road by all wheels whose centers may be included between two parallel transverse vertical planes 40 in. apart, extending across the full width of the vehicle (*174*). A tandem axle weight is the total weight transmitted to the road by two or more consecutive axles whose centers may be included between parallel transverse vertical planes spaced more than 40 in. and not more than 96 in. apart, extending across the full width of the vehicle (*174*). Figure 13 is an illustration of the definitions for single and tandem axle weights showing a truck from the bird's eye view.

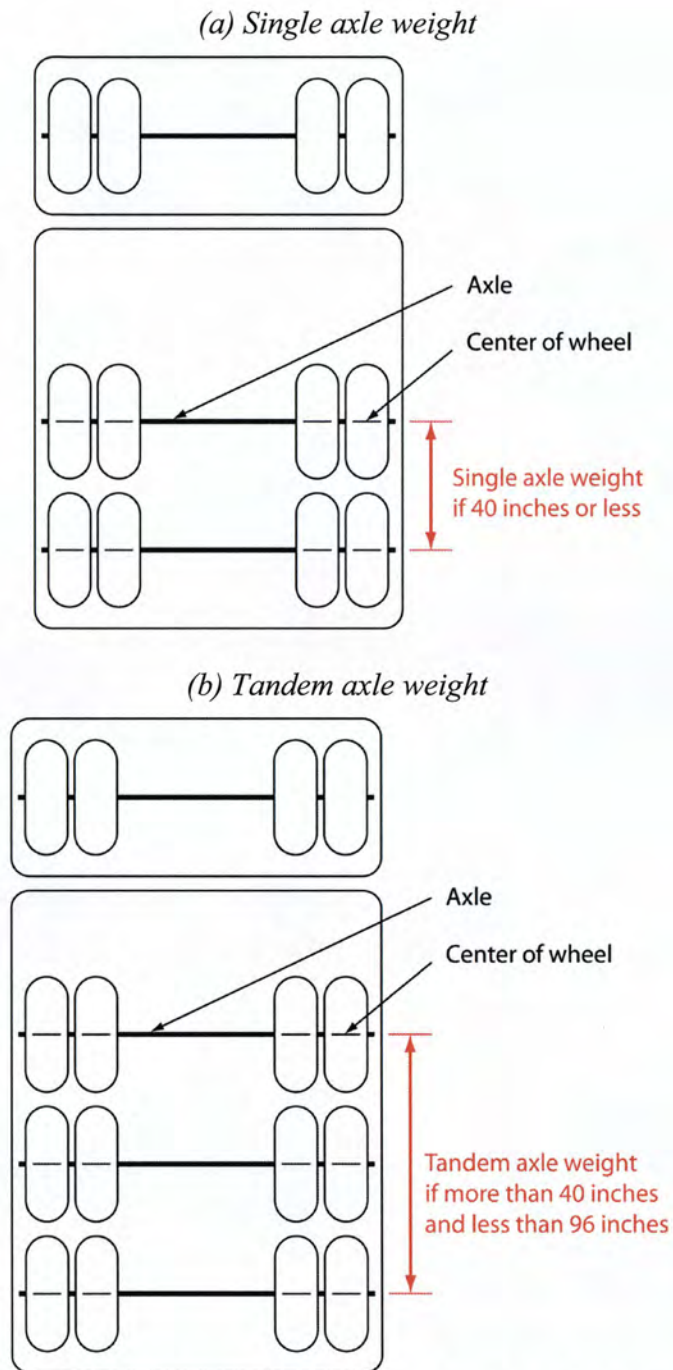

Figure 13. Definition of Single Axle and Tandem Axle Weight in the Texas Transportation Code.

Texas Transportation Code Section 621.101 provides the maximum axle and gross weights applicable for vehicles on highways in Texas, which follows the same limitations set forth in the United States Code (Table 38). Chapters 622 and 623, however, provide a number of special provisions and exceptions for oversize and overweight vehicles (175, 176). Most of the vehicles described in Chapter 622 do not need a permit, although a surety bond is required for some

vehicle types. Only certain heavy equipment and oil well servicing and drilling machinery requires a permit. Table 38 summarizes the maximum axle load and gross weight restrictions of Chapters 622 and 623.

Table 38. Weight Limitations in the Texas Transportation Code (175, 176).

| | Maximum Axle Load (lb) | | Maximum Gross Weight (lb) | Section | Permit |
|---|------------------------|------------------|--|---------------------|-------------------------------------|
| | Single Axle | Tandem Axle | | | |
| General | 20,000 | 34,000 | by formula, up to 80,000 | 621.101 | None |
| Ready-Mix Concrete Trucks | 23,000 25,300 | 46,000 50,600 | by formula, up to 80,000 if less than 69,000 | 622.012 | Exempt with bond approval |
| Vehicles transporting milk ¹ | 68,000 per axle group | | - | 622.031 | Exempt |
| Vehicles transporting timber or timber products | - | - | 80,000 ^a | 622.0431 - 622.0435 | Exempt |
| Recyclable Materials Trucks | 21,000 | 44,000 | 64,000 | 622.131 | Exempt with bond approval |
| Seed Cotton Transporters | - | - | 64,000 | 622.953 | Exempt |
| Chile Pepper Module Transporters | - | - | 54,000 | 622.953 | Exempt |
| Tow Trucks | - | - | - | 622.954 | Exempt |
| Commodity Trucks Crossing Highways | - | - | 110,000 ^b | 623.052 | Contract and bond approval required |
| Certain Heavy Equipment | - | - | 120,000 ^c | 623.017, 623.071 | Permit and bond required |
| Oil Well Servicing and Drilling Machinery | - | - | - | 623.141 | Permit required |
| Solid Waste | 21,000 | 44,000 | 64,000 | 623.161 | Exempt with bond approval |

¹ If distance between front wheel of forward tandem axle and rear wheel of rear tandem axle is 28 ft or more.

^a If vehicle is not longer than 90 ft, is not a truck tractor, and travels 125 miles or less, using an outer bridge of 39 ft or more except on bridges with lower maximum loads.

^b If vehicle is transporting grain, sand, stones, rock, caliche, or other commodity.

^c Cylindrical shaped bales of hay, oilfield drill pipe or drill collars stored in a pipe box, implement of husbandry by a dealer, water well drilling machinery and equipment, harvesting equipment, and superheavy equipment that cannot be reasonably dismantled not exceeding.

Texas Administrative Code

The Texas Administrative Code Title 43, Chapter 18 prescribes the policies and procedures for the regulation of motor carriers, transportation brokers, and other transportation businesses (177). Chapter 18 has six subchapters that cover general provisions, motor carrier registration, records and inspections, motor transportation, consumer protection, and enforcement. Chapter 28 of the Title 43 of the Texas Administrative Code provides regulations for oversize and overweight vehicles and loads (178). This chapter has 11 subchapters that provide general provisions; detail regulations for several types of overweight permits; and regulations for compliance, records and inspections, and enforcement.

The Texas Administrative Code defines that in general, TxDOT can issue permits for the transportation of cargo that cannot be reasonably dismantled when the gross weight exceeds the limits allowed by law, and several specific types of cargo such as cylindrically shaped bales of hay (179). The Code also states that a permit for an overweight transport is not a guarantee that the highway can safely support the movement, and that the transporter is responsible for any damage to the highway structure or its appurtenances.

The Administrative Code does not define maximum allowable axle weights, but rather provides limits for axle weights for which a permit can be requested. There is no overall maximum gross weight that may be permissible according to the Administrative Code, as long as all axle weights are within the permissible limits. However, some types of permits can only be acquired up to a certain gross weight. Table 39 provides a summary of maximum permissible weight limits for motor vehicles in the Texas Administrative Code.

Table 39. Maximum Permit Weight Limits in the Texas Administrative Code (178).¹

| Permit Type | Single Axle (lb) | 2-Axle Group (lb) | 3-Axle Group (lb) | 4-Axle Group (lb) | 5-Axle Group (lb) | Trunnion Axle (lb) | Steerable Axle (lb/in. of tire) | Other Axle (lb/in. of tire) | Code Section |
|---|---------------------|-------------------|-------------------|-------------------|-------------------|--------------------|---------------------------------|-----------------------------|----------------------|
| General overweight permit | 25,000 | 46,000 | 60,000 | 70,000 | 81,400 | 60,000 | 650 | 650 | 28.11 (d) |
| General overweight permit, load restricted roads | 22,500 | 41,400 | 54,000 | 63,000 | 73,260 | 54,000 | 650 | 650 | 28.11 (d) |
| Subchapter D single trip permit | 25,000 | 46,000 | 60,000 | 70,000 | 81,400 | 60,000 | 650 | 650 | 28.12 (b) |
| Subchapter D single trip permit, load restricted road | 22,500 | 41,400 | 54,000 | 63,000 | 73,260 | 54,000 | 650 | 650 | 28.12 (b) |
| Subchapter D single trip permit, self-propelled off road vehicle | 45,000 | - | - | - | - | - | 650 | 650 | 28.12 (b) |
| Single-trip mileage permit, oil well related and unladen lift equipment vehicle | 30,000 ^a | - | - | - | - | - | 950 | 850 | 28.42 (b), 28.62 (b) |
| Quarterly hubometer permit, oil well related vehicle and unladen lift equipment vehicle | 30,000 ^a | - | - | - | - | - | 950 | 850 | 28.43 (b), 28.63 (b) |
| Annual permit, oil well related vehicle | 25,000 | - | - | - | - | - | 850 | - | 28.44 (a) |
| Annual permit, unladen lift equipment vehicle ² | 25,000 | 46,000 | 60,000 | 70,000 | 81,400 | 60,000 | 650 | 650 | 28.64 (a) |
| Annual permit, unladen lift equipment vehicle, load restricted roads ³ | 22,500 | 41,400 | 54,000 | 63,000 | 73,260 | 54,000 | 650 | 650 | 28.64 (a) |
| Port of Brownsville port authority permit ³ | 25,000 | 46,000 | 60,000 | 70,000 | 81,400 | 60,000 | 650 | 650 | 28.92 (c) |
| Chambers County permit ⁴ | 25,000 | 46,000 | 60,000 | 70,000 | 81,400 | 60,000 | 650 | 650 | 28.102 (c) |

¹ For axle groups with an axle spacing of less than 12 ft. The lesser of axle group weight or weight per in. of tire applies.

² For vehicles not exceeding 120,000 lb gross weight.

³ For vehicles not exceeding 125,000 lb gross weight.

⁴ For vehicles not exceeding 100,000 lb gross weight.

^a Single axle not connected to another axle by a weight equalizing suspension system.

TXDOT MOTOR CARRIER DIVISION

The TxDOT Motor Carrier Division (MCD) consists of three sections: the Business Services Section, the OS/OW Permit Section, and the Motor Carrier Operations Section (Figure 14). The OS/OW Permit Section has five branches, two Single Trip Routed Permits Branches, one Special Services Permits Branch, the Permit Applications & TPM Programs Branch, and the Super Loads Permits Branch. The division is an active member of the Western Association of State Highway and Transportation Officials (WASHTO) and Southeastern Association of State Highway and Transportation Officials (SASHTO).

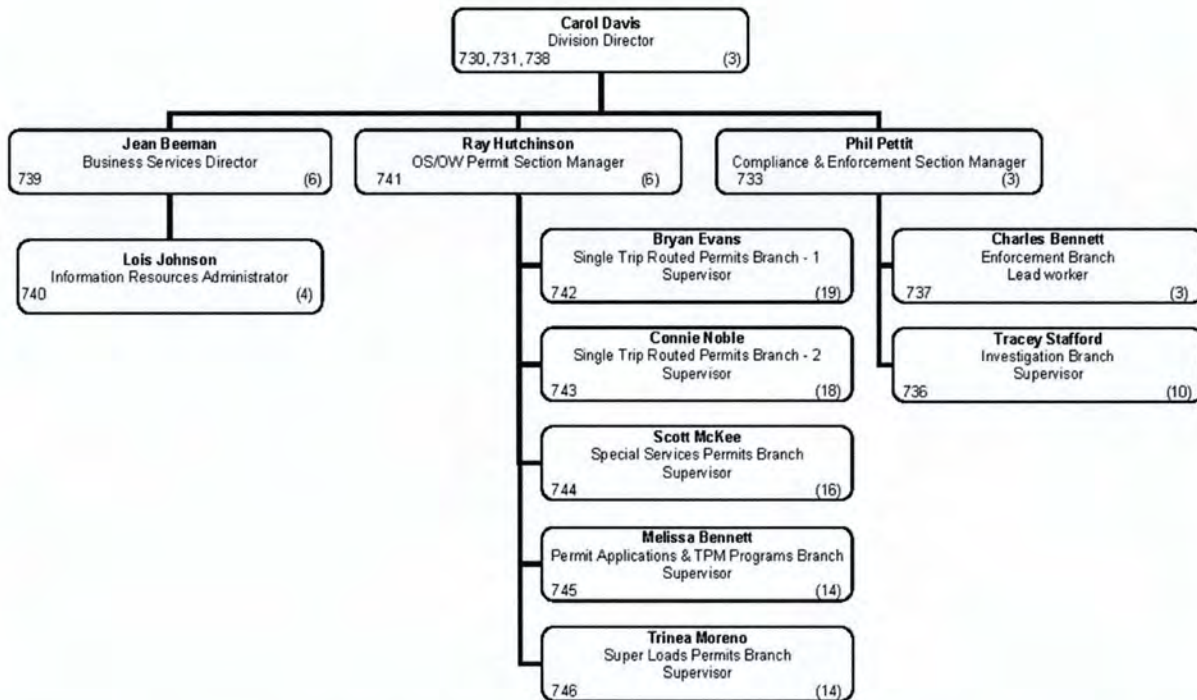

Figure 14. MCD Organizational Chart.

Overweight Permits

MCD handles approximately 500,000 permit applications per year for 25 different types of OS/OW permits and generates annual revenue of over \$100 million, which makes the MCD OS/OW Permit Section one of the largest OS/OW load permitting offices in the United States. Transportation Code Chapter 623 defines permits for oversize or overweight vehicles. Table 40 provides a listing of permit types and descriptions for overweight loads that are issued by MCD.

Table 40. Types and Authorization for Overweight Load Permits Issued by MCD (174, 176, 180, 181).

| Permit Name | Permit Description | Permit Applicability | Section |
|---|---|---|-------------------------------------|
| <i>Permit for Excess Axle or Gross Weight</i> | Annual permits for loads that cannot be reasonably dismantled (over axle/over gross weight tolerances permit) | <ul style="list-style-type: none"> • Valid for vehicles registered for a maximum gross weight of 80,000 lb • Allows axle weights up to 110% of the allowable axle weight and a gross weight of up to 105% of the allowable gross weight • Excludes movements on interstate highways and load-posted bridges when exceeding posted limits unless the bridge is the only public vehicular access to the permit holder's origin or destination • Permit can be issued for one or more counties | Subchapter B (623.011 – 623.019) |
| <i>Contract for Crossing Roads</i> | Permit to cross a highway from private property to other private property | <ul style="list-style-type: none"> • Grain, sand, or another commodity or product transporters with a gross weight up to 110,000 lb • Unlicensed vehicles transporting sand, gravel, stones, rock, caliche, or similar commodity | Subchapter C (623.051 – 623.052) |
| <i>Permit to Move Certain Heavy Equipment</i> | Single-trip, 30-, 60-, and 90-day permit for overweight (and oversize) loads (general OS/OW permit) | • Oilfield drill pipe or drill collars stored in a pipe box using farm-to-market or ranch-to-market roads | Subchapter D (623.071 – 623.082) |
| | Single-trip, 30-, 60-, and 90-day permit for the transportation of cylindrically shaped bales of hay | • Cylindrical shaped bales of hay | 623.071 |
| | Annual permit for superheavy equipment (annual envelope permit) | <ul style="list-style-type: none"> • Loads that cannot be reasonably dismantled up to 120,000 lb • Up to 12 ft wide, 110 ft long, 14 ft high • May be issued to a truck or a company | 623.071 |

Table 40. Types and Authorization for Overweight Load Permits Issued by MCD (174, 176, 180, 181) (Continued).

| Permit Name | Permit Description | Permit Applicability | Section |
|---|--|---|--|
| <i>Permit to Move Certain Heavy Equipment</i> | Annual permit for water well drilling machinery and implements of husbandry | <ul style="list-style-type: none"> • Water well drilling machinery • Farm/harvesting equipment • Movement of an implement of husbandry by a dealer | 623.071 |
| | Single-trip permit for a superheavy load. Requires analysis and routing by a TxDOT engineer | <ul style="list-style-type: none"> • Vehicle exceeding 200,000 lb with axle spacing less than 95 ft • Vehicles exceeding 254,000 lb regardless of axle spacing. | 623.078 |
| <i>Oil Well Servicing Units and Drilling Machinery Permit</i> | Single-trip, quarterly, and annual permit for oil well machinery | <ul style="list-style-type: none"> • Movement of oil well servicing and drilling permits | Subchapter G (623.141-623.150) |
| <i>Unladen Lift Equipment Motor Vehicle Permit</i> | Single-trip, quarterly, and annual permit for the movement of unladen lift equipment motor vehicles (mobile crane permit) | <ul style="list-style-type: none"> • Motor vehicles designed for use as lift equipment | Subchapter I (623.181-623.182) and Subchapter J (623.191 – 623.200) |
| <i>Multi-State Permit</i> | Single-trip permit under reciprocal agreement with a state participating in the WASHTO Western Regional Permitting program | <ul style="list-style-type: none"> • Single axle weight up to 21,500 lb • Tandem axle weight up to 43,000 lb • Tridem axle weight up to 53,000 lb • Gross weight up to 160,000 lb • Valid on highways of the regional network only | 621.003 |

Table 40. Types and Authorization for Overweight Load Permits Issued by MCD (174, 176, 180, 181) (Continued).

| Permit Name | Permit Description | Permit Applicability | Section |
|--------------------------------------|--|--|---------|
| <i>Temporary Registration Permit</i> | Single-trip, 72 hour, or 144 hour permit | <ul style="list-style-type: none"> • For commercial vehicles and buses owned by residents of the U.S., Canada, or Mexico • Allows the operator of vehicle to temporarily increase the maximum allowable weight for which a vehicle has been registered, up to the state axle and gross weight limits | 502.352 |

There are also a number of overweight load permits or authorizations in Chapter 623 that are not administered by MCD, as summarized in Table 41.

Table 41. Other Overweight Load Permits and Authorizations in the Texas Transportation Code (176).

| Permit Name | Permit Description | Permit Applicability | Section |
|--|---|--|-------------------------------------|
| <i>Authorization for Vehicles Transporting Solid Waste</i> | Solid waste transporters that carry a surety bond and present a copy to an officer authorized to enforce this section upon request. | <ul style="list-style-type: none"> • Vehicles with single axle weight up to 21,000 lb • Tandem axle weight up to 44,000 lb • Gross weight up to 64,000 lb • Excludes movements on interstate highways | Subchapter H (623.161 – 623.182) |
| <i>Port Authority Permit</i> | Permit for the movement of overweight (or oversize) load. | <ul style="list-style-type: none"> • Movements on state highways contiguous to the Gulf of Mexico or a bay or inlet opening into the Gulf and bordering Mexico • The Port of Brownsville and the Port of Victoria have authority to issue this permit. | Subchapter K (623.210 – 623.219) |
| <i>Victoria County Navigation District Permit</i> | Permit for the movement of overweight (or oversize) load in Victoria County. | <ul style="list-style-type: none"> • Certain portions of FM 1432 • Vehicles with a gross weight up to 125,000 lb | Subchapter L (623.230 – 623.239) |
| <i>Chambers County Permit</i> | Permit for the movement of overweight (or oversize) load in Chambers County. | <ul style="list-style-type: none"> • Certain portions of FM 1405 • A portion of the SH 99 frontage road • Certain portions of FM 565 • Certain portions of FM 2354 • Vehicles with a gross weight up to 100,000 lb | Subchapter M (623.250 – 623.254) |

Table 39. Other Overweight Load Permits and Authorizations in the Texas Transportation Code (176) (Continued).

| Permit Name | Permit Description | Permit Applicability | Section |
|---|--|-----------------------------|-------------------------------------|
| <i>Port of Corpus Christi Authority Permit</i> | Permit for the movement of overweight (or oversize) load on a roadway owned by the Port of Corpus Christi Authority. | | Subchapter O (623.280 – 623.288) |
| <i>Port of Corpus Christi Authority Special Freight Corridor Permit</i> | Permit for the movement of overweight (or oversize) load on a roadway owned by the Port of Corpus Christi Authority. | | Subchapter O (623.301– 623.310) |

A permit does not guarantee that the overweight movement can be made without damage to the highway, and many permits require the execution of surety bonds prior to the movement, in case there is damage to the highway. Other permits require a highway maintenance fee that increases with the gross weight of the vehicle, and for vehicles heavier than 200,000 lb a vehicle supervision fee that includes the cost for a bridge structural analysis, monitoring of trip progress, and movement of traffic control devices. Some permits are issued by rule of the Texas Transportation Commission. For these permits, specific language for applicability, limits, and requirements are not included in the Transportation Code. Regulations with respect to permit fees, validity period, and others for these permits are thus the responsibility of the Texas Transportation Commission, who must develop and pass the regulation by rule.

Permits for superheavy loads following section 623.078 require that TxDOT provide a specific route for the movement that the permit holder must follow. This type of permit, which is valid for a single movement only, is the most frequently issued permit at MCD and accounts for about 65–70 percent of the total permits issued by the office. Although routed permits for superheavy loads are the most frequently issued permit, superheavy loads are not the most frequent overweight load transports on the highway system. MCD issues other types of permits that are valid for unlimited trips over the duration of several weeks up to a year and thus may produce numerous trips using one permit. Figure 15 provides a sample of a single-trip, routed overweight permit for a movement with a gross weight of 92,000 lb.

In 2008, the number of annual and routed permits the division issued reached a peak of about 580,000. More recently, this number has decreased by about 20 percent due to reduced demand for permits that might be attributed to a general economic slowdown. MCD’s mission is to find a way to route OS/OW loads to their destinations following state and federal regulations and without undue damage to the TxDOT maintained infrastructure. In addition, when MCD determines a route it must consider numerous local restrictions such as height, size, and weight limitations. Frequently, the office has to develop innovative solutions to allow the delivery of heavy loads.



Texas Oversize/Overweight Single Trip Permit and/or Temporary Registration

| | |
|---------------------------------------|---------------------------------------|
| Name: [REDACTED] | Permit Number: [REDACTED] 4825 |
| Address: [REDACTED] | Issued On : 11/30/2009 Time: 15:49:01 |
| Account: [REDACTED] Phone: [REDACTED] | Effective : 11/30/2009 |
| Applicant: [REDACTED] | Expiration : 12/04/2009 |
| | Permit Officer : [REDACTED] |

| | |
|--|-----------------------|
| Load Description: JOHN DEERE 624J FORKLIFT | Gross Weight: 92,000 |
| Max. Width: 10' 0" Max Height: 13' 6" Max. Length: Legal | ROH: Legal FOH: Legal |

| | | | | | |
|-------------|--------|--------|--------|--------|--------|
| Axle: | 1 | 2 | 3 | 4 | 5 |
| Distances: | 19 | 4 | 36 | 4 | |
| Weights: | 12,000 | 20,000 | 20,000 | 20,000 | 20,000 |
| # of Tires: | 2 | 4 | 4 | 4 | 4 |
| Tire Sizes: | 11 | 11 | 11 | 11 | 11 |

| | | | |
|------------------|----------|------------------------|---------|
| Truck: | Trailer: | Temporary Registration | |
| 2001 / Peterbilt | | Truck | Trailer |
| 18443 | | Start: | Start: |
| P589523 / IL | | End: | End: |

Route Description: Starting City: TOMBALL Ending City: NM LINE
 ...JCT TIMBERTECH LN/SH249n, X-OVER @ NORTHPOINT BLVD TO SH249s, N.BW8.FRw/s, IH10w, SAN ANTONIO E.LP1604n/w, IH10w...

BEXAR COUNTY/8PM TO 6AM: CAUTION MUST BE USED ON ALL STATE MAINTAINED HIGHWAYS WHEN TRAVELING ON OR INSIDE LP1604 DUE TO NIGHTLY LANE OR HIGHWAY CLOSURES; LOADS MAY BE DIVERTED TO FRONTAGE ROADS OR CITY STREETS.

THIS IS A LOWBOY TRAILER
 LOAD #2777042

Special Conditions:
 Use caution at all railroad crossings. Railroad crossing hotline: 1-888-877-7267.
 Permit is valid for one trip only. Not valid without movement conditions sheet attached.
 Escorts: Over 14' wide, or 110' long = one escort. Over 16' wide, or 125' long = two escorts.
 Over 17' high = front escort with height pole. Over 18' high = front escort with height pole and rear escort.
 If the load is over two dimensions that require escorts, then front and rear escorts are required.
 A rear escort is required when the front or rear overhang exceeds 20'. When one escort is required, escort should be in front on a two lane hwy and in rear on a multi-lane highway. Only overweight/overlength loads may travel IH35 inside travel lane in Austin.
 Self-propelled oil well servicing units that do not exceed 9' wide, 14' high, or 65' long are allowed night movement.
 All loads exceeding 8'6" wide and/or 13'6" high may not travel on the main lanes of IH35 between US183/SH71 in Austin.
 El Paso District: Over 17'6" high= front escort with height pole.
 Odessa, San Angelo & Abilene Districts: Over 16' wide= one escort. Over 18' wide= front & rear escorts.
 Odessa, San Angelo & Abilene Districts: 16' wide & 95' long combination = front & rear escorts. Over 18' high =front escort with height pole.
 Lubbock District-Gaines & Dawson Counties only: Over 16' wide= one escort. Over 18' wide= front & rear escorts.
 Lubbock District-Gaines & Dawson Counties only: 16' wide & 95' long combination = front & rear escorts. Over 18' high =front escort with height pole.

| | | |
|--|------------------------------------|--------------------------|
| Amadeo Saenz Jr., P.E., Executive Director Texas Department of Transportation | Payment Method : PAC | Permit Fee: \$30.00 |
| | Trace # : [REDACTED] | Registration Fee: \$0.00 |
| | Wire Co. Name: | Overweight Fee: \$150.00 |
| | Permit Destination: McDonough, GA. | Other Fee: \$30.00 |
| | Amendments : | Total Fee: \$210.00 |

State law requires permit to be carried in vehicle until one day after expiration.
 For more information, call the Texas "One Stop Shop" toll free number at 1-800-299-1700 or visit our website at www.txdot.gov .

Figure 15. Sample Single Trip Permit.

TXDOT OVERWEIGHT PERMITTING PROCESS

The permitting process at MCD mainly includes the following four steps:

1. **Application Submission.** To apply for a permit, a customer needs to first submit an application for an overweight permit to MCD. Specialists at the Permit Applications & TPM Program branch take all applications that MCD receives and input the information into the queue for the correct permit type. MCD receives about 75 percent of their applications online through their central permitting system (CPS). The rest are submitted through phone, fax, and mail. Very rarely, customers submit applications in person at district offices, which then submit the application to MCD.
2. **Application Processing.** After permit application information is entered into the permitting system, the information is passed to the appropriate permit specialist based on the conditions of the application. The specialist extracts required information about loads, origins, and destinations, and determines the correct permit type. If the permit requires a defined route, the specialist will identify a suitable route that does not have restrictions or other barriers. Permit applicants sometimes indicate preferred routes in their applications. In these cases, permit specialists will need to verify the preferred route against the restriction map as well as the temporary restrictions and approve the routes or otherwise identify an alternative permissible route.
3. **Permit Delivery.** Upon approval of an application, MCD will issue a permit and mail the permit to the applicant.
4. **Post Processing.** In some cases, customers find the route provided by MCD is not optimal, or may request an alternative route. Upon receipt of a request for an alternative route, MCD reviews the request and if the movement is possible on the requested route, may issue a permit amendment or a new permit, as necessary. The special services permits branch handles all special permits as well as permit amendments.

The goal of MCD is to process 90 percent of the general permits within 90 minutes after they are submitted. On a busy day, many permits may actually take up to 120 minutes. Processing applications for superheavy load permits takes much longer, frequently weeks, due to the separate analyses needed for those permits.

The most challenging activity in the permitting process is the identification of appropriate routes for superheavy loads. As described in the previous sections, numerous regulations, special permits, and exceptions allow overweight loads, with different regulations for federal and state highways. Depending on the specifics of the load that needs to be routed, interstate highways may or may not be included. In some cases, it is necessary to use county roads, for which a permit cannot be obtained through MCD but must be acquired from the County, which results in a route that ends at the county road and starts up again at the next state highway.

The main difficulty of identifying an appropriate route for overweight loads is to ensure that the route complies with current local highway restrictions. Currently, this is a manual process that starts with a current set of district highway maps and numerous folders that contain memos and

descriptions of highway restrictions in each district. Each MCD routing specialist must then systematically and meticulously transcribe all restrictions from the memo sheets to the district maps to create a set of district maps with current highway restrictions. To determine an appropriate route, the MCD specialist reviews his restriction map set and develops a route by selecting the shortest possible route between requested origin and destination that does not violate a restriction. The restriction map set must be carefully updated every morning when MCD receives updates on current and new restrictions from district officials.

MCD primarily relies on individual districts for temporary restriction information. Districts are supposed to notify MCD at least 24 hour prior to a temporary restriction goes into effect and update the information with MCD as soon as it is canceled. One issue that MCD has identified is the communication between MCD and district staff. MCD is dependent on information from the districts about new restrictions and old restrictions that are no longer required. For the most part, districts are very pro-active about new restrictions and notify MCD in a timely manner. However, districts are less efficient with regard to notifying MCD when an existing, temporary restriction is no longer needed. Occasionally, district restrictions affect routing at MCD long after the restriction is no longer required because MCD was not notified to remove the restriction.

Communication issues between MCD and districts were also one of the findings from the OS/OW Working Group that consists of engineers from the north and east Texas (NETx) district and division representatives. A meeting of maintenance and operations engineers in Tyler in November 2006 resulted in the formation of a “Superheavy and Overweight Load/Seal Coat Damage Prevention Work Group,” consisting of staff from NETx districts, MCD, the Construction Division (CST), and MNT (182). The kick-off meeting of this working group occurred in April 2007 and resulted in eight key issues that were subsequently reduced to the topic areas of reduce seal coat damage, improve route options for OS/OW loads by maintaining open corridors, and improve communications between districts and divisions regarding OS/OW routes.

Based on these objectives, the working group identified problem areas and developed a list of major action items or concerns. Table 42 summarizes issues related to improving communication between districts and divisions, which illustrate the need for the development of a business process to improve communication and coordination of stakeholders.

Table 42. Action Items or Concerns Expressed by NETx Engineers (182).

| Description of Action Item or Concern | Potential Solution | Additional Needs |
|---|--|---|
| Districts do not always tell MCD about carriers not complying with routes or other permit requirements. | GroupWise account and enforcement. | Better education of process to districts. |
| MCD permit coordinators do not always inform districts of permit issue and expiration dates. | Establish GroupWise proxy account. | TxPROS will allow districts to view routing info. |
| District route restrictions must be kept current. | Better communication from MCD to districts. | Review restrictions quarterly. |
| Districts are not being notified by carriers as load is moved even though instructed to do so. | Enforcement, carrier, and MCD meetings. | Technology to track permit load via satellite. |
| Better communication from seal coat contractor since work is done on county basis and unpredictable. | Better communication from contractor to TxDOT. | Penalty for not complying. |
| Districts must discuss with each other open routes and construction plans. | GroupWise proxy account. | Each district has two N-S corridors, one always open. |

The research team confirmed that MCD has dedicated map coordinators who coordinate with districts closely to verify restrictions and update existing information. MCD also conducts quarterly routine verifications with individual districts to update all temporary restrictions.

Staffing and Quality Control

To ensure productive and high-quality operations, the MCD permitting section has established effective staff training programs and quality control mechanisms. Staff are sufficiently trained and tested before they can participate in the highly technical application process. Each branch within the office has an efficient management hierarchy consisting of team leaders, lead workers, and regular permit specialists. Permitting specialists must have a 94 percent overall accuracy rate. A quality inspection team conducts daily quality inspection of permits randomly drawn from each permit specialist. Inspection results are also reflected in staff performance evaluations. The inspection also allows the office to identify incorrect permits and correct them before the movement occurs on unsuitable roadways.

TxPROS

TxPROS is an automatic OS/OW load permit processing system that is currently under development. The new system will have a permitting component and a GIS map component and is based on an Oracle database. Compared to the current permitting process that heavily involves manual processing, the upcoming system has several advantages. For example, it can apply restrictions automatically to all permits as soon as they are entered into the system. When a new restriction comes into effect, the system can also identify all affected ongoing permits and send

out notifications to customer automatically. MCD has been using the beta version of TxPROS for testing. Some users will be able to use the system in 2010 for further testing and feedback. The final public release of the system is currently scheduled at the end of 2010.

Currently, TxDOT only permits routes on the state highway system. Customers will need to coordinate with affected counties and/or cities in order to travel on off-system roadways to the final destinations. TxPROS is designed to have the ability for multi-jurisdictional routings, although TxDOT currently does not have authority to route overweight/oversize loads on off-system roadways. Some counties and cities (e.g., Harris County) have started efforts to modify relevant regulations and laws so that MCD can route loads on their roadways as well. It is MCD's intention that TxPROS can operate on a roadway network combining all on- and off-system roadways with restrictions directly inputted from TxDOT as well as counties and cities.

TxPROS will provide a wealth of data, including a GIS map of routes assigned for superheavy loads. This map will allow TxDOT to identify routes that are more heavily impacted by superheavy loads. MCD also has plans to convert the last four years of permits in the current CPS and enter them into TxPROS.

TxPROS has two methods to limit travel on specific network routes, which are temporary restrictions and impedances. In TxPROS, all restrictions and impedances are applied to a network segment.

- **Temporary Restrictions.** Temporary restrictions disallow the movement of a restricted load over that segment and effectively block the segment for inclusion in the routing determination.
- **Impedances.** TxPROS uses impedances to identify the optimum route when multiple options are available. An example of a TxPROS impedance is roadway length. TxPROS permitting specialists can manually adjust the length values of certain road sections so that road selections for routes are more balanced over the road network, or to encourage the system to use more preferred routes.

According to MCD, if locations of buried, critical utility infrastructure can be identified, the information would be most likely used as a load restriction in the system so that unsuitable loads are not routed over the buried utility. Alternatively, wear and tear on the utility facility could be reduced by introducing a local segment impedance.

CHAPTER 5. PHASE 1 UTILITY DAMAGE EVALUATION

INTRODUCTION

This chapter summarizes the efforts of the research team to develop a risk analysis framework and assess vulnerability of buried utility plant to the effects of overweight vehicles. The research team proposed to develop the risk framework based on a forensic field investigation at selected sites with known damages to buried utility infrastructure caused by overweight loads. This effort included the following three tasks:

- **Task 1: Analysis of Overweight Loads on TxDOT Highway System.** The research team requested permit data from MCD and processed the data for use in a spatial route analysis using a GIS.
- **Task 2: Identification of Damage Cases.** The research team developed strategies to identify damage to buried utilities caused by overweight vehicle movements and contacted stakeholders to identify locations for field investigations in the state right of way.
- **Task 3: Sensitivity Analysis of Damages to Buried Utility Structures.** The research team conducted a sensitivity analysis using a 2D finite element program based on typical and critical parameters for the installation of utilities in the state right of way. This analysis was useful to develop a preliminary assessment of the vulnerability of buried utility plant in the state right of way.

The following provides a detailed description of the activities of the research team for the tasks outlined above.

ANALYSIS OF OVERWEIGHT LOADS ON TXDOT HIGHWAY SYSTEM

Overview

The research team requested and received six fiscal years (2004–2009) of overweight load permit history for analysis and reporting purposes from MCD. The purpose of the request was to analyze the route descriptions and convert the available text information into route segments that could then be converted to route features in a GIS. The outcome of the process would be a geodatabase that would contain route features of permitted overweight truck movements for fiscal years 2004 through 2009. The geodatabase could then be used to display permitted overweight routes on a map of Texas highways and to conduct spatial analysis of frequently used routes for overweight load traffic. The research team then planned to contact utility owners in locations of frequent overweight load traffic, to assess potential damage on buried utility facilities caused by overweight load traffic. Table 75 shows the number of records available for each year, the percent increase of overweight load permits from one year to the next, and the total number of records available to the research team.

Table 43. Total Overweight Load Permits.

| Fiscal Year | Number of Permits | Percent Increase |
|--------------------|--------------------------|-------------------------|
| 2004 | 445,081 | |
| 2005 | 482,230 | 8.3% |
| 2006 | 523,474 | 8.6% |
| 2007 | 556,338 | 6.3% |
| 2008 | 582,583 | 4.7% |
| 2009 | 529,900 | -9.0% |
| Total | 3,119,606 | |

The significant effort to process and convert the permit data to route features was shared with two additional research projects, project 0-6498 (“Texas Energy Developments and TxDOT Right of Way”) and project 0-6404 (“Accommodating Oversize and Overweight Loads”). During the first year of the research, the research team analyzed the data, processed the permit route descriptions, and created a dataset of route descriptions for processing in a GIS. At the end of fiscal year 2010, TxDOT requested to bundle GIS processing for fiscal year 2011 in project 0-6404, which completed the route data processing by the end of fiscal year 2011. Since it was apparent that GIS route data would not be available in time to aid with the identification of locations of potentially damaged utility structures, the research team adopted a “proactive approach” to estimate impacts of overweight traffic on buried utilities. This approach is described in detail following this summary of the analysis of overweight load data. This chapter also summarizes the efforts of researchers working on project 0-6404 to reconstruct permit routes to provide a complete picture of the overweight route analysis processing. A detailed description of the overweight load data processing is included in Appendix B.

Initial Data Analysis

Researchers imported the route information into a Microsoft Access 2007 database in order to perform a review of the data structure. The OS/OW load permits database consists of 128 fields in one table that is not normalized. The researchers observed that the analysis of overweight load permit route data needed to focus on the data in the fields “ROUTE_START,” “ROUTE_END,” and “ROUTE_DESC.” For the majority of records, the field ROUTE_START provided the starting city of the route, and the field ROUTE_END provided the city in which the route ended. The field ROUTE_DESC provided a description of the specific route between the ROUTE_START and ROUTE_END cities. However, route information provided in the route description field was not immediately ready for use with a GIS because of several reasons:

- The syntax used for route starts, route ends, and route descriptions was not standardized and contained spelling errors, blank entries, and unknown entries.
- Abbreviations used for route starts, route ends, and route descriptions were not consistent.

- The route description field contained multi-line records in which only one line corresponded to the route information.
- Some records contained uncommon characters such as “r” that cluttered the picture and made it more difficult to use the information.

In order to create route features in a GIS, the research team determined that spelling errors and abbreviation variations of Texas cities in the ROUTE_START and ROUTE_END fields had to be resolved using an intensive data cleaning process. The research team found that data entered in the route description field were not selected from a set of valid values and did not follow a defined data standard. This lack of data integrity and standards in the data entry process was the primary reason for the extensive data cleansing process, including the restructuring of several tables before the data could be utilized for processing or recreation of overweight routes.

Given the amount of data and lack of quality control in the dataset, the research team realized it would be an enormous task to parse and process this data. In order to be more efficient in this process, the task of data cleansing and processing was divided and assigned to two separate task forces. Task force one located in College Station focused on the processing and cleaning of the route description field, and task force two located in San Antonio focused on the processing and cleaning of the route start and route end fields.

Route Description Processing

The processing of the route descriptions started with a separation of permits that did contain data in the route description field from those that did not contain any data in the route description field. Table 79 shows the total number of permits, the number of permits that did not contain route information, and the number of permits with route information. These 2.6 million records, or 84 percent of all permit records, were used in the subsequent data cleaning process.

Table 44. Total Permits and Permits with Defined Routes in Route Description Field.

| Fiscal Year | All Permits | Permits without Route Descriptions | Permits with Route Descriptions | Permits with Route Descriptions (% of All) |
|--------------------|--------------------|---|--|---|
| 2004 | 445,081 | 57,965 | 387,116 | 87.0% |
| 2005 | 482,230 | 64,967 | 417,263 | 86.5% |
| 2006 | 523,474 | 77,498 | 445,976 | 85.2% |
| 2007 | 556,338 | 92,717 | 463,621 | 83.3% |
| 2008 | 582,583 | 99,447 | 483,136 | 82.9% |
| 2009 | 529,900 | 96,136 | 433,764 | 81.9% |
| Total | 3,119,606 | 488,730 | 2,630,876 | 84.3% |

The College Station task force developed a five-step string parse data cleansing process using Microsoft Excel and Visual Basic for Applications (VBA) to clean the 2.6 million records with route information. The data cleansing process included the following five steps:

- **Step 1: Standardize Route.** Route names are standardized to follow a 2-character-4-digit convention, which is used in the “Route” database. For example, “IH10” becomes “IH0010” and “Loop 1604” becomes “LP1604.”
- **Step 2: Separate Multi Line Records.** There are a large number of records with data that spans multiple lines. This step separates each line into individual fields.
- **Step 3: Identify Valid Route Information.** This step identifies the line of the multi-line records that contains valid route descriptions.
- **Step 4: Remove Unwanted Characters.** This step includes the replacement of certain characters to standardize the route description format.
- **Step 5: Route Data Cleaning.** Implement the route data cleaning logic using brackets to mark the beginning and end of landmark description, “ ? ” and “ \$ ” to mark the beginning and end of questionable information, and “ _ ” for direction information.

At the end of the route description processing, the research team created two data subsets: Clean routes and routes that contained a problem or error. Table 81 shows the number of records that contain clean versus flagged route descriptions after the five-step data cleansing process. Figure 82 shows the size of the datasets at the conclusion of the data cleansing process.

Table 45. Permits with Clean and Permits with Flagged Route Descriptions after Five-Step Data Cleansing Process.

| Fiscal Year | Permits with Routes | Permits with Clean Route Descriptions | Permits with Flagged Route Descriptions |
|--------------------|----------------------------|--|--|
| 2004 | 387,116 | 188,829 | 198,287 |
| 2005 | 417,263 | 188,993 | 228,270 |
| 2006 | 445,976 | 202,272 | 243,704 |
| 2007 | 463,621 | 191,157 | 272,464 |
| 2008 | 483,136 | 220,369 | 262,767 |
| 2009 | 433,764 | 216,692 | 217,072 |
| Total | 2,630,876 | 1,208,312 | 1,422,564 |

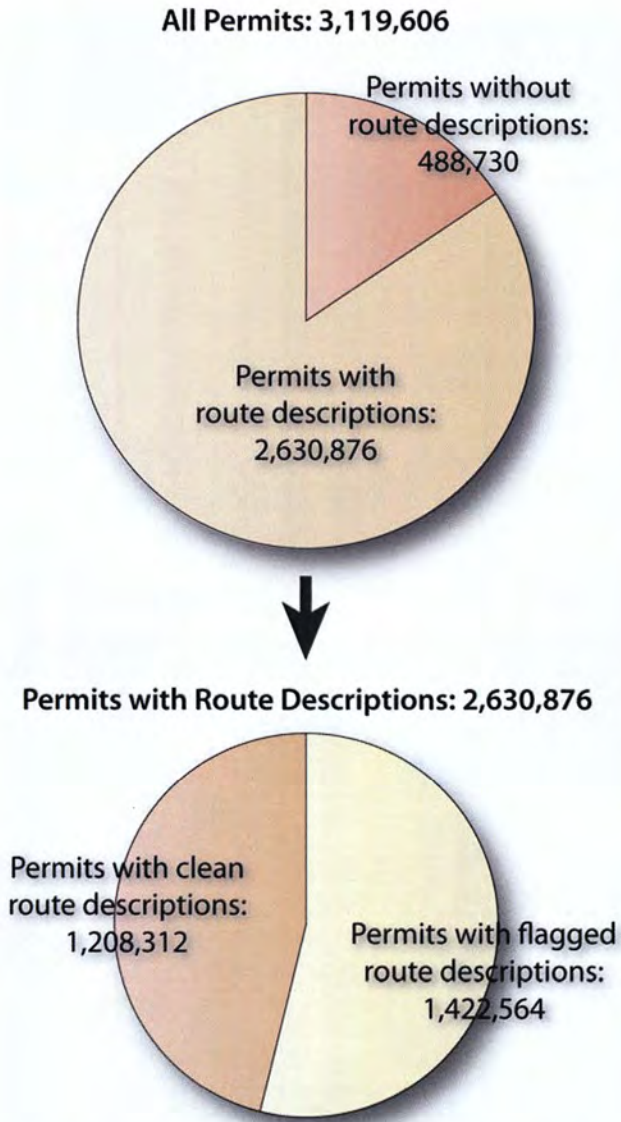

Figure 16. Route Description Data Processing.

More than half the records were flagged for an issue that the algorithm could not resolve. The algorithm flagged records for any of the following five issues:

- **Route not identifiable issue.** A number of permits were flagged because the entry in the route description could not be programmatically identified as a valid route.
- **Missing direction issue.** A number of permits were flagged because the entry in the route did not provide a valid direction, e.g., n, e, s, w, in the route description.
- **Unknown information issue.** Some permits were flagged because the entry in the route description field provided unknown information before the term “JCT” in the route description.

- **Unknown route issue.** Other permits were flagged because the entry in the route contained a highway that could not be recognized in the database. In contrast, if multiple highways were found for a record, this flag was not assigned.
- **Multi-spur route issue.** A small number of permits were flagged because the entry in the route contained a highway designated as a spur with multiple matches in the route description.

Route Start and Route End Processing

The second portion of the data cleansing process was carried out by the San Antonio task force, focusing on the fields ROUTE_START and ROUTE_END. The purpose of the analysis was to review and clean these fields as needed, to develop data elements that would be useful to provide the longitude and latitude for start and end of each routes. These data could then be used for the development of GIS route or origin-destination maps. The data standardization process consisted of six phases and multiple steps, which are described below. Following the description are sections that provide additional process information and examples for each phase separately.

- **Phase 0: Data Conversion.** Phase 0 consisted of converting each fiscal year's information received from TxDOT from a dBase V format database into a Microsoft Access 2007 database.
- **Phase 1: Remove Duplicates.** Phase 1 consisted of setting aside records with a duplicate permit ID and storing these records in the "duplicates" dataset. Remaining data are stored in "distinct permits" dataset.
- **Phase 2: Remove Null Data.** Phase 2 consisted of using the Phase 1 "distinct permits" dataset and separating permit records that do not have a route start, route end, and route description ("is null" dataset). Figure 89 shows the portion of records that contained no data.

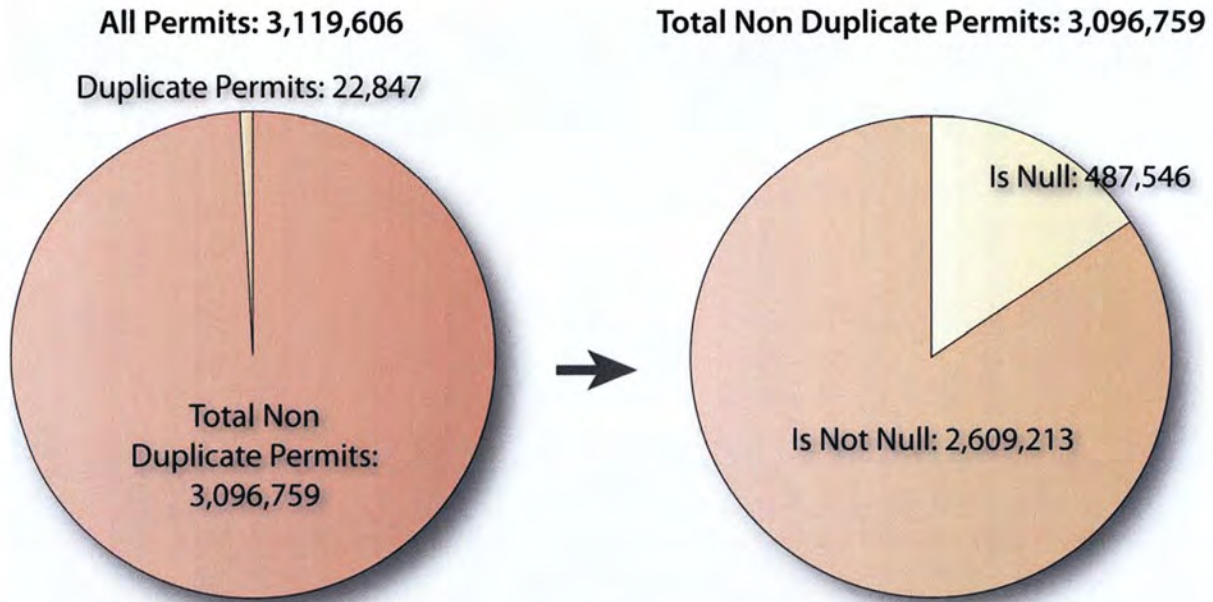

Figure 17. Development of Is Null and Is Not Null Datasets.

- **Phase 3: Identify JCT Records.** Phase 3 consisted of identifying records in the “is not null” dataset (Phase 2, Step 2) that use the term “JCT” (Junction) or a variety of that term in the route description field.
- **Phase 4: Identify Valid Route Descriptions.** Phase 4 consisted of parsing both the “JCT” and the “not JCT” dataset for information in the route description field that contained valid route descriptions. The result was four datasets: JCT, with and without valid route, and Not JCT, with and without valid route. Figure 18 shows the portion of records in the four datasets.

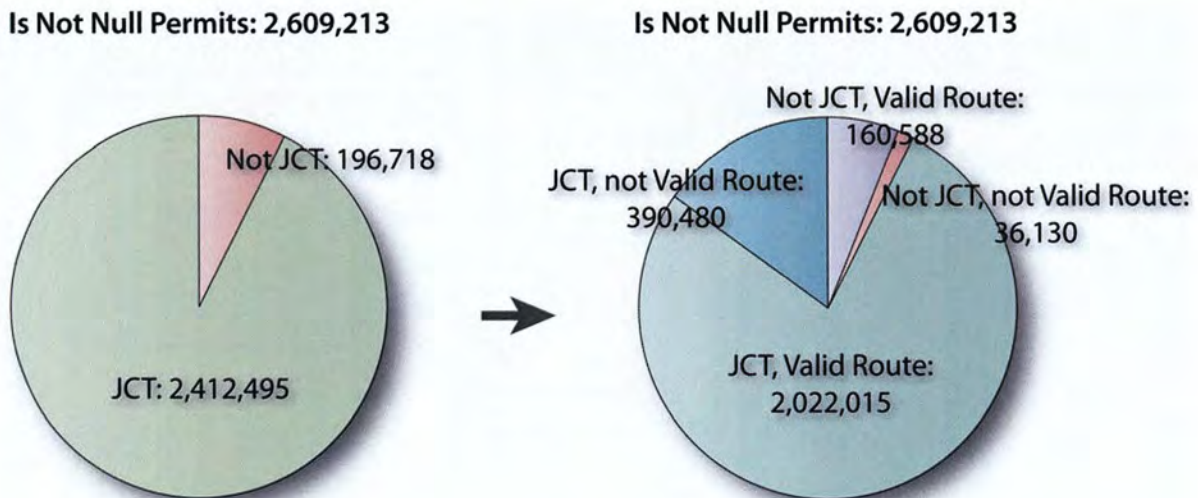

Figure 18. Development of JCT and Not JCT Datasets.

- **Phase 5: Remove Duplicate Records in the Duplicates Dataset.** Phase 5 consisted of reviewing the dataset of records with duplicate permit IDs (“duplicates,” Phase 1) and eliminated records where all fields are equal.
- **Phase 6: Standardize Route Descriptions.** Phase 5 consisted of standardizing the content in the route start and route end fields.

Final Data Processing and Merge

In the final data processing and merge step, the researchers combined datasets from Phase 6 to create datasets for the development of GIS maps. The merge was completed in two phases and multiple steps, as follows:

- **Phase 7: Import All Route Descriptions.** Phase 7 prepared the dataset processed by the College Station task force for subsequent merging in Phase 8. The main task of this phase was to import the data from an Excel spreadsheet into a Microsoft Access 2007 database using Access 2003 format. The researchers called this dataset the “all processed route descriptions” dataset.
- **Phase 8: Merge Datasets.** This phase focused on the merging of several datasets to produce the final, clean datasets for GIS processing. The researcher merged several datasets to create one dataset called “Path.” This dataset was created for GIS processing of the route description and creation of GIS route features. The researchers also merged several other datasets to create one dataset called “Origin destination.” This dataset was created for GIS processing of the route start and route end field and creation of origin-destination maps. Figure 5 shows the six datasets that were combined to form the “Path” and “Origin destination” datasets.

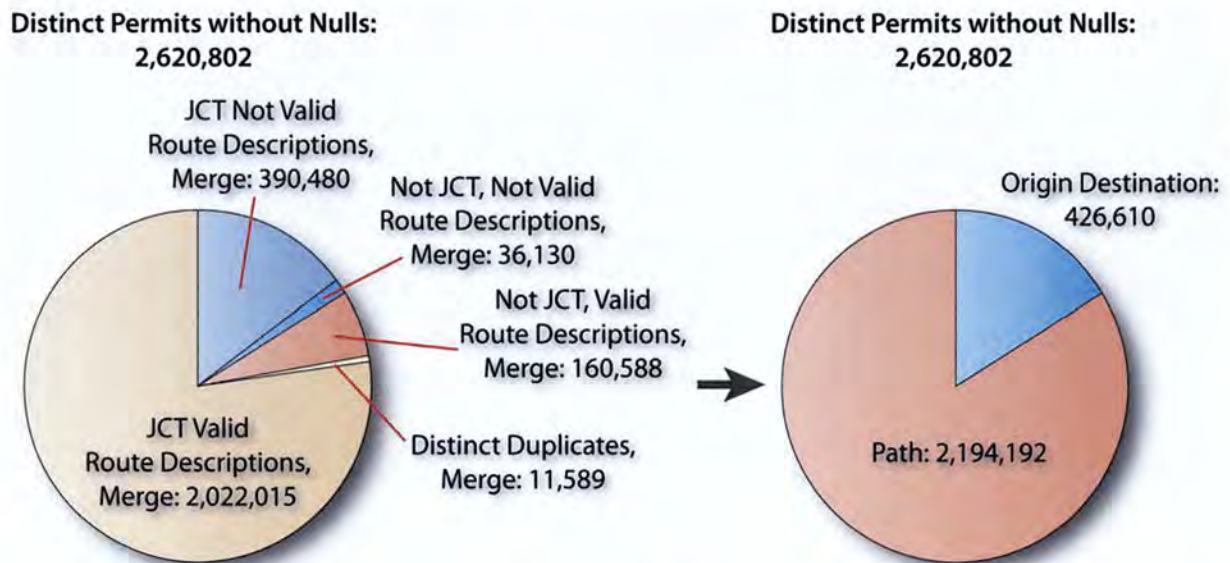

Figure 19. Development of Origin Destination and Path Datasets.

Reconstruction of Permit Routes

Researchers working on project 0-6404 used the merged datasets produced in Phase 8 and developed a modified shortest path algorithm in ESRI ArcGIS Desktop to reconstruct the overweight permit routes from the route description field. In order to generate GIS routes from the route descriptions processed in previous steps, researchers developed several GIS programs that involved further data processing. The overall process included the following major steps:

- Preparation of route network.
- Junction layer creation.
- Generation of route shapefiles and attribution.
- Post processing of route shapefiles.

Preparation of Route Network

A required component for creating shapefiles from standardized route descriptions was a navigable route network. The route descriptions only involved on-system routes; local routes between origin or final destination and the nearest access points on a state route were not described. Therefore, it was necessary to construct a route network using a TxDOT roadway network.

The research team used the 2009 PMIS roadway network as the basis for the route network. Preparing the network required a check of all roadway intersections in the network to ensure the network was fully navigable and correctly reflected ground conditions. Researchers performed this check both manually and programmatically, i.e., by testing connectivity through generating a sample of complex routes. Major considerations and challenges the research team encountered during the preparation of the route network included network connectivity and network attributes.

After making necessary improvements to the 2009 PMIS layer, the researchers generated a route network layer using the Network Analyst tool available in ArcGIS Desktop. This route network was used during the subsequent steps for GIS reconstruction of the permit routes.

Junction Layer Creation

Another critical component for the route feature creation was a point layer that corresponded to all intersections, origins, and destinations contained in route descriptions that was spatially linked to the route network layer. This layer was needed so that for each permit route, the automated route generation program was able to identify the route origin, destination, and all intermediate intersections. Researchers named this layer the “junction layer” for convenience. To generate this layer, researchers needed three types of point features:

- **Highway-state line intersections.** The research team generated highway-state line intersections by intersecting the 2009 roadway network layer with a Texas state polygon layer.

- **Texas cities.** The research team created a point layer of Texas cities based on the coordinate information contained in the tabular dataset using the “Display XY Data” tool in ArcGIS Desktop.
- **Highway intersections.** The research team generated a point layer of highway intersections by extracting all intersections of the on-system roadway network using the “Intersect” tool in ArcGIS and then manually adding missing intersections.

The research team combined all three types of point features into a single junction layer shown in Figure 20.

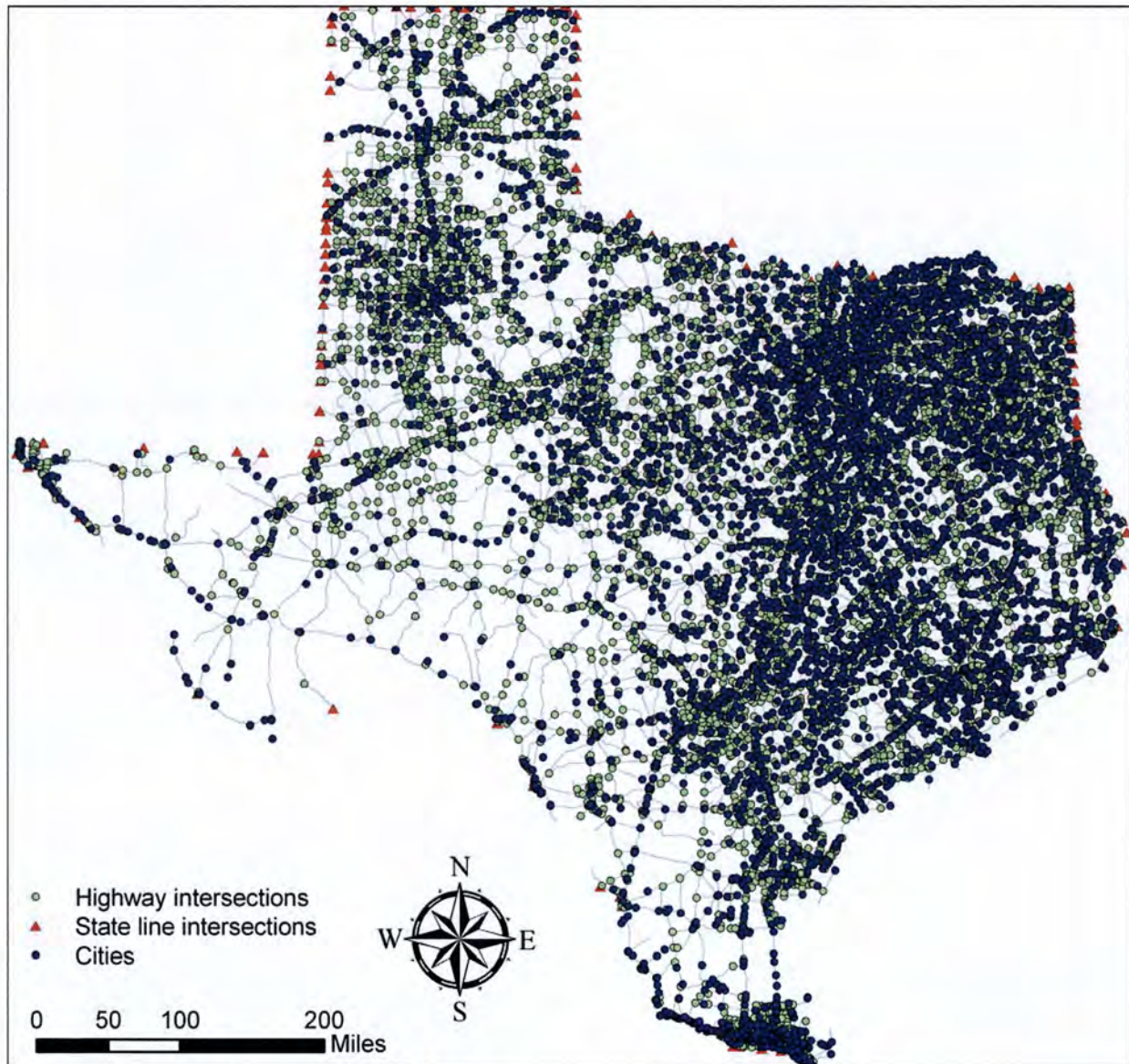

Figure 20. Final Junction Layer for GIS Route Reconstruction.

Generation of Route Shapefiles and Attribution

Researchers developed a route description parsing script using C#.NET to extract each of the intersections involved in a permit route sequentially into a new field. The researchers used “~” to separate two highways of an intersection and “;” to separate sequential intersections. At the end of this process, each route description was replaced in the form of a sequential list of intersections. Figure 21 is an example of a route description before and after this parsing, highlighting the changes to the record.

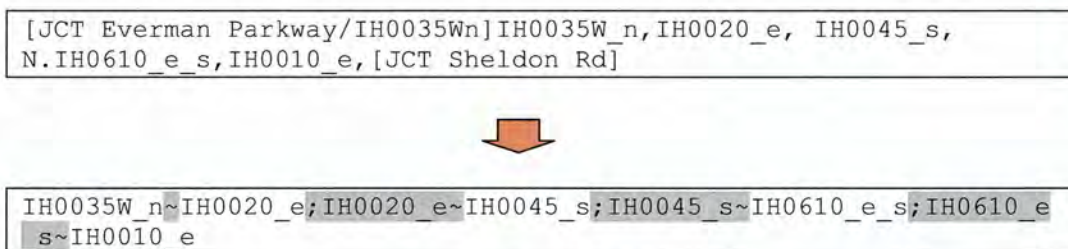

Figure 21. Route Description Before and After Intersection Parsing.

The researchers developed an automatic procedure consisting of three Visual Basic for Applications (VBA) programs to generate permit route features. For each permit route, the three VBA programs performed the following processes:

- Generate a point shapefile containing all intersections of the route.
- Create route segment between each pair of adjacent intersections and store them in a single layer file.
- Extract route segments from layer file and convert them into a single line feature.

Figure 22 further illustrates the three steps to generate a GIS route feature consisting of four line segments based on an actual route description starting in Dallas and ending in Houston.

Post Processing of Route Shapefiles

The GIS route processing resulted in 590,480 route features, each stored as a separate PolyLine shapefile. During GIS processing, a small number of processed route descriptions were not converted into route features due to a variety of reasons, such as the following:

- Extremely short routes.
- Routes with missing intersections.

The research team used an external program named GeoMerge to merge shapefiles (183). Using this program, the research team merged the large number of shapefiles into a few sizeable shapefiles. To facilitate GIS route analysis, the researchers imported these shapefiles into a file

geodatabase and separated the permit routes into feature classes based on permit year. Table 46 provides a summary of the GIS permit routes processed and stored in the file geodatabase.

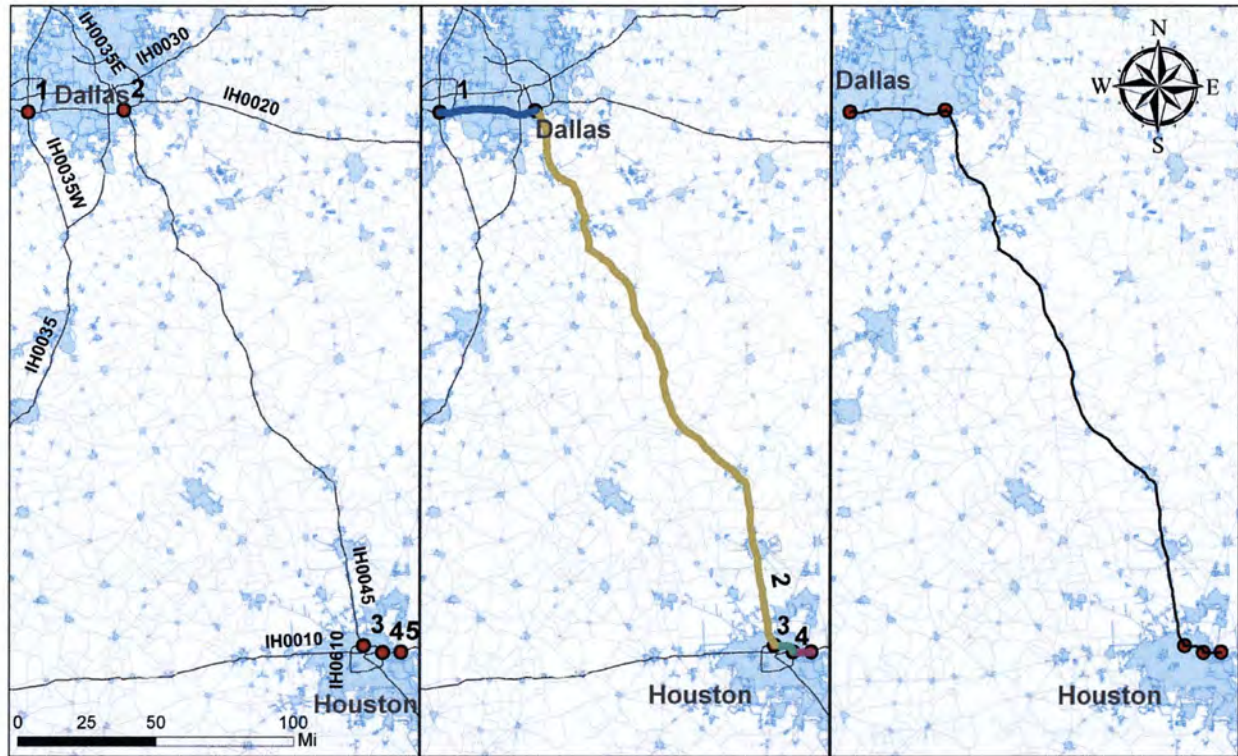

Figure 22. Three Steps of GIS Route Reconstruction (a: Point Shapefile Creation, b: Route Segment Creation, c: Conversion to Single Line Feature).

Table 46. Summary of Final Processed GIS Permit Routes.

| Fiscal Year | Total Original Permits | Number of Final GIS Routes | Number of Processed Permits | Percent of Total |
|--------------------|-------------------------------|-----------------------------------|------------------------------------|-------------------------|
| 2004 | 444,326 | 99,739 | 225,077 | 50.7% |
| 2005 | 447,876 | 79,723 | 170,464 | 38.1% |
| 2006 | 522,696 | 83,440 | 181,152 | 34.7% |
| 2007 | 554,198 | 86,123 | 186,024 | 33.6% |
| 2008 | 580,410 | 109,051 | 210,776 | 36.3% |
| 2009 | 527,447 | 134,011 | 254,452 | 48.2% |
| Total | 3,076,953 | 592,087 | 1,227,945 | 48.2% |

IDENTIFICATION OF CANDIDATE CASES FOR FORENSIC ANALYSIS

Introduction

The research team was tasked with the identification of cases where buried utilities were damaged by heavy or overweight vehicles, and select a number of cases for further in-depth analysis in the field. Guidance by the research oversight committee and various TxDOT officials provided that, while covering all utilities, the research team should prioritize water and sewer facilities within state right of way. These types of utilities frequently cross state routes, are generally large in diameter, and include some of the oldest utility installations that can be found in the Texas right of way today. Materials and structures that were installed many years ago can be particularly vulnerable and prone to damage due to material aging and outdated installation specifications. A collapse of a water or sewer line or their encasement has a potential to cause dramatic damage to pavement structure and impose hazards to the traveling public.

To identify potential cases for further analysis, the research team used a multi-prong approach, including a comprehensive literature review utilizing both online and offline sources, a request for information sent to a wide range of stakeholders, a review of Utility Installation Review System (UIR) data, telephone/email conversations with several TxDOT districts, and telephone interviews with various water and sewer utilities in cities where overweight loads are frequently routed.

These efforts resulted in a number of cases with damaged buried utilities. However, the research team was not able to confirm for any of these cases that the damage to the buried utility could be attributed to a heavy or overweight vehicle. The following is a description of the activities and findings of the research team related to the identification of cases with damage to buried utilities.

Literature Review

The research team performed a literature review of both online and offline sources including local newspapers, transportation research reports, relevant journals and magazines, and utility companies' websites. For the review of newspapers, the research team used the LexisNexis® Academic database available at the Texas A&M University libraries (184). This database is a comprehensive online information resource that contains a large collection of full-text current and archived articles from national and regional newspapers, wire services, broadcast transcripts, and international news. The researchers reviewed the news archives of a number of local newspapers in Texas, in particular newspapers that serve Texas cities with frequent overweight load traffic. The following are a sample of the newspapers included in the review:

- Houston Chronicle (185).
- Corpus Christi Caller-Times (186).
- San Antonio Express-News (187).
- Fort Worth Star-Telegram (188).
- Abilene Report News (189).

- Beaumont Enterprise (190).
- Port Arthur News (191).

The research team used the following keywords to find newspaper articles with descriptions of overweight vehicles that caused damage to buried utilities: “Buried,” “underground,” “utility,” “pipe,” “pipeline,” “damage,” “break,” “heavy,” “overweight,” “superload,” “truck,” “traffic,” etc.

Review of Underground Focus Magazine

The *Underground Focus Magazine* disseminates information about events of underground utility damages and new technologies related to underground utility infrastructure (192). As recommended by the research panel, the research team included this magazine in the literature review. Since the full contents of the magazine were not available, the research team reviewed the tables of contents of the last seven (2004–2010) years’ issues of the magazine that were made available online.

Also available at the magazine website was an underground utility accident database named *Accident File* (193). This database includes events of accidental damage to underground utility facilities in North America that were reported in newspapers. The records are grouped by state/province and were kept update until June 3, 2009. In the case of Texas, the database includes a number of records between 2006 and 2009 associated with buried gas, water/sewer, power, and communication utilities. The review of both *Underground Focus Magazine* and its *Accident File* did not provide any instance of a buried utility that was damaged by a heavy or overweight vehicle.

Outreach and Notification of Stakeholders

Upon approval of the project panel, the research team developed a letter to request cases of buried utility facilities damaged by heavy vehicle loads. The letter was sent to a large number of stakeholders across Texas whose contact information was obtained through sources such as TxDOT directory, previous research experience, and online directories of targeted public agencies and utility companies. The recipients included:

- 323 contacts at local public agencies and all 254 Texas Counties.
- 66 right of way and utility contacts at all 25 TxDOT districts and 4 regional support centers.
- 10 utility companies.
- 9 Texas utility and other relevant associations.
- 1 North Texas Toll Authority (NTTA).

About four months after dissemination of the letter, there had been only a limited number of responses and none of them was able to provide existing cases of underground utility damage

caused by heavy vehicle loads. The low responding rate could be partly due to the fact that the recipients were not aware of such cases.

Proactive Approach

Given the limited responses to the request letters, the research team took a more proactive approach by directly interviewing a number of stakeholders through telephone. As recommended by the project panel, this effort was primarily focused on TxDOT Beaumont, Corpus Christi, Fort Worth, and Houston Districts.

Review of Utility Installation Review System Data

The UIR system is a web-based system used by TxDOT to facilitate the processing and management of utility installation requests on the state right of way, also known as notices of proposed installations (NOPI) (194). Since it was first implemented in late 2005, TxDOT has expanded the system to several districts including Austin, Bryan, Fort Worth, Houston, Pharr, San Antonio, and Waco.

UIR stores in its database all information about a utility installation as included on the request, such as its location, date, utility type, and description. Among the utility permits, the research team was particularly interested in emergency repair requests or emergency work authorizations, which are submitted by utility owners upon an emergent utility facility failure. At the time of this analysis, the UIR database included 24,419 permits, including active, approved, and closed permits. Of these permits, 683 permits pertained to emergency repair requests for buried utility facilities. The research team then queried the installation description field of these 683 permits for the use of the following keywords: “damage,” “break,” “load,” “crush,” “load,” “weight,” “excessive,” “vehicle,” “truck,” and “carrier.” The query was structured to mark a record if any of these keywords was used in the installation description field and returned 121 records. The researchers then reviewed the damage type of these 121 records and sorted them into potentially interesting and not interesting damage types. Table 47 shows the results of this analysis and lists the records by damage type.

Table 47. Emergency Repair Requests by Damage Type.

| Not of Interest | | Potentially of Interest | |
|------------------------------|-------------------|---|-------------------|
| Damage Type | Number of Permits | Damage Type | Number of Permits |
| Damage by TxDOT contractor | 5 | Utility facility failure, break, or leakage | 57 |
| Lightning | 2 | Unspecified damage | 39 |
| Other damage | 2 | Exposure, lack of cover, or washed out | 6 |
| Damage by utility contractor | 1 | Third party/vehicle accident | 5 |
| Boring accident | 1 | Crushed line | 1 |
| No damage | 1 | | |
| Total | 13 | Total | 108 |

The research team focused on the 108 records of potential interest, determined the utility type, and reviewed the installation description for the cause of the damage. Table 48 provides a summary of the utility type for the 108 records that had a potentially related damage type.

Table 48. Utility Type of Potentially Interesting Emergency Repair Request Records.

| Utility Type | Number of Permits |
|-----------------|-------------------|
| Water and Sewer | 53 |
| Communication | 46 |
| Gas | 4 |
| Other | 4 |
| Total | 108 |

Most records did not provide a cause of damage in the installation description, so the research team contacted the utility owners to find out the causes of damages. This effort allowed the research team to determine that none of the 108 emergency repairs was a result of damage that was caused by a heavy vehicle load.

Contacts to TxDOT Districts and Water Utilities

The research team first contacted the TxDOT district maintenance directors. Upon contact, some of them requested their maintenance supervisors to assist with the research. Then, the researchers interviewed the water/sewer departments of several major cities in these districts. In many cases, the researchers were able to talk with their senior crew members who had relatively rich experience in utility facility maintenance. However, none of them was aware of cases involving utility damages by heavy vehicle loads. A city utility official noted a possible water line damage caused by heavy vehicle loads driving off-roads (e.g., on ditches or other places

where the depth of cover is shallow), yet he could not provide any further information about the incident and was not sure if it occurred on state right of way. The interviewed water/sewer utilities included:

- City of Beaumont Water Utilities Department.
- City of Port Arthur Water Utilities Department.
- City of Corpus Christi Water Department.
- City of Kingsville Water Department.
- City of Houston Department of Public Works and Engineering.
- City of Texas City Utilities Department.
- City of Big Spring Utility Maintenance Department.
- Trinity River Authority (Northern Region).

Among the utilities listed above, the City of Big Spring was not located within the four selected districts. However, the project panel recommended this historic city due to a combination of factors. The city is located at the intersection of IH20, US87, SH176, SH350, and the Missouri Pacific railroad. It has been one of the major transportation hubs for heavy or super-heavy vehicle loads generated by the ongoing wind industry boom in the region. On the other hand, many of the water/sewer lines in the area were installed decades ago, and the aged facilities can be vulnerable to those loads. Figure 23 shows the TxDOT districts and utility companies the research team contacted.

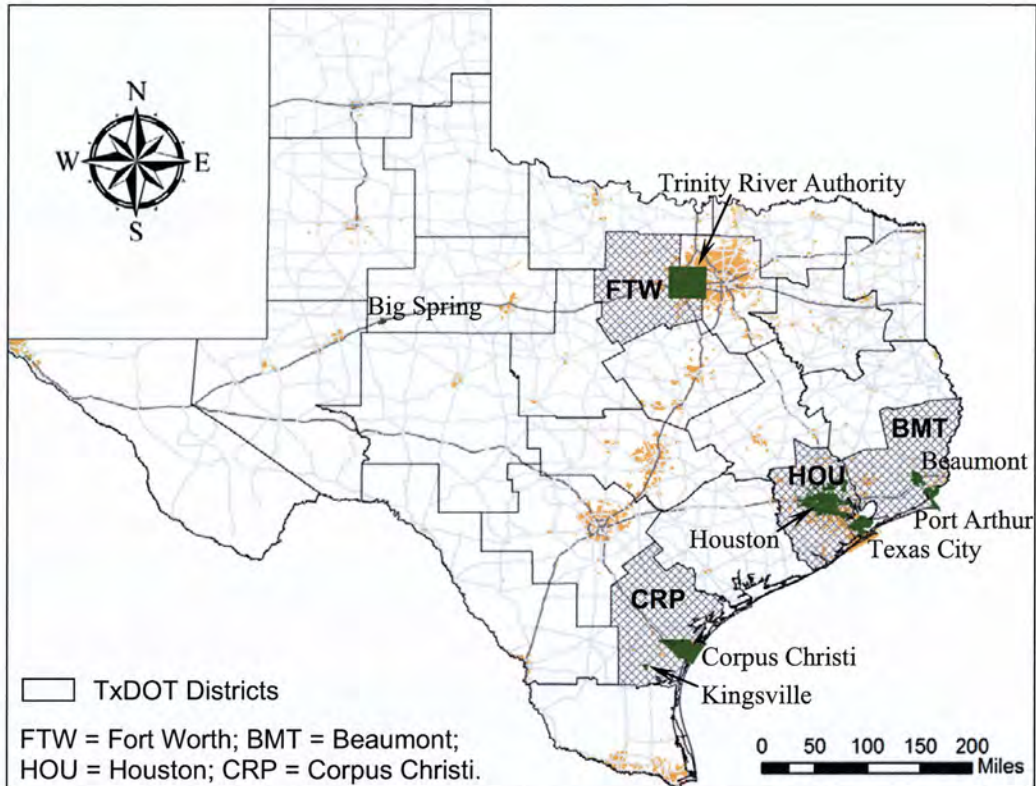

Figure 23. TxDOT Districts and Water Utilities TTI Contacted.

Regardless of the thorough efforts devoted, the research team was unable to identify any cases of underground utility facilities damaged by heavy vehicle loads. For a lack of cases, the research team did not carry out any forensic field investigations.

SENSITIVITY ANALYSIS OF DAMAGES TO BURIED UTILITY STRUCTURES

Introduction

In a proactive approach to identify critical parameters that affect buried utility structures, the research team conducted a sensitivity analysis. The objective of this task is (a) to determine characteristics of potential damage, (b) to compare with field data as available, (c) to develop a risk matrix, and (d) to use as guidance for Phase 2 damage evaluation.

Risk Analysis Framework

To assess the potential risk of damages to underground utility facilities, the research team developed a risk analysis framework including risk areas and risk factors as shown in Table 49.

Table 49. Risk Areas and Factors of Preliminary Risk Analysis Framework.

| Risk Area | Risk Factor |
|---------------------|--|
| Overweight vehicles | Gross vehicle weight Axle loads Tire sets Tire type and pressure Frequency of travel |
| Pavement | Type Structure/depth Integrity/age |
| Soils | Type |
| Buried utilities | Depth Age Material Diameter Location <ul style="list-style-type: none"> • Near roadbed • Crossing (angle) Casing (y/n, material) |

In Table 49, risk areas are a grouping of risk factors by common subject. The researchers used the risk factors as variables for input in the following sensitivity analysis (see Table 52, Table 53, and Table 68).

Tools for Sensitivity Analysis

The research team reviewed available tools to conduct the sensitivity analysis. Below is a summary of the tools reviewed by researchers.

Iowa Formula

In 1941, Spangler developed the original Iowa Formula to calculate the horizontal deflection of a buried flexible pipe structure, combining the elastic ring theory and fill-load hypothesis based on the stress distribution (10). Since its original development, revisions were made by Watkins and Spangler in 1958, and Masada in 2000 to come up with the vertical deflection calculation (11, 12). The modified form is the most widely used in practice for buried pipe design. During this review, the research team incorporated the modified Iowa formula in a Microsoft Excel spreadsheet program to perform calculations of vertical pipe deflections as a function of load magnitude, soil compaction, and pipe geometric and material properties.

2D Finite Element Programs

CANDE, an acronym for Culvert ANalysis and DEsign, is a 2D finite element program developed for the structural design, analysis, and evaluation of buried structures including culverts, underground storage facilities, and storm water chambers (195). CANDE was

originally developed by Katona and Smith in 1976 and recently upgraded for analysis and LRFD design of buried structures by Mlynarski et al. in 2008 (196, 195). The research team obtained an executable copy of the program, studied the program, and ran it on selected problems to learn how CANDE may be used for the sensitivity analysis.

During this learning stage, the research team identified a couple of limitations with respect to using CANDE for this purpose:

- The program does not permit simulation of multiple axles to realistically model truck geometries seen on roadways.
- CANDE does not have an automated mesh generation utility, which makes the program harder to use in a sensitivity analysis where geometric conditions such as depth of cover of pipe and pavement layer thickness need to be varied to identify critical conditions.

Another 2D finite element program, which the research team has used in previous projects, is PLAXIS, an acronym for PLasticity AXISymmetric, is a program that is particularly suited for geotechnical structure design and analysis. PLAXIS was used in the National Cooperative Highway Research Program (NCHRP) 647 study to recommend design specifications for live load distribution on buried structures (197). Due to its flexibility in modeling multiple axles and its automated mesh generation capability, researchers made the decision to use PLAXIS for the sensitivity analysis in Phase I of this project. However, there is still the limitation in modeling out-of-plane loads, which is inherent in a 2D finite element analysis. This limitation is handled by using an equivalent load magnitude and geometry to model out-of-plane loads in the 2D analysis.

3D Finite Element Program

Three-dimensional finite element programs have recently been utilized in several research projects to simulate highway and airport pavement response to truck and aircraft traffic loads. These programs offer the most versatility in realistically modeling complicated load configurations. However, application of these programs call for advanced skills in generating the 3D finite element mesh, and applying the appropriate boundary conditions. Three-dimensional finite element programs also require much longer computer running times compared to 2D analysis that is more widely used due to its simplicity. The research team is planning to utilize a 3D finite element program in Phase 2 of this project to perform a limited verification of the 2D analysis results with respect to assessing the risk of damage to buried utility structures subject to superheavy load moves.

Setup of Sensitivity Analysis

Prior to conducting sensitivity analysis using the PLAXIS 2D finite element program, the research team made an attempt to verify its applicability by comparing the program predictions with available field data collected from previous studies. The first verification was made using field data from the experimental program conducted by Watkins and Reeve in 1982 to determine the live load deflection of plastic pipe as a function of soil cover and soil compaction (198). They installed a 24-in. corrugated plastic pipe within sandy clayey silt at 1 to 3 ft depths of cover,

and at compacted backfill densities ranging from 75 to 95 percent of AASHTO T 99. Watkins and Reeve applied an H-20 truck load, simulated by a John Deere tractor (16 kips per wheel for a 32-kip axle load) on the buried pipes and measured the pipe deflections under loading.

Figure 24 compares the test measurements with the predictions from PLAXIS. Overall, the predicted deflections, expressed as percentages of the corresponding nominal pipe diameters, are observed to show good correspondence with the measured values. There is one point (at 1 ft depth of cover and 75 percent soil compaction) where PLAXIS over-predicted the measured deflection by about 0.6 percent. However, for this case, both the prediction and measured value identify a critical condition where the vertical deflection is above the 5 percent tolerance normally allowed in practice.

The trend indicated that the vertical deflection significantly decreased from 1 to 2 ft depth of cover especially in soil compacted at 75 percent of AASHTO T 99. The modified Iowa formula generally overestimated the deflections (at 95 percent soil compaction) compared to test measurements and PLAXIS predictions. The other verification was made using field data taken by Arockiasamy et al. in 2006 (199). In this previous project, researchers installed a 36-in. HDPE 6 ft below the surface, in backfill soil classified as poorly graded sand with silt (SP-SM) compacted at 95 percent of AASHTO standard compaction. Two tandem dump trucks were used to simulate the two-lane traffic. The axle load of each truck was 34.6 kips.

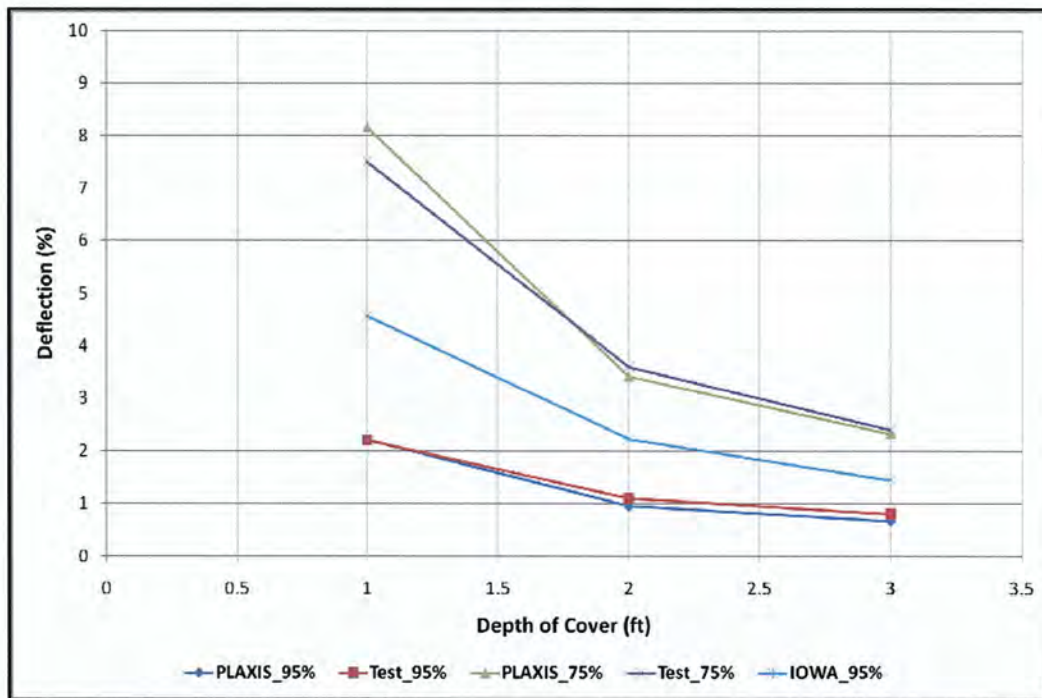

Figure 24. PLAXIS Verification with Field Data from Watkins and Reeve (198).

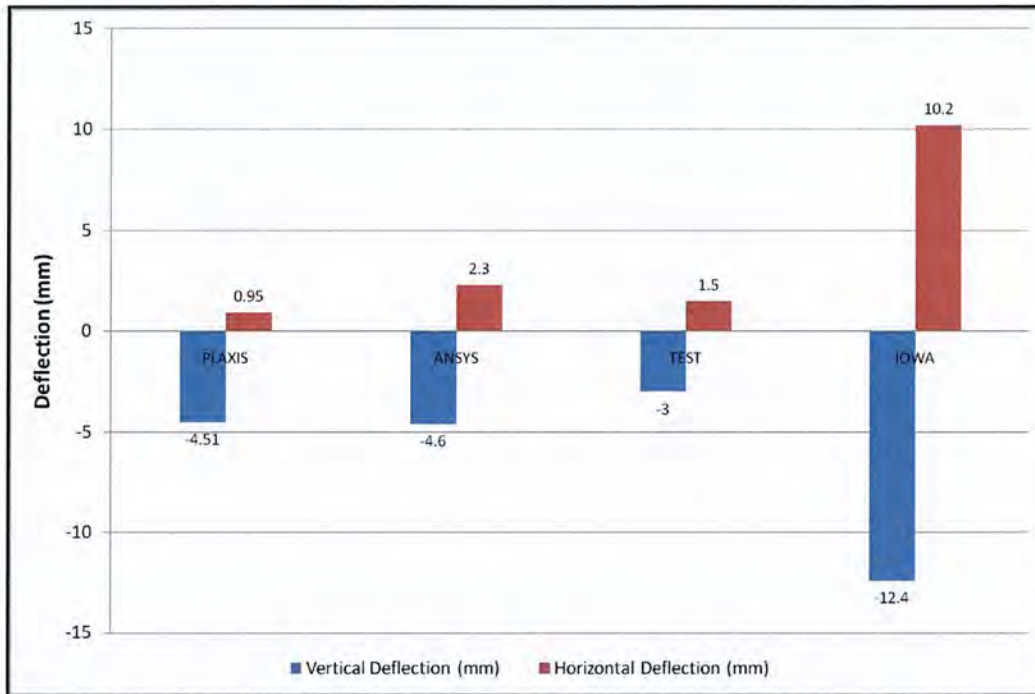

Figure 25. PLAXIS Verification with Field Data from Arockiasamy et al. (199).

Figure 25 compares the predicted vertical pipe deflections with the test measurements. In their project, Arockiasamy et al. used the Analysis System (ANSYS) 3D finite element program to predict the pipe deflections under loading. In this current project, TTI researchers used PLAXIS to predict the vertical deflections. Figure 25 shows that the ANSYS and PLAXIS predictions are generally comparable to each other and to the test measurements. The predicted radial deflection from PLAXIS is smaller than the ANSYS prediction and the test measurement. However, this difference is not considered significant in practice. Again, the modified Iowa formula exhibited significantly conservative predictions compared to the other values. This observation, along with the similar finding from the project done by Watkins and Reeve, indicate that current design procedures based on the modified Iowa formula are rather conservative.

Based on the results from the above verification, the research team decided to proceed with the sensitivity analysis using PLAXIS as the analysis tool. Table 51, Table 52, and Table 53 show the levels of the analysis variables selected by the researchers for this evaluation, based on the literature review conducted during this project. Axle weights chosen for this analysis corresponded to standard axle weights used for the design of bridges as provided by the TxDOT Bridge Design Manual (200). Until 2007, TxDOT used design loads provided by the AASHTO Standard Specifications for Highway Bridges (201). Starting in October 2007, TxDOT used the LRFD design methodology described in the AASHTO Load and Resistance Factor Bridge Design Specification, which is now in its 5th edition (202). For the purpose of this research, the research team used axle weights based on the AASHTO Standard Specification for Highway Bridges that describes loads based on hypothetical standard (HS) trucks with different axle and gross weights.

Table 50. Axle and Gross Weight of Three-Axle HS-Trucks (201).

| HS Truck | Axle Weight (lb) | | | Gross Weight | Comment |
|----------|----------------------|----------------------|----------------------|--------------|--|
| | 1 st Axle | 2 nd Axle | 3 rd Axle | | |
| HS-20 | 8,000 | 32,000 | 32,000 | 72,000 | TxDOT standard load for bridges before 2007. Minimum for all Texas bridges on all highway systems. |
| HS-25 | 10,000 | 40,000 | 40,000 | 90,000 | TxDOT standard for select heavy-use bridges before 2007, e.g., some bridges in Texas-Mexico border area. |
| HS-30 | 12,000 | 48,000 | 48,000 | 108,000 | |

Table 51. Variables Considered in Sensitivity Analysis.

| Variable | Range |
|---------------------------------|---|
| Axle weight (kips) ^a | 32, 40, and 48 |
| Number of axles | 1, 3, 5, 7, and 9 |
| Depth of cover (ft) | 1, 1.5, 2, 3, and 6 |
| Pipe material | PVC, Ductile iron, and Clay pipe |
| Pavement type | Non-paved (6" base + backfill material + clay subgrade) |
| Backfill soil type | SW (well graded or gravelly sand) |
| Backfill soil compaction | 85, 90, 95% based on AASHTO standard compaction |

^a Corresponds to HS-20, HS-25, and HS-30 design loads.

Table 52. Material Properties of Pipe.

| Type | Nominal diameter (in.) | Outer diameter (in.) | Inner diameter (in.) | Wall thickness (in.) | EA ^a (lb/in.) | EI ^a (lb in. ² /in.) |
|----------------|------------------------|----------------------|----------------------|----------------------|--------------------------|--|
| PVC | 24 | 24.8 | 22.5 | 0.71 | 284,400 | 11,981 |
| Ductile Iron | 24 | 25.8 | 24.7 | 0.37 | 8,880,000 | 101,306 |
| Vitrified Clay | 24 | 25.5 | 21.0 | 2.25 | 13,050,000 | 5,505,304 |

^a These properties are given per linear foot of pipe.

Table 53. Parameters for Mohr-Coulomb Model of Backfill Material.

| Soil Type ^a | Modulus of Elasticity (psi) | Poisson's ratio | Angle of friction (deg) | Dilatation angle (deg) | Cohesion (psi) |
|------------------------|-----------------------------|-----------------|-------------------------|------------------------|----------------|
| SW95 | 4100 | 0.29 | 48.0 | 18.0 | 0.001 |
| SW90 | 3100 | 0.25 | 43.0 | 13.0 | 0.001 |
| SW85 | 2100 | 0.21 | 38.0 | 8.0 | 0.001 |

^a Well-graded sandy backfill (SW) at corresponding compacted densities of 95, 90, and 85%.

Results of the Sensitivity Analysis

Axle Position

The researchers varied the pipe position to investigate the sensitivity of pipe vertical deflection to the axle position as shown in Figure 26. For the 2D PLAXIS analysis, researchers converted the axle weight load to an equivalent strip load using the procedure from the NCHRP 647 study. Five axles, each weighing 48 kips and at 4-ft axle spacing, were imposed on the pavement surface. The 48-kip axle weight is based on the HS 30 design truck configuration. The pavement structure in this analysis comprised 6 in. of flexible base over SW85 backfill material over clay subgrade. Researchers selected this pavement structure since an unpaved surface represents a more critical condition relative to pipe design compared to a paved surface with a stabilized stiffer material. The 24-in. PVC pipe was positioned 2 ft below the top of the base layer.

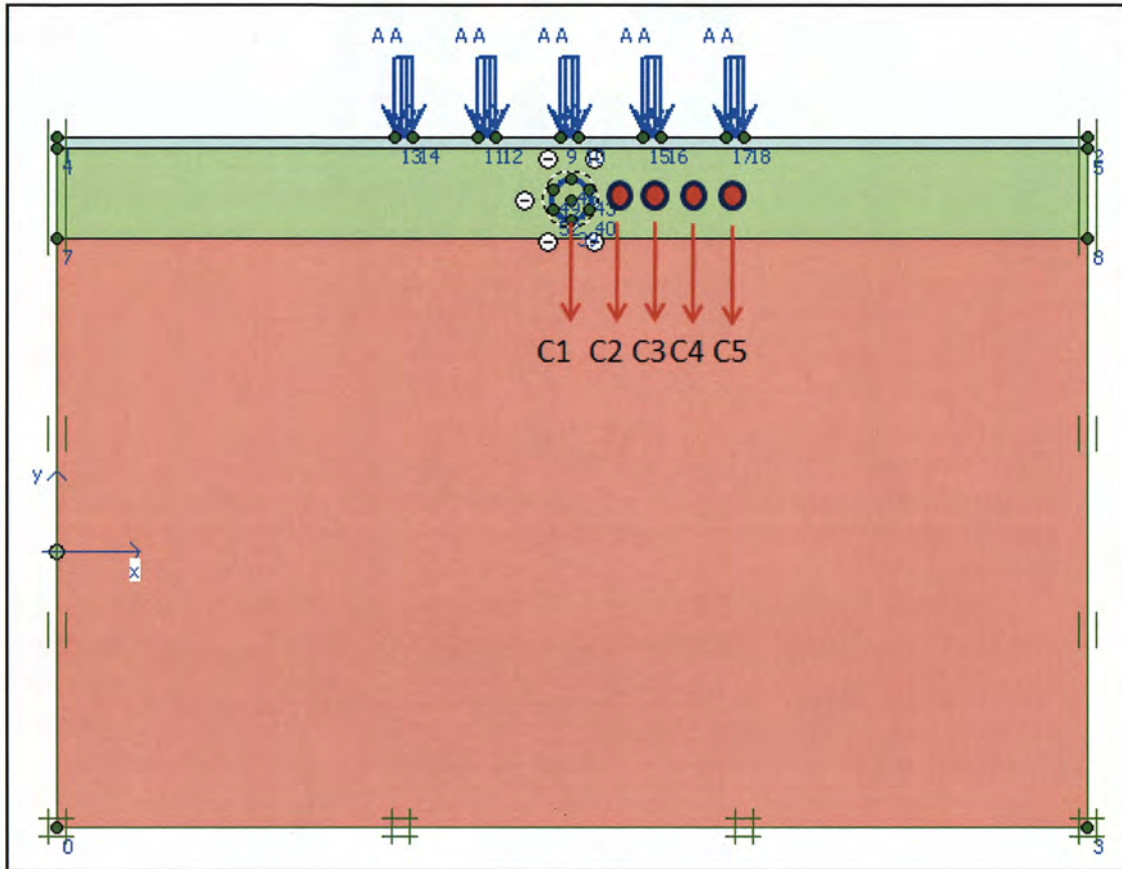

Figure 26. Varied Axle Positions with Respect to Pipe.

As shown in Figure 27, the maximum damage ratio is obtained when the axles are positioned symmetrically with respect to the pipe (denoted by C1). This result is logical since the pipe is expected to detect all axle loads at this position resulting in the most severe case based on pipe vertical deflection. The damage ratio in this sensitivity analysis is defined as the ratio of percent pipe vertical deflection to the 5 percent deflection criterion that is typically adopted in design practice. A damage ratio over 1 indicates the pipe deformed vertically above the 5 percent tolerance. Based on this result, researchers positioned the axles symmetrically with respect to the pipe to take into account the most severe condition.

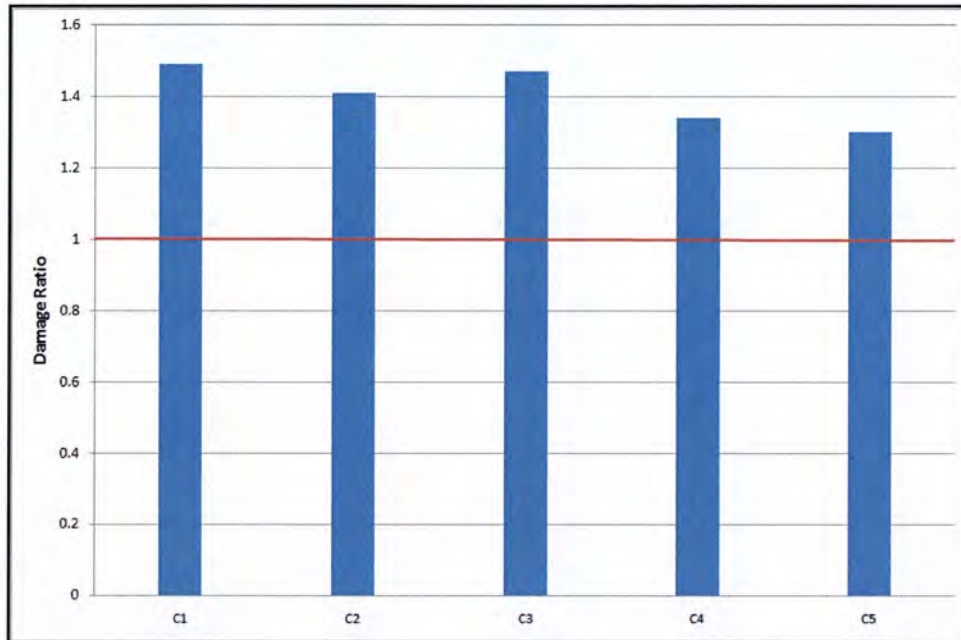

Figure 27. Sensitivity of Damage Ratio to the Axle Position.

Axle Weight

To investigate the sensitivity of pipe vertical deflection to the axle weight, researchers predicted the vertical deflections corresponding to the three levels of axle weight given in Table 51. The axle weights selected correspond to the three HS truck configurations typically considered in pipe design. The same pavement structure (2 ft depth of cover) and axle configuration (5 axles with 4-ft spacing) were used in evaluating the effect of axle weight. Figure 28 shows the results of this analysis. As expected, higher axle weight results in larger damage ratio. Based on this finding, researchers used a 48-kip axle weight in evaluating the effects of the other variables that are presented in the following sections.

Number of Axles

Researchers also investigated the effect of multiple axles on the predicted response of buried utilities to surface loads. For this investigation, researchers predicted the vertical deflections for different numbers of HS-30 design axle weights. Researchers assumed the same pavement structure used in the previous analyses except that the pipe was positioned at 1.5-ft depth of cover. This depth is the shallowest depth stipulated in existing Texas utility accommodation rules.

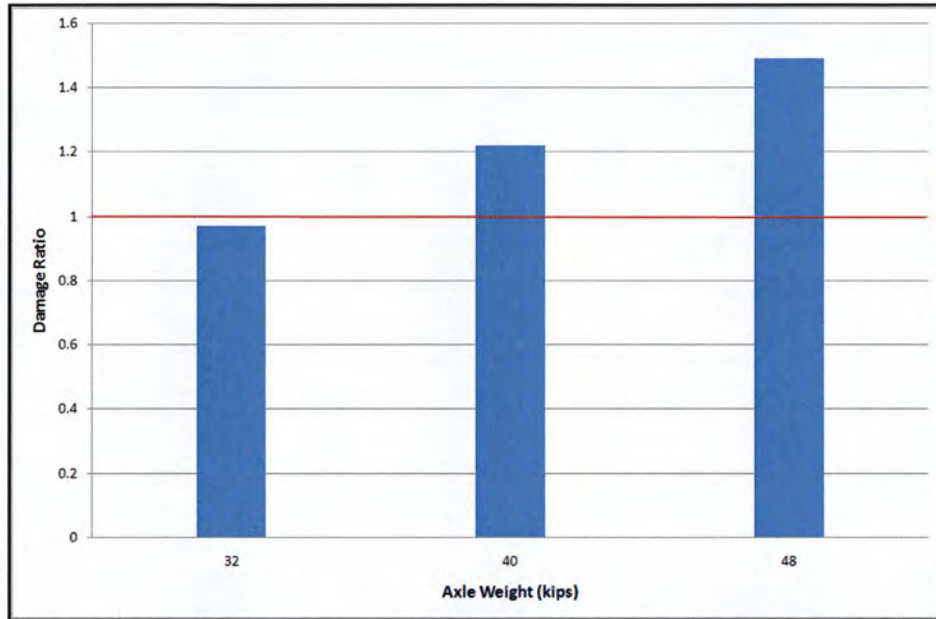

Figure 28. Sensitivity of Damage Ratio to the Axle Weight.

As expected, the damage ratio increased with the number of axles, as shown in Figure 29. The largest increase in the damage ratio occurs when the number of axles was changed from one to three. Figure 29 shows that multiple axles of transport vehicles used on some superheavy load moves need to be considered in estimating the damage potential associated with these moves. Based on the results shown in Figure 29, researchers modeled 9 axles in the remainder of the sensitivity analysis presented herein.

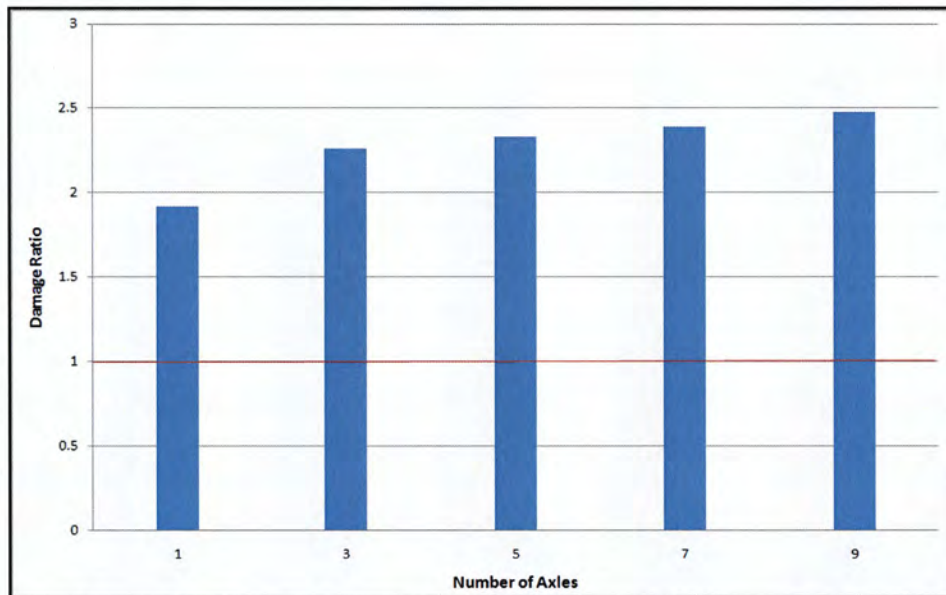

Figure 29. Sensitivity of Damage Ratio to Number of Axles.

Depth of Cover

Five levels of depth of cover (see Table 3) were considered in this analysis. These levels covered the range of depths found from the review of existing specifications. Figure 30 shows the sensitivity of the damage ratio to the depth of cover—the shallower the pipe, the higher the predicted vertical pipe deflection and damage ratio. For the assumptions used in this analysis, which correspond to a critical condition involving 9 axles at 48 kips per axle, 85 percent compaction of backfill, and unpaved surface with just 6 in. of base, the analysis suggests a minimum 3 ft depth of cover to satisfy the 5 percent deflection tolerance typically specified in pipe design. The minimum 3-ft depth of cover is also adopted in practice based on the public works design manual of the City of North Richland Hills and the construction standards of the City of Grapevine. This information was obtained from previous contacts made by the research team with departments of public works.

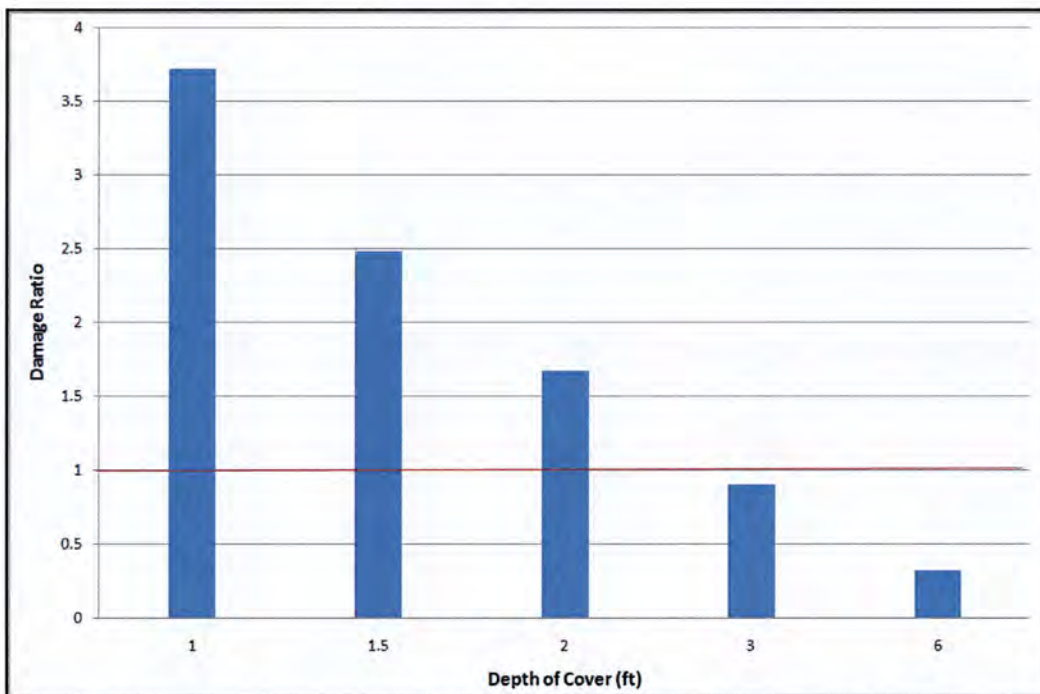

Figure 30. Sensitivity of Damage Ratio to the Depth of Cover.

Pipe Material and Wall Thickness

Three different types of pipe materials were considered. For the comparisons, researchers assumed the same nominal pipe diameter of 24 in., positioned at 2-ft depth from the unpaved surface and subjected to nine HS-30 design axle loads. Figure 31 shows the effect of pipe material on the predicted vertical deflections. For the assumptions used, the predicted damage ratio decreased as the pipe material changed from PVC to ductile iron to vitrified clay. In this analysis, the pipe wall thickness varied between pipe materials according to the design tables used in existing specifications (for the given 24-in. pipe size and pressure rating).

Researchers also considered the effect of pipe wall thickness (assuming the same pipe material and nominal diameter size) to simulate the effect of aging on the predicted pipe vertical

deflection. In this analysis, researchers considered ductile iron pipe, and modeled the effect of potential thinning of the pipe wall due to corrosion as a result of chemical reactions over time. Figure 32 shows a slightly higher damage ratio with thinner wall thickness. Overall, the results presented in Figure 31 and Figure 32 indicate less sensitivity of the damage ratio to the pipe material and wall thickness compared to the effects of other factors considered in this sensitivity analysis.

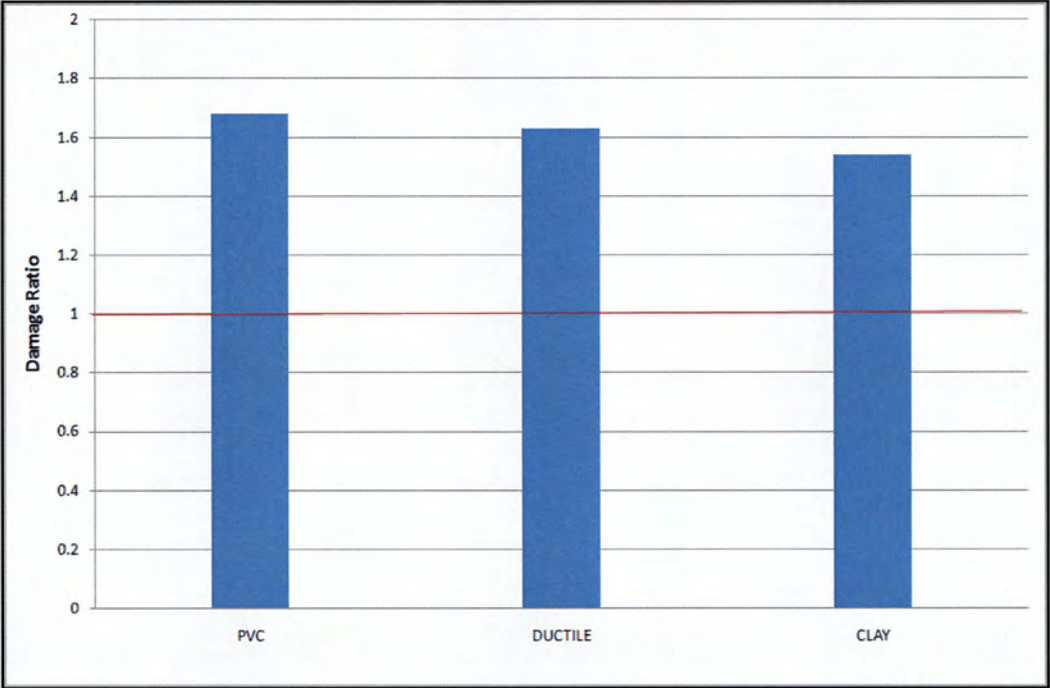

Figure 31. Sensitivity of Damage Ratio to the Pipe Material.

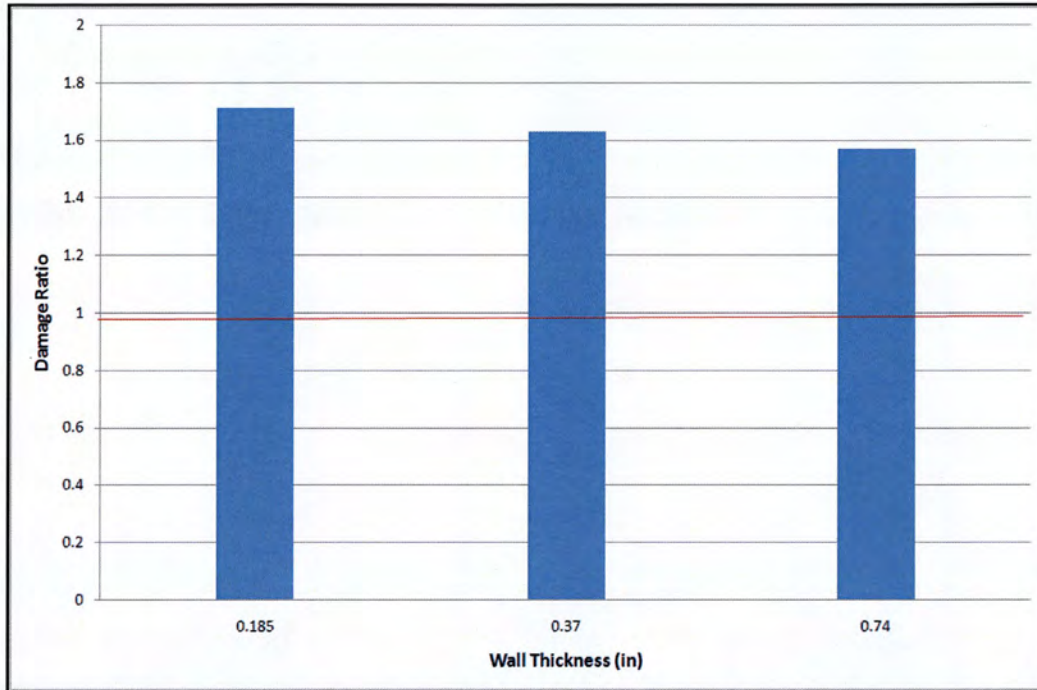

Figure 32. Sensitivity of Damage Ratio to the Pipe Wall Thickness.

Backfill Soil Type

The sensitivity analysis also considered different levels of compaction for the backfill material within which the pipe is buried. Table 53 shows the material properties assumed in this analysis. Researchers predicted the vertical deflections of a 24-in. PVC pipe at 2 ft depth of cover within the same pavement structure, and subjected to the same nine HS-30 design axle loads used in the earlier analyses. As expected, Figure 33 shows a higher damage ratio with lower compaction.

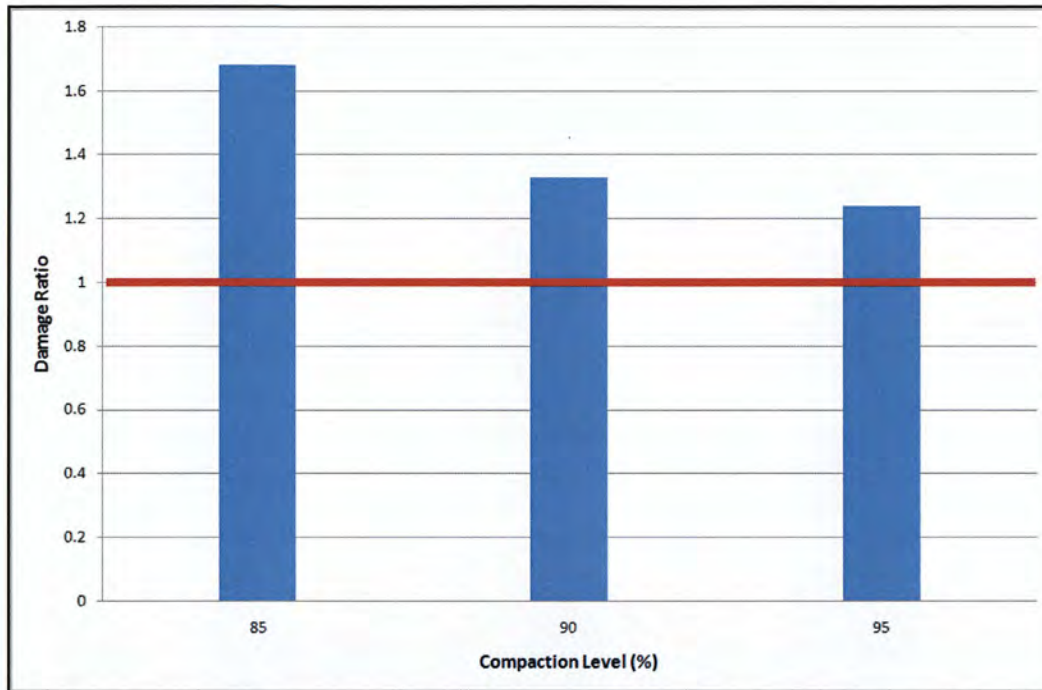

Figure 33. Sensitivity of Damage Ratio to the Compaction Level.

Summary of the Sensitivity Analysis

Based on the results presented, researchers noted the following findings from the sensitivity analysis:

- **Analysis Reliability and Calibration.** The predicted displacements using the PLAXIS 2D finite element program showed reasonable agreement with field test values taken from two previous studies.
- **Axle Positions.** Axles positioned symmetrically about the pipe produced a maximum damage ratio based on predicted vertical displacements.
- **Axle Loads.** Higher axle load along with larger number of axles resulted in a higher damage ratio.
- **Depth of Cover.** Depth of cover showed the most significant influence to the predicted damage ratio.
- **Pipe Material.** The pipe material and wall thickness also influenced the damage ratio but its effect is relatively small compared to the effects of depth of cover, number of axles, and axle load magnitude.
- **Backfill Compaction.** Low compaction level of backfill material exhibited higher damage ratio.

Analysis Limitations

Researchers note that the sensitivity analysis assumed static loading conditions to predict the pipe deflections under varying conditions. The research team recommends that the fatigue behavior associated with repetitive loads should be investigated in the laboratory during Phase 2 of this project.

In addition, while the effect of multiple axles was considered based on typical HS-20, HS-25, and HS-30 truck load configurations used in current pipe design methods, the effect of multiple tires on multiple axles found on some of the transport vehicles used on superheavy load moves was only approximately modeled. For this reason, researchers recommend additional analysis using a 3D finite element program to directly model the load configurations found on multi-wheel superheavy load trailers. This analysis will supplement the findings presented from the sensitivity analysis using PLAXIS.

CHAPTER 6. PHASE 2 UTILITY DAMAGE EVALUATION

INTRODUCTION

This chapter summarizes the findings of the Phase 2 Utility Damage Evaluation. The purpose of this task was to perform laboratory testing of buried pipes and 3D finite element method (FEM) simulations to assess potential damage from repeat overweight load traffic on buried utilities, to assess the adequacy of the existing Texas UAR (138).

In the proposal, researchers noted that the direction and scope of the Phase 2 Utility Damage Evaluation would largely depend on the findings from Phase 1, particularly with respect to findings from reviewing the historical evolution of the UAR and design standards for buried utilities, as well as evaluations of candidate case study sites to investigate the impact of overweight loads on utilities buried within the right of way. The general finding from the Phase 1 analysis suggested that current design standards appear to be adequate. This finding was supported by the outcome of the outreach effort that did not identify any incidents of damage to buried utilities within the right of way associated with overweight load traffic. However, the Phase 1 analysis only focused on specific static loading conditions and did not evaluate the effects of repeat overweight loading on buried utilities. The Phase 2 analysis addressed the issue of repeat overweight loads on buried utilities by conducting a series of laboratory tests and supplemental sensitivity analyses. Specifically, Task 7 included the following two subtasks:

- **Subtask 1: Perform Laboratory Testing of Buried Pipes.** The research team conducted testing on buried pipes including several fatigue tests.
- **Subtask 2: Supplemental Phase 1 Sensitivity Analysis of Damages to Buried Utility Structures with Finite Element Analyses.** The research team evaluated the effect of multi-tire axle configurations on a buried utility using a 3D finite element program.

The following provides a detailed description of the activities of the research team for the subtasks outlined above.

LABORATORY TESTING OF BURIED PIPES

Introduction

The purpose of the laboratory testing was to identify the effects of repeated heavy loads on buried utilities as compared to the static load conditions in Phase 1. To prepare for the testing, researchers conducted a limited literature search of research and testing in the area of buried utility facilities. The following are two examples of this review:

- Faragher et al. conducted a full-scale field test to examine the behavior of buried plastic pipes, which were repeatedly subjected to heavy load vehicles driven along an overlying haul road (203). The research team recorded the vertical deformation of the pipes throughout the test for up to 1000 load passes. It was observed that the vertical deformation increased rapidly during the initial loading cycles but tended to flatten out or

asymptote with further load cycles. Based on field test results, a power curve was developed that was found to effectively correlate with the test data.

- Gondle and Siriwardane conducted a study on the long-term performance of buried thermoplastic corrugated pipes by using the finite element method (204). They employed a creep model developed by Hashash (205) to simulate the behavior of corrugated high density polyethylene pipe (HDPE) for 50 years. The results indicated that most of the pipe deflection can be observed in the early stages after the installation of pipe. Results have shown that service life of 24-in. HDPE pipes can extend up to a period of 50 years for various fill heights when a 5 percent vertical change of diameter was assumed as a criterion.

Based on the literature review and the results of the sensitivity analysis conducted in Phase I, researchers conducted a laboratory test to investigate the fatigue behavior of buried pipes using a soil box system at the High-Bay Laboratory of The Texas A&M University. The following sections document in detail the steps and procedures of the laboratory testing.

Testing Configuration and Setup

The research team initially proposed to conduct six tests: two pipe materials (PVC and concrete) at three displacement levels. However, static load tests showed that the vertical displacements were much lower than 5 percent of the vertical pipe diameter for each pipe material, keeping depth of cover, soil material, and compaction level constant. Thus, the decision was made to use a fixed load level of 24 kips (corresponding to an HS-30 loading) instead of having three target levels of displacement.

Previous studies of buried utilities investigated the behavior of the pipe by applying a static load to a pipe buried in a soil box (206, 207). The advantage of utilizing a soil box is that it allows effective simulation of loads on the buried pipe under different conditions with respect to soil, load, and buried depth. Taking into account the need for repetitive load testing, limited time frame, and limited budget, the researchers found the use of a soil box test setup to be the most feasible option.

The research team purchased a used shipping container with the standard dimensions of 8 ft wide by 20 ft long by 8.5 ft high. The research team cut this container in half, closed the open end, and reinforced the sides using I-beams to fabricate a test box with the dimensions of 8 ft wide by 10 ft long by 8.5 ft high. The I-beam reinforcement was used to prevent bulging of the box walls due to applied load and induced soil pressure. Figure 34 shows a schematic of the soil box, including dimensions and direction of a test pipe.

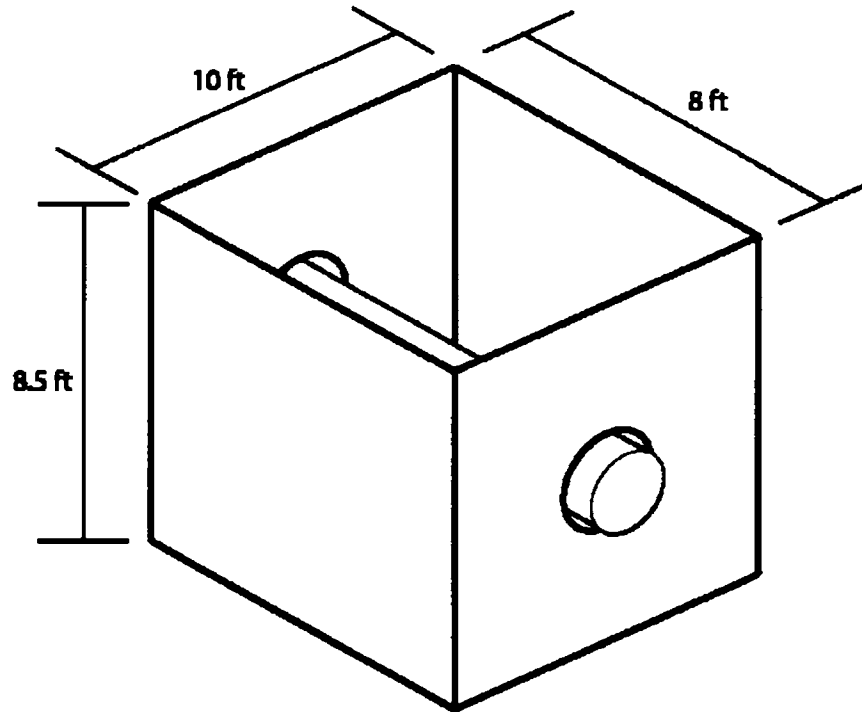

Figure 34. Dimensions of Soil Box and Direction of Test Pipe.

Testing Procedure

The following provides a brief overview of the steps to prepare the soil box and pipe specimens for testing. Following this overview, Figure 37 and Figure 38 provide illustrations of the steps taken for the preparation of the soil box test.

1. **Deposit Sand.** The first step involved the placement of sand into the soil box in two lifts up to about 6 in. below the side opening for the test pipe.
2. **Compact Sand.** After each lift of soil, the research team compacted the sand to maximum compaction level using a vibrator compactor. The target density for each lift of soil was 95 percent of the standard Proctor density, in accordance with the current practice for installation of underground utility structures in Texas.
3. **Measure Density and Moisture Content.** After completion of each lift, researchers measured in situ density and moisture content using a nuclear density gauge to check uniformity in preparation of soil layer. The research team measured density and moisture content of the sand in nine locations around the box as shown in Figure 35.
4. **Measure Soil Modulus.** The research team measured the soil modulus using a dynamic cone penetrometer (DCP).

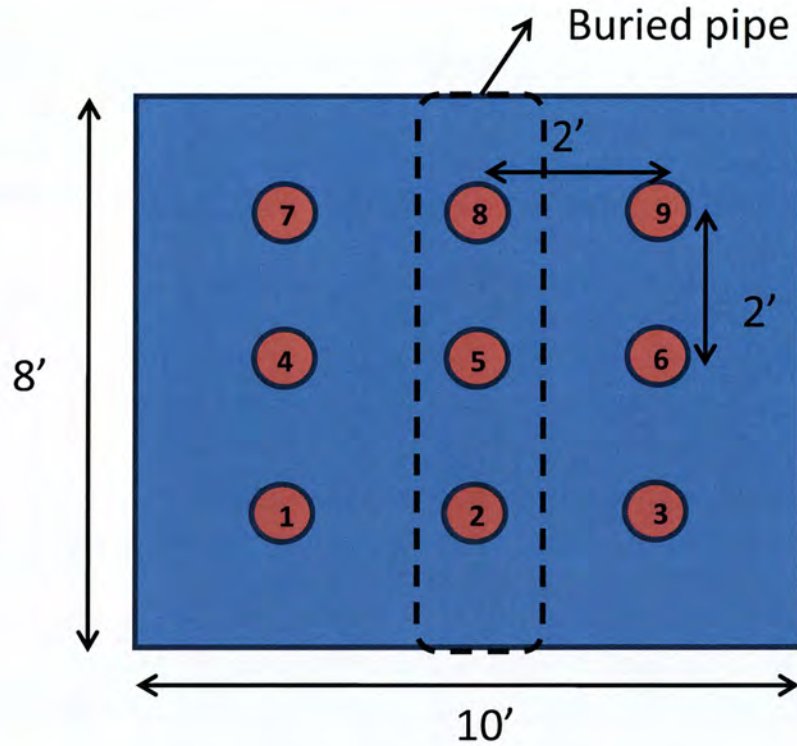

Figure 35. Nuclear Density Gauge Test Locations.

5. **Deposit Bedding Layer.** Researchers deposited 6 in. of gravel as bedding material for the test pipe. Researchers also added a lining around the pipe opening in the soil box to prevent soil from escaping the box during testing.
6. **Instrument and Install Pipe.** The research team instrumented the test pipe using strain gauges and linear variable differential transformers (LVDTs). The research team then placed the pipe through the side openings on top of the bedding material. The research team took care not to set the pipe on the bottom of the soil box opening.
7. **Backfill and Compact Sand.** The research team added sand to the box in two 9-in. lifts to produce a depth of cover of 1.5 ft over the top of the pipe. After each lift, the research team compacted the sand to 95 percent of the standard Proctor density. Figure 36 shows a graphic of the soil and gravel layers in the soil box.

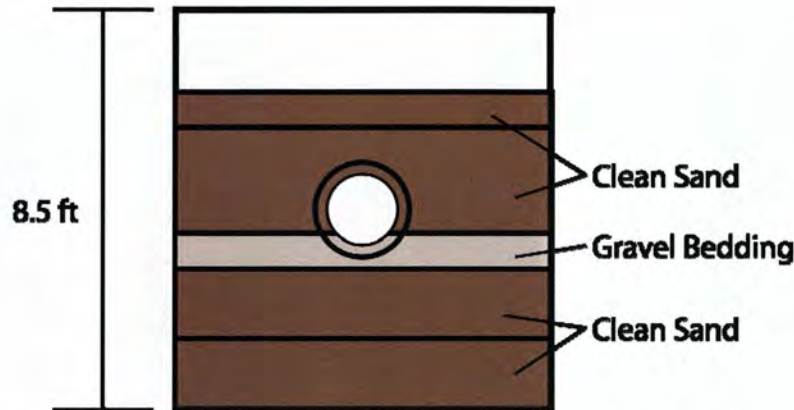

Figure 36. Cross Section of Soil Box with Soil Lifts.

8. **Measure Density and Moisture Content.** After completion of each lift, researchers again measured in situ density and moisture content in nine locations using a nuclear density gauge to check uniformity in preparation of soil layer.
9. **Measure Soil Modulus.** The research team measured the soil modulus using a dynamic cone penetrometer (DCP).
10. **Set Up Loading Frame and Plate.** Researchers positioned the loading frame in the middle of the soil box and placed a loading plate on the sand surface.
11. **Conduct Static Load Test.** Researchers conducted a static load test on the pipe test specimen to ensure that instrumented gauges were functioning properly, and to determine the test loading level that produces a 5 percent vertical pipe displacement (based on the pipe diameter) or up to 24 kips, whichever came first.
12. **Conduct Repetitive Load Test.** Researchers conducted a repetitive load test with up to 100,000 load repetitions.
13. **Conduct Parallel Plate Load Test.** Researchers conducted a parallel plate load test to determine pipe stiffness from the load displacement curve.



Step 1. Deposit sand.



Step 2. Compact sand lift.



Step 3. Measure density and moisture content.



Step 4. Measure soil modulus using DCP.



Step 5. Deposit gravel bedding layer.



Step 6. Install pipe after instrumentation.

Figure 37. Laboratory Setup of Soil Box Test (Steps 1–6).



Step 7. Backfilling with sand.



Step 8. Measure backfill density and moisture content.



Step 9. Measure backfill soil modulus.



Step 10. Set up loading frame and plate.



Step 11. Conduct static load test.



Step 12. Measure pipe deformation.

Figure 38. Laboratory Setup of Soil Box Test (Steps 7–12).

Results of the Density and Moisture Tests

Table 54 shows the results of the first pipe test using unjointed PVC pipe. For the following tests, the researchers left the first and second lifts undisturbed and compacted the soil above the pipe to similar levels as shown in Table 54. In Table 54, γ is the soil density measured in pounds per cubic feet, and W is measured gravimetric water content. For each lift, researchers also calculated the mean and coefficient of variation (COV) of the soil density and water content.

Table 54. Measurements of Density and Moisture Content.

| Location | First lift | | Second lift | | Third lift | | Final lift | |
|----------------|-------------------|-------------|-------------------|-------------|-------------------|-------------|-------------------|------------|
| | γ (pcf) | W (%) | γ (pcf) | W (%) | γ (pcf) | W (%) | γ (pcf) | W (%) |
| 1 | 113.4 | 4.7 | 110.3 | 4.0 | 110.6 | 5.1 | 111.1 | 3.5 |
| 2 | 114.6 | 4.2 | 109.8 | 3.6 | 111.7 | 5.0 | 107.8 | 3.6 |
| 3 | 112.0 | 4.4 | 111.4 | 4.1 | 112.3 | 3.5 | 111.2 | 3.6 |
| 4 | 110.5 | 5.1 | 113.9 | 4.0 | 111.3 | 4.4 | 110.1 | 3.9 |
| 5 | 113.2 | 4.2 | 109.1 | 3.7 | 111.3 | 4.5 | 107.8 | 3.4 |
| 6 | 113.0 | 4.4 | 110.5 | 4.2 | 112.2 | 4.4 | 112.3 | 3.3 |
| 7 | 114.5 | 5.1 | 110.8 | 5.0 | 109.3 | 4.5 | 111.2 | 4.2 |
| 8 | 114.9 | 4.2 | 109.4 | 4.1 | 111.9 | 4.2 | 111.6 | 3.8 |
| 9 | 111.6 | 3.7 | 104.1 | 5.2 | 112.6 | 4.3 | 110.2 | 3.6 |
| Mean | 113.1 | 4.4 | 109.9 | 4.2 | 111.5 | 4.4 | 110.4 | 3.7 |
| COV (%) | 1.3 | 10.3 | 2.4 | 12.9 | 0.9 | 10.5 | 1.4 | 7.5 |

The results indicate that each soil layer appears to be compacted uniformly as indicated by the COV values, which are below 3 percent with respect to the density and close to 10 percent with respect to the gravimetric water content.

Results of the Dynamic Cone Penetrometer Tests

Along with measuring density and moisture content, researchers conducted DCP tests to obtain the soil modulus at corresponding locations, shown in step 4 of Figure 37. The DCP test is widely used to estimate soil moduli from the DCPI penetration rate according to the following equation:

$$M_r = 2555 \left(\frac{292}{DCPI^{1.12}} \right)^{0.64} \quad (21)$$

where

M_r = resilient modulus in psi.
 DCPI = DCP index (penetration rate in mm/blow).

Equation (21) is provided as an option in the Mechanistic-Empirical Pavement Design Guide (M-E PDG) program for input of layer modulus when DCP data are available (208). Table 55 shows the test results of the DCP tests for the first pipe test using unjointed PVC pipe. Three DCP tests were conducted after the 1st, 2nd, and final lifts were placed.

Table 55. DCP Test Results.

| Location | First Lift | | Second Lift | | Final Lift | |
|----------------|-------------------|----------------|-------------------|----------------|-------------------|----------------|
| | DCPI (mm/blow) | M_r (psi) | DCPI (mm/blow) | M_r (psi) | DCPI (mm/blow) | M_r (psi) |
| 1 | 14.66 | 14107 | 17.04 | 12664 | 23.82 | 9960 |
| 2 | 16.00 | 13247 | 20.42 | 11123 | 26.66 | 9202 |
| 3 | 19.48 | 11505 | 18.40 | 11984 | 23.73 | 9988 |
| 4 | 15.13 | 13792 | 17.40 | 12474 | 20.00 | 11289 |
| 5 | 16.48 | 12970 | 24.00 | 9906 | 24.44 | 9777 |
| 6 | 16.08 | 13202 | 17.92 | 12215 | 23.18 | 10155 |
| 7 | 17.50 | 12423 | 18.86 | 11773 | 23.64 | 10015 |
| 8 | 14.07 | 14527 | 24.00 | 9906 | 32.20 | 8024 |
| 9 | 16.08 | 13200 | 21.67 | 10660 | 23.08 | 10186 |
| Mean | 16.16 | 13219 | 19.97 | 11412 | 24.53 | 9844 |
| COV (%) | 9.9 | 6.8 | 13.6 | 9.3 | 13.7 | 8.9 |

The test results indicate lightly higher moduli of the lower layer based on lower DCPI. Overall, the variation of calculated moduli value within about 10 percent is deemed acceptable. After preparation of backfill material was completed, researchers covered the material with a plastic sheet to prevent moisture loss during the test. For subsequent tests, the researchers conducted DCP tests for the final lift only, to minimize disturbances of the soil under the pipe test specimen.

Pipes Used for Testing

The research team started out by testing unjointed PVC pipe. Based on the results of these tests, the research team also tested jointed PVC pipe. For the test of concrete pipe, the research team decided to use jointed concrete pipe, which was weaker than unjointed concrete pipe, and therefore signified a worst case scenario. Table 56 shows the dimensions of the pipes the researchers used during the soil box testing.

Table 56. Properties of Pipes Tested.

| Material | PVC | PVC Jointed | Concrete Jointed |
|--------------------------------|------|-------------------|-------------------|
| Average Outside diameter (in.) | 18.5 | 18.5 ^a | 23.0 ^a |
| Average Inside diameter (in.) | 18.0 | 18.0 ^a | 20.4 ^a |
| Average Wall thickness (in.) | 0.5 | 0.5 ^a | 2.6 ^a |

^a Measured at unjointed part of the pipe.

To monitor deformation of the pipe, researchers instrumented the unjointed PVC pipe with eight strain gauges and two LVDTs in vertical and horizontal directions as shown in Figure 39 (a) and (b). The two strain gauges at each location were attached adjacently to obtain an average value of readings. For jointed PVC and concrete pipes, researchers installed vertical and longitudinal LVDTs to measure the deformation across the joint, as shown in Figure 39 (c).

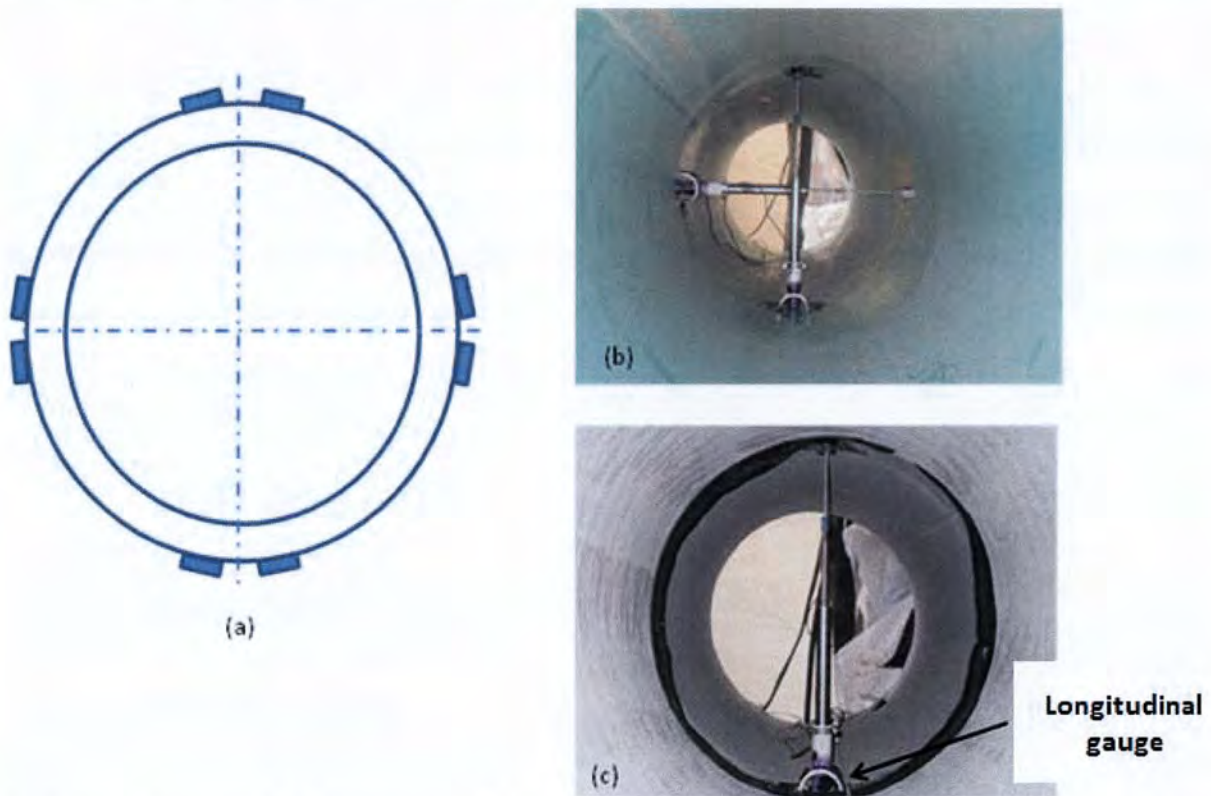

Figure 39. Layout of Instrumented Sensors: (a) 8 Strain Gauges for Unjointed PVC Pipe; (b) 2 LVDTs for Unjointed PVC Pipe; (c) Vertical and Longitudinal LVDTs for Jointed Concrete Pipe.

Fatigue and Static Load Testing

Researchers conducted both static and fatigue tests on three pipes: unjointed PVC, jointed PVC, and jointed concrete pipe. The researchers conducted the static test prior to performing the fatigue test to check the operation of instrumented gauges, and to determine the allowable loading level that would produce a 5 percent vertical pipe displacement based on the pipe diameter. However, researchers limited the maximum loading level to 24 kip (24,000 lbf), which corresponds to a wheel load of an HS-30 truck.

To apply the load, researchers used a 10 by 20 by 2 in. steel plate to simulate a dual tire configuration of HS trucks. The load was then applied over a 3 by 3 ft composite mat composed of three layers of plywood and a 1/8-in. metal sheet for a total thickness of 3 in. This mat was used to distribute the load through the soil layer, similar to a base layer of an actual pavement section.

After the static test, researchers conducted a fatigue test based on the loading level determined by the static load test. The cyclic load was applied up to 100,000 times. To determine the duration of the load per cycle, researchers ran a linear layered elastic program named BISAR (209) to compute the vertical displacement at 18 in. of depth for various lateral positions under a 12,000 lb circular load with a radius of 5.9 in. For this analysis, researchers used a one-layer system having 10 ksi of modulus and 0.4 Poisson's ratio. Figure 40 shows how the predicted vertical displacement at a point changes depending on the distance of the wheel load from that point. In this figure, the percent of vertical displacement is the ratio of the predicted displacement for a given load location to the maximum displacement, which is obtained when the load is directly above the evaluation point (i.e., at zero position). As the load moves from this position, the predicted vertical displacement at the evaluation point diminishes.

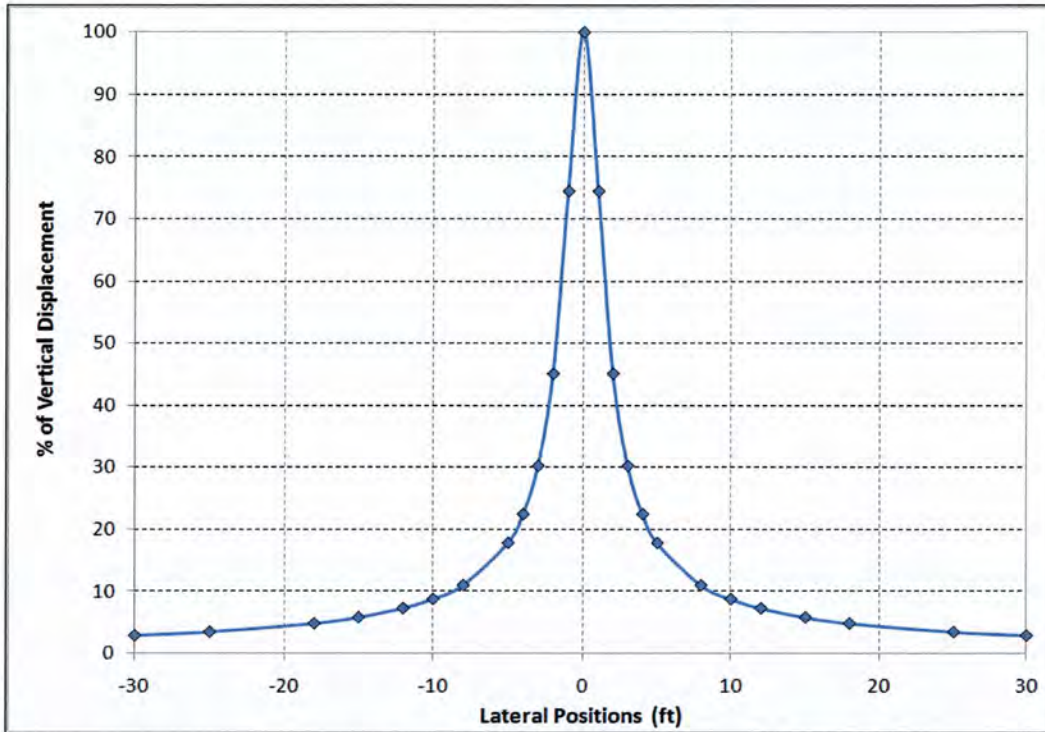

Figure 40. Vertical Displacement Reduction along the Lateral Position.

If we consider the pipe to be located at the zero lateral position, Figure 40 suggests that a 60-ft range centered about the zero position would cover the influence zone of the applied load. If we consider a wheel load moving at 12 mph (comparable with the speed of certain superheavy load moves), the loading time can be calculated as follows:

$$t = \frac{d}{v} = \frac{60 \text{ ft}}{17.6 \text{ ft/sec}} = 3.41 \text{ sec.} \quad (22)$$

In practice, the multiple axles on a superheavy load trailer are spaced about 4.5 to 5.0 ft apart. Therefore, considering superheavy load trailers with multiple axles and multiple tires per axle, it is deemed there is no unloading time based on the trend observed in Figure 40. Consequently, researchers made a decision on applying a continuous haversine load with a 3.5-second loading duration per cycle.

After fatigue testing, researchers conducted a parallel plate loading test on the unburied pipe specimens to determine pipe stiffness based on the load-displacement curve of the pipe itself. Researchers employed the test procedure in accordance with ASTM D-2412-02 “Standard Test Method for Determination of External Loading Characteristics of Plastic Pipe by Parallel-Plate Loading” (27). Six pipe specimens were considered as follows:

- Tested and untested unjointed PVC pipes.
- Tested and untested jointed PVC pipes.

- Tested and untested jointed concrete pipes.

Figure 41 illustrates the setup of the test. The length of tested pipe was 5 ft, and three steel I-beams were used as parallel plates to provide loading and support.



Figure 41. Parallel Plate Loading Test Setup.

Two LVDTs were installed to record vertical and horizontal displacements. With a loading rate of 0.45 in. per minute, the researchers increased the load to achieve a 5 percent vertical displacement, which corresponds to 0.9 in. for the 18-in. diameter pipe. For the concrete pipe, researchers reduced the loading rate to 0.05 in. per minute to avoid abrupt cracking failure, based on discussion with laboratory personnel and research staff.

Testing Results

Unjointed PVC Pipe

Researchers processed static load test data as shown in Figure 42. The displacement was calculated by subtracting the initial displacement from the displacements measured at each loading level. The maximum displacement at 24 kips was 0.11 in. vertically and 0.075 in. horizontally. The maximum measured vertical displacement is much lower than the 5 percent criterion of 0.9 in. Given this result, researchers applied a 24-kips fatigue load up to 100,000 cycles, with a 3.5-second loading duration per cycle.

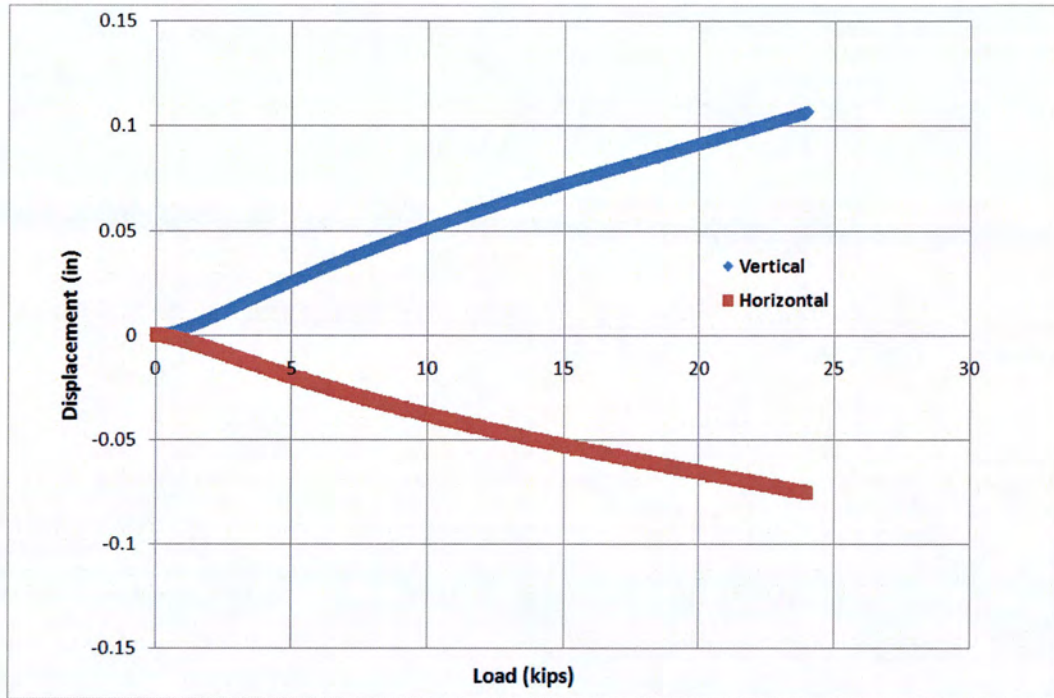

Figure 42. Static Test Result of Unjointed PVC Pipe.

Figure 43 and Figure 44 show the example traces of displacements and strains measured by LVDTs and strain gauges during the fatigue load test. As noted, all instrumented sensors functioned properly during the test.

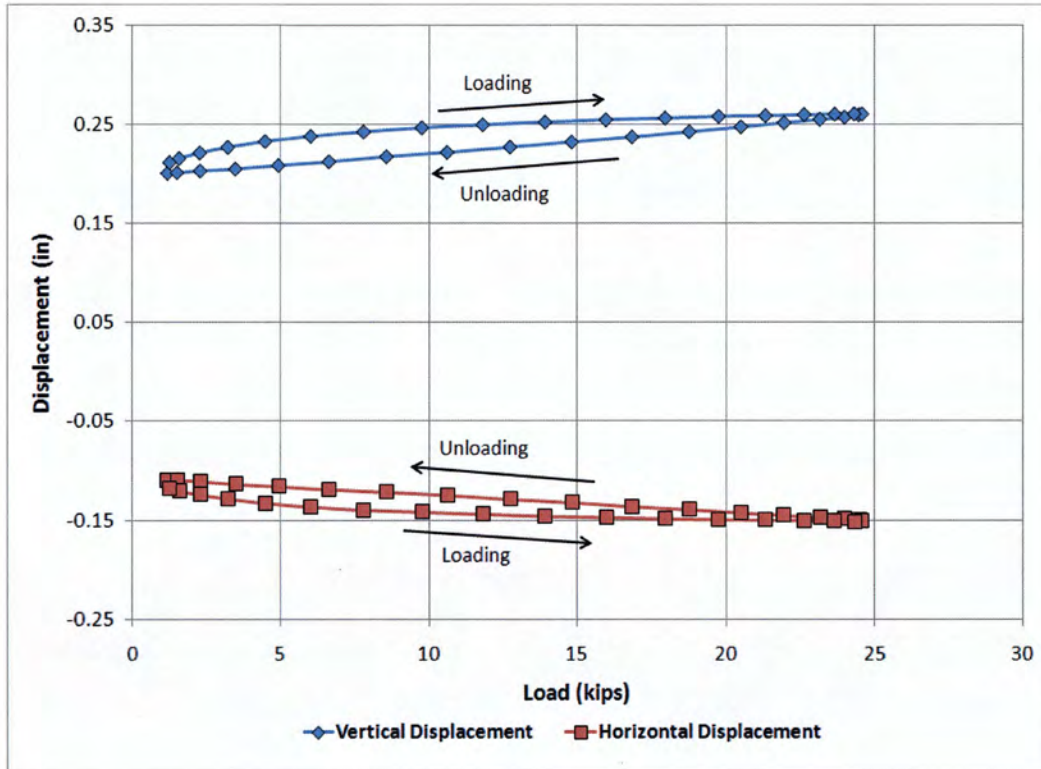

Figure 43. Variation of Displacement versus Load.

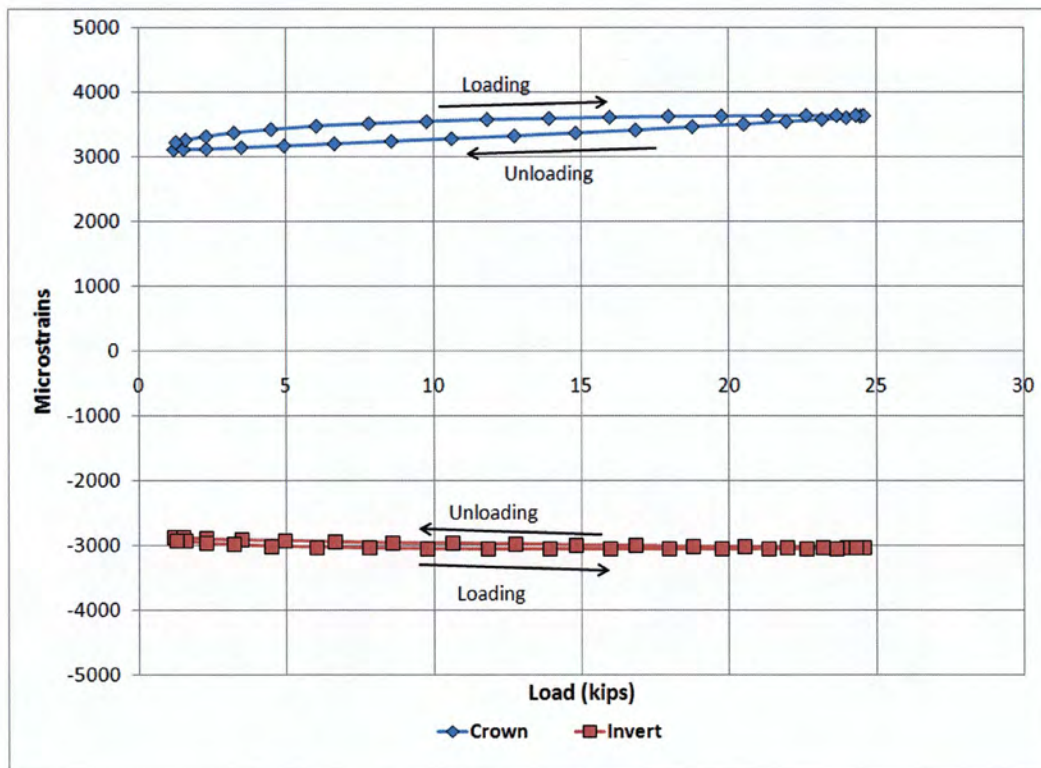

Figure 44. Variation of Strains versus Load.

Researchers calculated the total displacement by subtracting initial displacement from the maximum displacements measured from each loading cycle as shown in Figure 45. It was found that the vertical and horizontal total displacements decreased in early stages of loading applications, up to approximately 2000 load cycles. This might be attributed to the backfill material undergoing further compaction during the first 2000 loading cycles. After 2000 load cycles, once soil confinement reached stable condition, the total displacement began to gradually increase in both directions. However, the total vertical displacement of about 0.08 in. after 100,000 load cycles is much lower than the 5 percent criterion of 0.9 in.

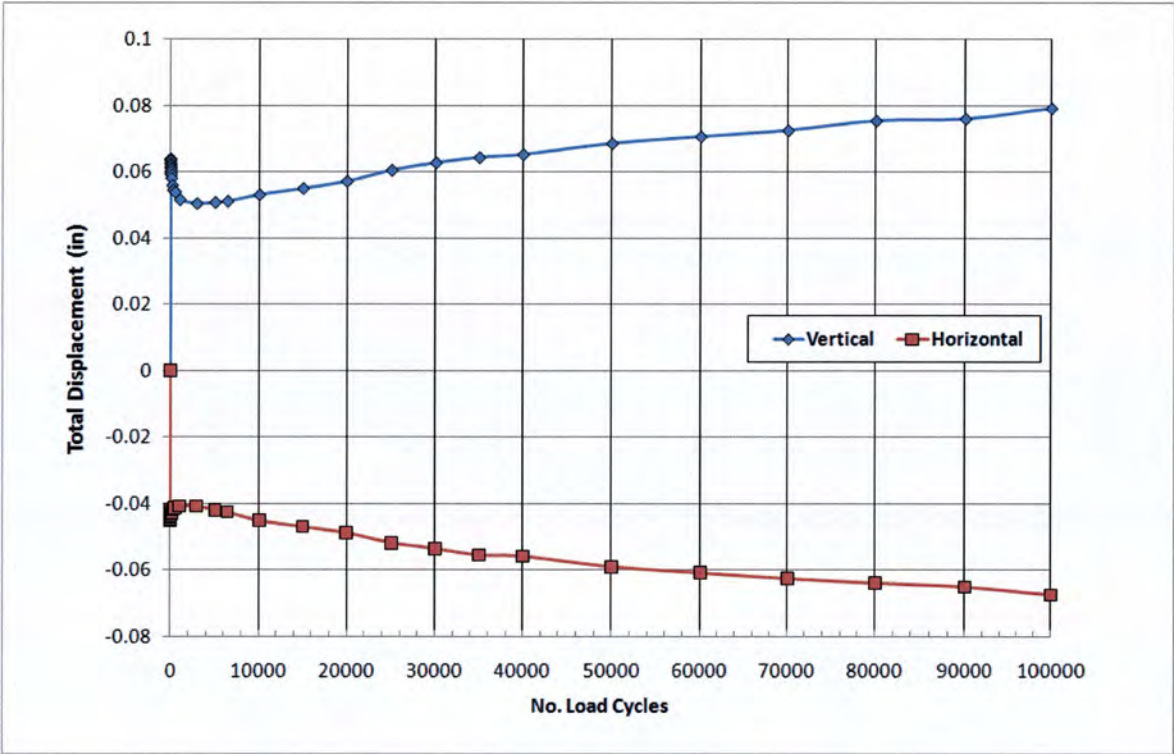

Figure 45. Total Vertical and Horizontal Displacement by Number of Load Cycles (Unjointed PVC Pipe).

Researchers also plotted the strains to verify the behavior of the pipe shown in Figure 45. The strain data shown in Figure 46 also exhibited a similar trend particularly in the strain values measured at the crown of the pipe.

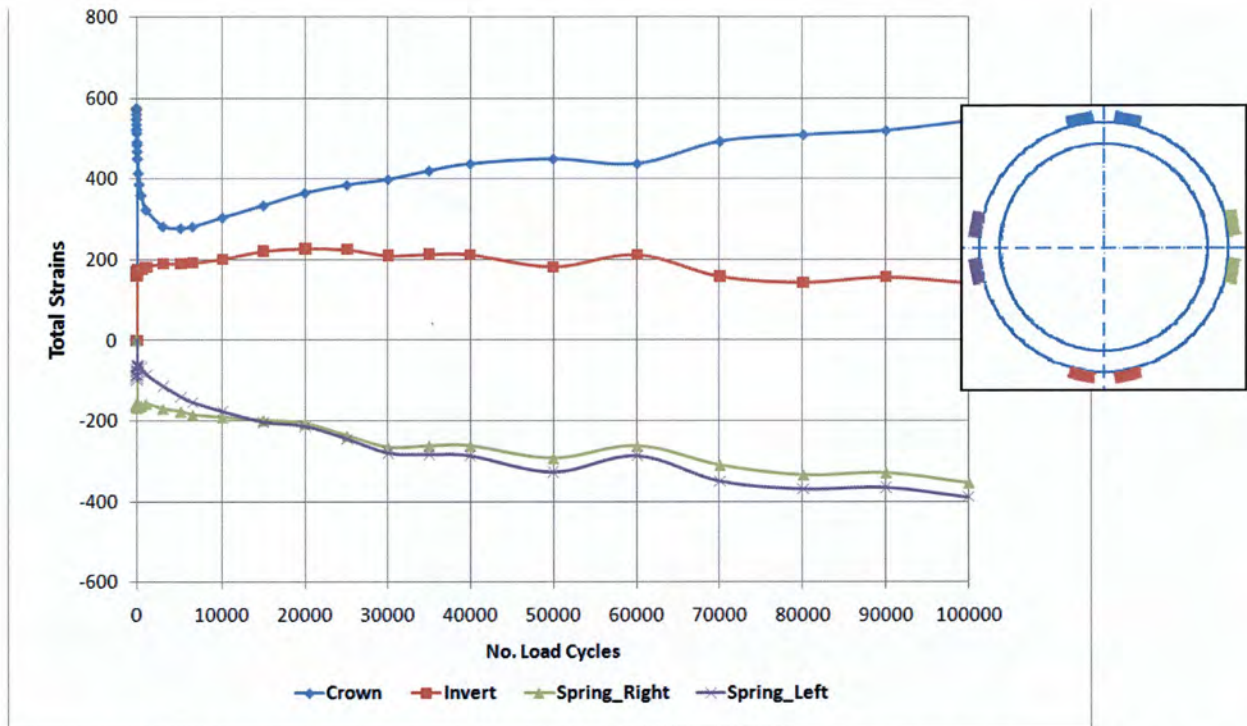

Figure 46. Total Strains versus Number of Load Cycles of Unjointed PVC Pipe. (Pipe Cross Section Shows Color Code of Strain Gauges.)

Researchers conducted a visual inspection after fatigue testing as illustrated in Figure 47. This figure shows that the loaded area underwent further settlement due to repeated load applications that might be associated with the observed decrease in total displacements during the early stage of the fatigue test. In addition, no visible damage was observed on the pipe tested.



Figure 47. Visual Inspection after Fatigue Test of Unjointed PVC Pipe.

Researchers conducted a parallel plate test to investigate the change of pipe stiffness as compared to a new and untested PVC pipe. The pipe stiffness PS was computed using the following equation:

$$PS = F / \Delta y \quad (23)$$

where

- PS = pipe stiffness (lbf/in./in.).
- F = force per unit length.
- Δy = vertical displacement.

Figure 48 shows the load-displacement curves obtained from the tests. At a given load, the pipe that underwent fatigue testing yielded a slightly larger displacement than the untested pipe, resulting in lower pipe stiffness.

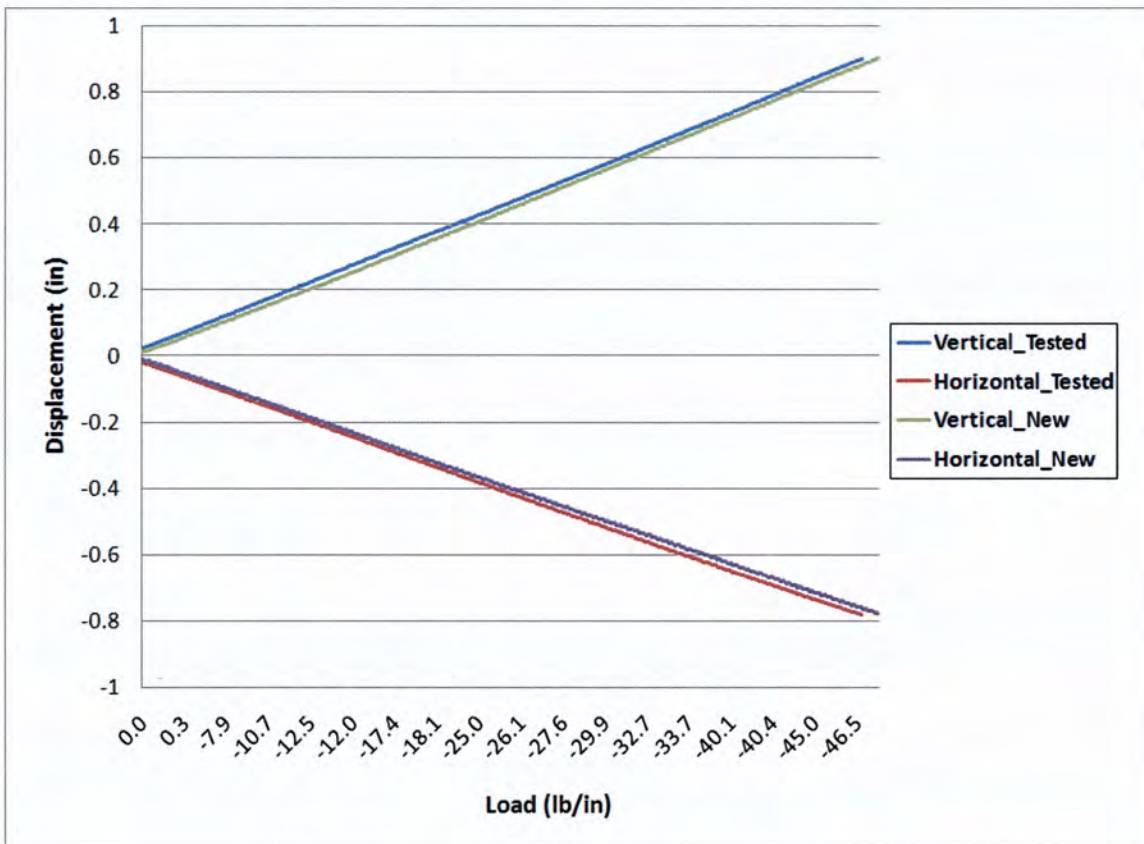

Figure 48. Load-Displacement Curves of Unjointed PVC Pipes from Parallel Plate Test.

The pipe stiffness of the tested pipe was determined to be 48 psi compared to 54 psi for the untested pipe, a reduction of about 11 percent. The measured pipe stiffness is deemed reasonable based on the SDR 35 pipe specification that requires a minimum pipe stiffness of 46 psi (210). Even though the research team did not detect any visual damage, the pipe material appears to have experienced a reduction in material stiffness, assuming that both PVC pipe

specimens came from the same lot. The researchers conducted a numerical analysis to estimate the effect of degradation of pipe modulus on long-term behavior in Subtask 2.

Jointed PVC Pipe

After the first set of testing using unjointed PVC pipe, the research team decided to perform a similar test on a jointed pipe, which is likely to deform in a more pronounced manner due to joint opening behavior. The same test procedure described above was followed for the jointed PVC pipe test. During test preparation, researchers conducted DCP and nuclear density gauge tests to ensure that the condition of the backfill soil would be comparable to the previous static and fatigue loading test. Figure 49 shows the result of the static loading test. Note that a longitudinal gauge was installed along the inside bottom of the pipe to monitor deformation across the joint instead of a horizontal LVDT.

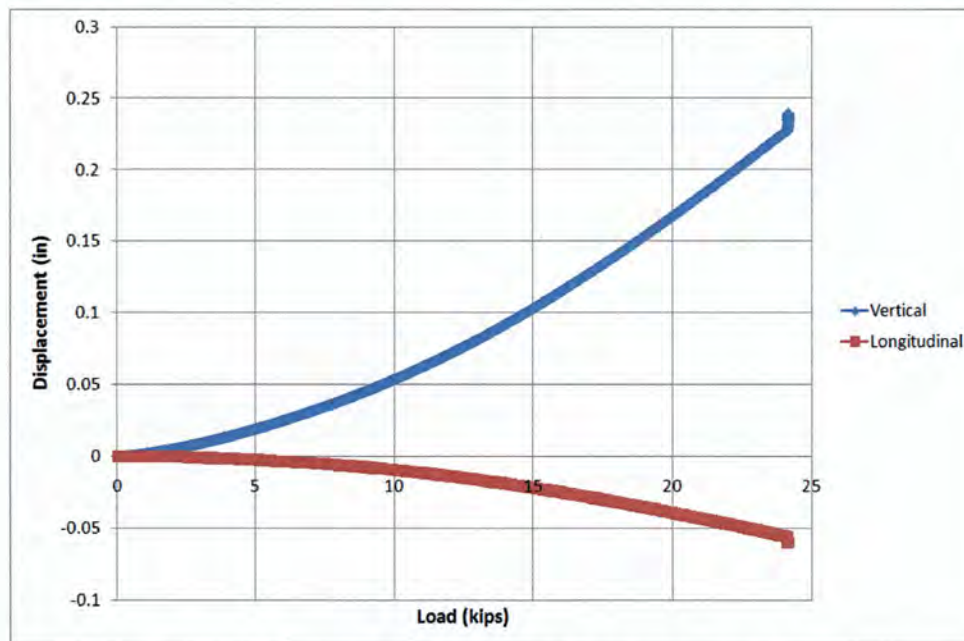

Figure 49. Static Test Result of Jointed PVC Pipe.

The maximum vertical displacement of the pipe was 0.24 in. Compared to the static load test for unjointed PVC pipe shown in Figure 42, this value is more than twice that of the unjointed PVC pipe, but still well below the limit of 0.9 in. in pipe vertical diameter reduction. Simultaneously, the longitudinal gauge at the joint provided a maximum joint opening of 0.06 in.

Researchers conducted a fatigue loading test based on identical loading condition as adopted for the unjointed PVC pipe test. Unlike the unjointed PVC pipe behavior shown in Figure 45, the total displacements of jointed PVC pipe rapidly increased at the early stage of the fatigue test. As shown in Figure 50, the rate of increase in total displacement in the first 2000 cycles is high but began to level off with further load repetitions.

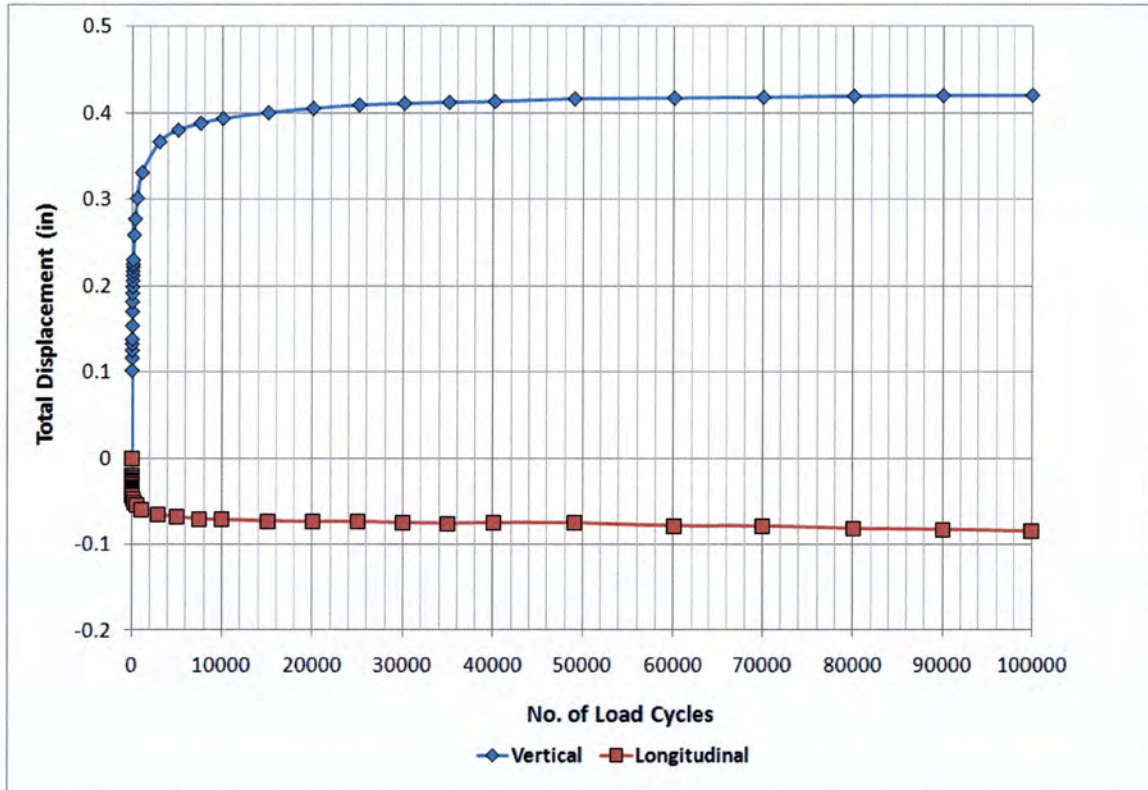

Figure 50. Total Displacement versus Number of Load Cycles of Jointed PVC Pipe.

The final total displacements were 0.42 in. vertical and 0.09 in. in the longitudinal direction. However, the level of total vertical displacement is acceptable based on the 5 percent (0.9 in.) vertical pipe diameter reduction criterion as shown in Figure 51.

After fatigue testing, a visual inspection was conducted, as illustrated in Figure 52. The loaded area exhibited an indication of soil densification, similar to what was observed after the unjointed PVC pipe test. Researchers are of the opinion that the jointed PVC pipe deformed differently from unjointed pipe even though the densification of the backfill material progressed as well. Fatigue testing of the joint resulted in higher vertical displacements.

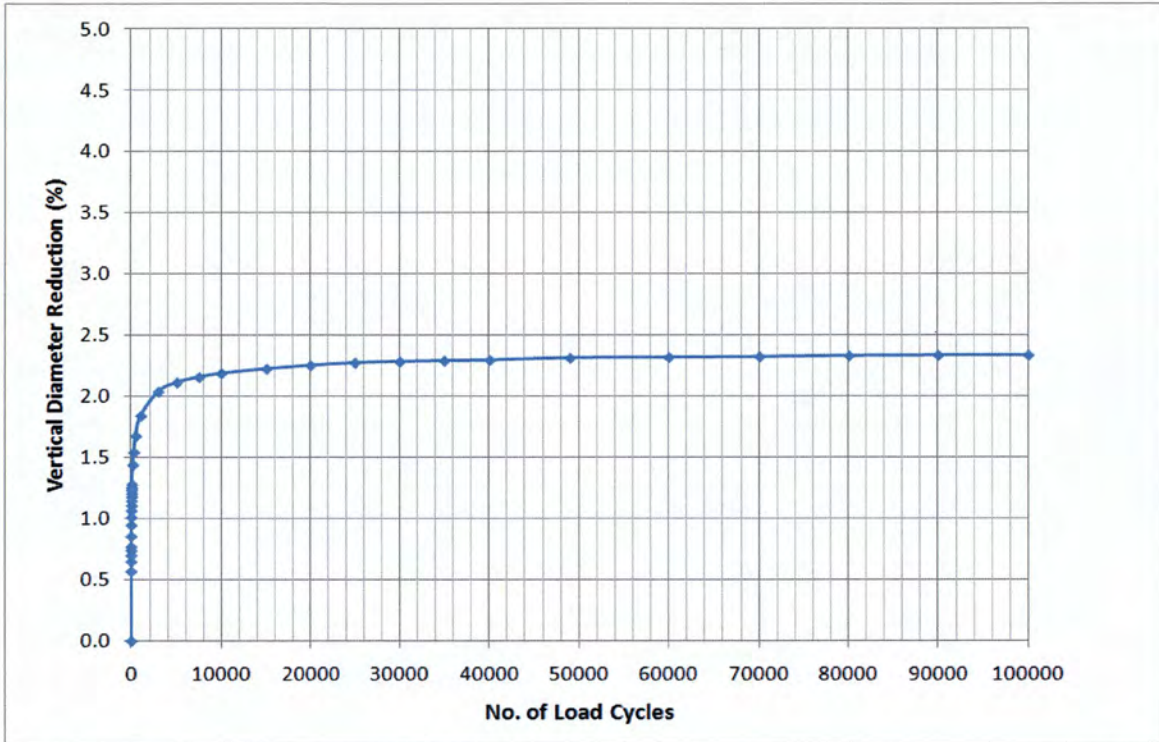

Figure 51. Percentage of Vertical Pipe Diameter Reduction of Jointed PVC Pipe.



Figure 52. Visual Inspection of Jointed PVC Pipe after Fatigue Test.

A parallel plate test was carried out on the jointed PVC pipe after the fatigue load test. Due to the presence of the joint, researchers stacked four strips of PVC pipe to provide a level load area, as illustrated in Figure 53.

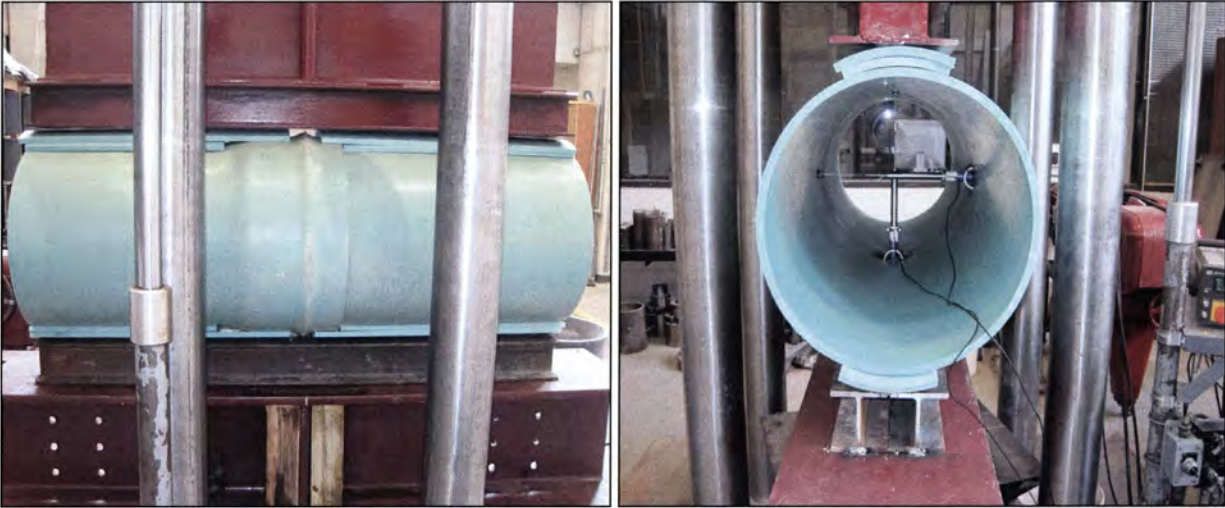

Figure 53. Parallel Plate Loading Test Setup of Jointed PVC Pipe.

The results of the testing indicated that the pipe stiffness did not vary between tested and untested pipes. The measured pipe stiffness was 87 psi in both cases. Researchers are of the opinion that the strips of PVC pipe used to make a level testing surface influenced the test measurements such that a higher pipe stiffness was determined from the parallel plate load test compared to that obtained from the unjointed PVC pipe. Note that for this test, the joint movement is relatively restrained, and the pipe bending would be less due to the presence of the PVC pipe strips.

Jointed Concrete Pipe

Given the fact that the jointed PVC pipe yielded more vertical displacement than the unjointed PVC pipe, researchers decided to conduct the concrete pipe test on a jointed pipe. Researchers prepared the pipe specimen as illustrated in Figure 54.



Figure 54. Concrete Pipe Testing Setup.

As expected, the vertical displacement of jointed concrete pipe subjected to static loading was much lower than PVC pipes tested as shown in Figure 55. The figure also shows a significantly higher opening of the joint as compared to the vertical displacement.

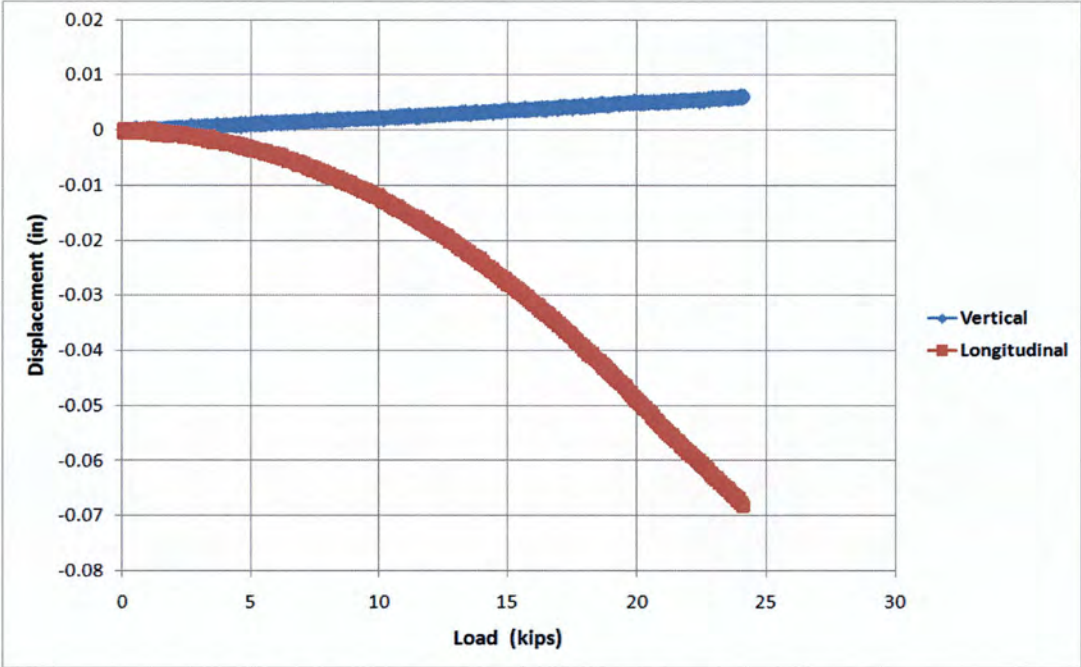

Figure 55. Static Test Result of Jointed Concrete Pipe.

Figure 56 shows the results of the fatigue loading test. It is observed that the measured vertical displacements are much smaller than those measured from the jointed and unjointed PVC fatigue tests and are considered to be negligible from a practical point of view. The vertical displacement was very small, around 0.01 in. at the end of the fatigue test or 0.05 percent in terms of pipe vertical diameter reduction.

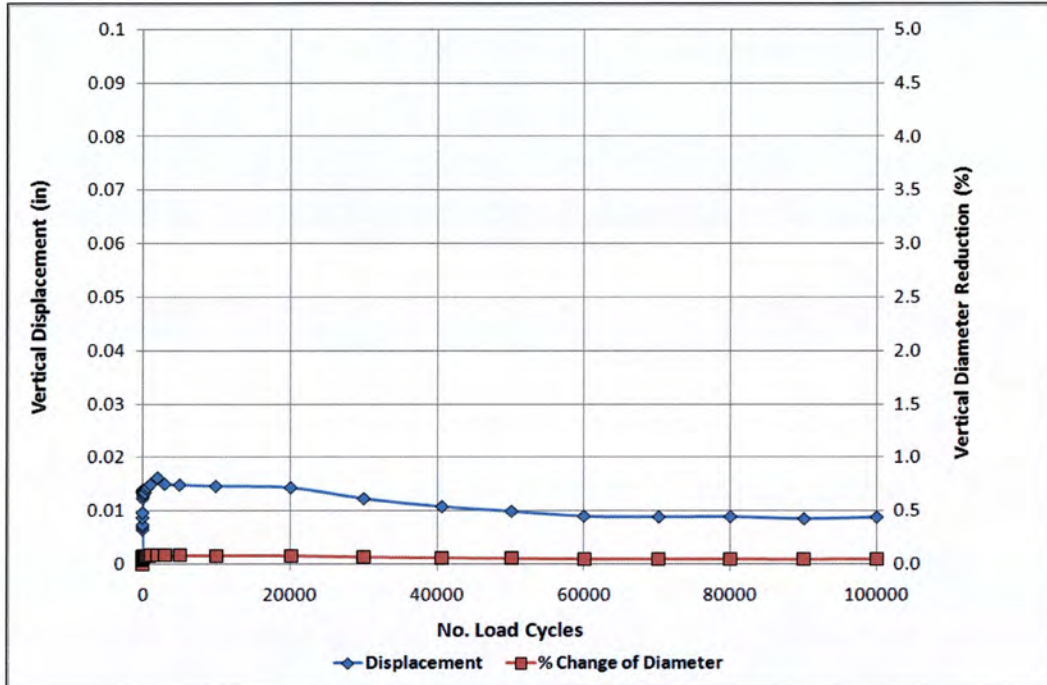

Figure 56. Fatigue Test Results of Jointed Concrete Pipe.

After fatigue testing, researchers conducted a visual inspection of the pipe and found crack damage close to the jointed area on the top side of the pipe as shown in Figure 57. Researchers suspect that the crack might have initiated after the pipe came into contact with the wall openings of the soil box due to gradual differential settlement of soil and gravel. No backfill material was observed leaking into the pipe during the fatigue test indicating that the crack remained closed during the test. The picture of the crack shown in Figure 57 was taken after the pipe was removed from the soil box. It is likely that the crack damage progressed further during that removal.



Figure 57. Concrete Pipe Fatigue Damage Observed.

Figure 58 shows the change of longitudinal displacement during the fatigue load test. Note that a much higher displacement occurred compared to the static load test shown in Figure 55 that seems to indicate the crack damage initiated at the early stage of the load cycles.

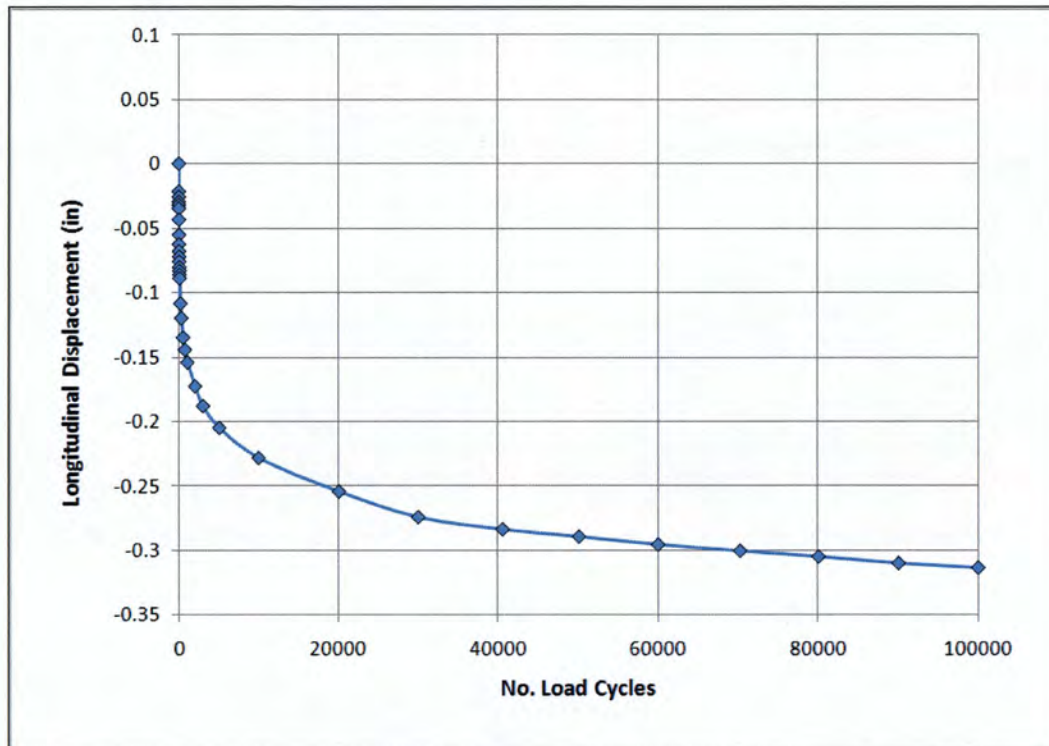

Figure 58. Longitudinal Displacement of Jointed Concrete Pipe from Fatigue Load Test.

Researchers conducted a parallel plate test on the jointed concrete pipe after the fatigue load test. Researchers installed clamping assemblies consisting of four all-thread rods and a total of four end plates to prevent joint separation during the test as illustrated in Figure 59. Note that only untested concrete pipe was used since the tested concrete pipe was damaged after the fatigue test.



Figure 59. Parallel Plate Loading Test Setup of Jointed Concrete Pipe.

Figure 60 shows that the vertical and horizontal displacements were approximately 0.15 in. at the end of the parallel plate load test. Researchers computed two sets of pipe stiffness, representing the crack initiation and crack propagation portions denoted in Figure 60. The test was halted due to progressive cracking, as illustrated in Figure 61, which resulted in a decrease of the applied load.

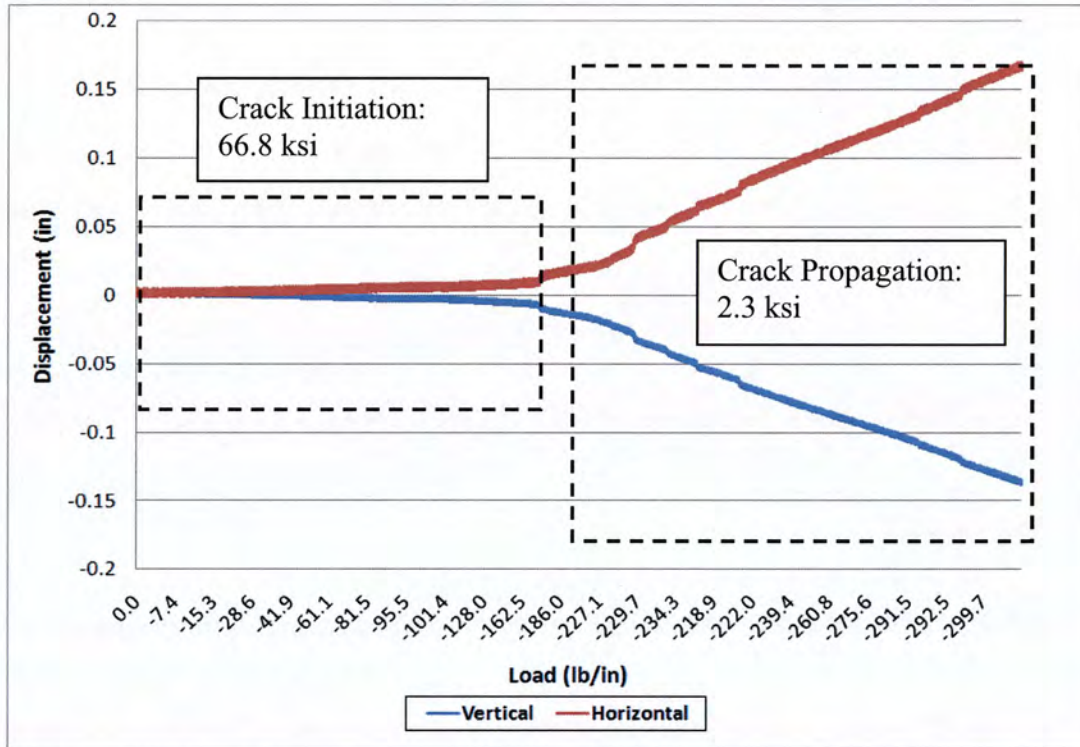

Figure 60. Load-Displacement Curves of Jointed Concrete Pipe from Parallel Plate Test.



Figure 61. Propagation of Crack of the Jointed Concrete Pipe.

In summary, the researchers note the following findings from the laboratory tests of buried pipes in the soil box:

- Jointed and unjointed PVC pipes deformed well within the 5 percent criteria for both static and fatigue soil box tests.
- Jointed pipe deformation was much higher than unjointed pipe due to joint opening behavior.
- The parallel plate loading tests of unjointed PVC pipes showed a reduction of pipe stiffness of 11 percent following the fatigue loading test.
- The vertical deformation of concrete pipe during the fatigue loading test was significantly lower than PVC pipes.
- The crack damage of the concrete pipe following the fatigue loading test was possibly due to differential settlement of the bedding layer and subsequent support of the pipe by the soil box wall openings resulting in more bending around the pipe mid-section.
- A parallel plate loading test on a new concrete pipe exhibited cracks progressing despite low level of vertical displacement along with a significant pipe stiffness reduction as the cracks progressed.

FINITE ELEMENT ANALYSES

Overview

To identify critical parameters that affect buried utility structures, the research team conducted a sensitivity analysis during the Phase I study. The objective of this task was (a) to determine characteristics of potential damage, (b) to compare results with field data as available, (c) to develop a risk matrix, and (d) to use results as guidance for the Phase 2 damage evaluation. Researchers evaluated the amount of damage to the buried pipe using a damage ratio. The damage ratio in this analysis was defined as the ratio of percent pipe vertical deflection to the 5 percent deflection criterion that is typically adopted in design practice. A damage ratio over 1 indicated the pipe deformed vertically above the 5 percent tolerance. Researchers used the PLAXIS 2D finite element program to conduct a sensitivity analysis and found the following:

- **Analysis Reliability and Calibration.** The predicted displacements using the PLAXIS 2D finite element program showed reasonable agreement with field test values taken from two previous studies.
- **Axle Positions.** Axles positioned symmetrically about the pipe produced maximum damage ratio based on predicted vertical displacements.

- **Axle Loads.** Higher axle load along with a larger number of axles resulted in a higher damage ratio.
- **Depth of Cover.** Depth of cover showed the most significant influence to predicted damage ratio.
- **Pipe Material.** The pipe material and wall thickness also influenced the damage ratio but its effect was relatively small compared to the effects of depth of cover, number of axles, and axle load magnitude.
- **Backfill Compaction.** Low compaction level of backfill material exhibited a higher damage ratio.

3D finite element programs have recently been utilized in several research projects to simulate highway and airport pavement response to truck and aircraft traffic loads. A parametric study was conducted by Fernando and Carter (211). This team employed Fourier transforms to model 3D behavior under the patch loading and used 2D finite element analysis to approximate the field quantities. They found that the relative thickness of the pipe had a significant influence on the magnitude of force and moment that the pipe will carry. The ratio of the pipe to soil moduli also influenced the magnitude of force and moment of the pipe, but the degree of significance was not as important as the relative thickness. The induced forces and moments due to surface loading reduced with increasing soil cover.

Kim et al. conducted a nonlinear 3D finite element analysis to investigate flexible pavement response due to multiple wheel loading (212). The full 3D nonlinear analysis indicated that errors due to single wheel load superposition may not be negligible. They also observed that pavement responses in a low volume flexible pavement structure were significantly influenced by multiple wheel loads.

Arockiasamy et al. conducted full-scale field tests on flexible pipes under live load application (199). They measured pipe deflection at various conditions of burial depth, soil compaction, and loading configuration. For the comparison of measured values, they predicted pipe deflection using the modified IOWA formula, CANDE 2D, and ANSYS 3D finite element programs. While the predicted value based on the 3D ANSYS program compared reasonably with the measured value, the other methods had a tendency to overestimate to a considerable degree.

In general, 3D finite element programs offer the most versatility in realistically modeling complicated load configurations. However, use of these programs requires advanced skills in generating the 3D finite element mesh and applying the appropriate boundary conditions. 3D finite element programs also require significantly longer computer running times and more powerful computers compared to 2D analysis, which is one reason why 2D applications are more widely used. However, with the given capability of 3D finite element analysis for modeling complicated load configurations, researchers conducted a numerical analysis using the 3D ABAQUS finite element program to verify the loading conversion method used for sensitivity analysis, and to more realistically model multiple tire and axle configurations of superheavy transport trailers.

3D FEM Modeling of Multiple Wheel Loads

The researchers modeled pipe-soil interaction due to multiple wheel loads using a 3D FEM modeling technique. The finite-element package ABAQUS 6.8 was used to perform the analyses.

Comparison of 2D versus 3D Analysis

NCHRP report 647 used the following procedure to consider 3D behavior that distributes live load along the length of the flexible pipe by modifying the load applied to the surface of the 2D finite element mesh (213):

Step 1. Determine the wheel interaction depth:

$$H_{int} = \frac{s_w - \frac{w_t}{12} - \frac{0.06D_i}{12}}{LLDF_i} \quad (24)$$

where

- H_{int} = the wheel interaction depth (ft).
- s_w = the wheel spacing (6 ft).
- w_t = the tire patch width (20 in.).
- $LLDF_i$ = the live load distribution factor (1.15).
- D_i is the inside diameter of the pipe (in.).

Step 2. Determine the live load area and pressure:

$$\text{For } H < H_{int}, A_{LL} = \left(\frac{w_t}{12} + LLDF_i \times H + 0.06 \times \frac{D_i}{12} \right) \times \left(\frac{l_t}{12} + LLDF_i \times H \right) \quad (25)$$

$$W_{LL} = LL / A_{LL} \quad (26)$$

$$\text{For } H \geq H_{int}, A_{LL} = \left(\frac{w_t}{12} + s_w + LLDF_i \times H + 0.06 \times \frac{D_i}{12} \right) \times \left(\frac{l_t}{12} + LLDF_i \times H \right) \quad (27)$$

$$W_{LL} = 2 \times LL / A_{LL} \quad (28)$$

where

- A_{LL} = the live load area.
- W_{LL} = the live load pressure (psf).
- H = the pipe depth (ft).
- l_t = the tire patch length (20 in.).

Step 3. Determine the governing load length:

$$\text{For } H < 0.833, L_{t, gov} = l_t / 12 \quad (29)$$

$$\text{For } H \geq 0.833, L_{t, gov} = l_t / 12 + LLDF_l \times H \quad (30)$$

where

$L_{t, gov}$ = the governing load length (ft).

Step 4. Determine the service live load:

$$W_L = MPF \times (1 + IM) \times W_{LL} \times \min(D_i / 12, L_{t, gov}) \quad (31)$$

where

MPF = the multiple presence factor (1.2).

For the purpose of this research, the team generated two meshes (2D and 3D) using PLAXIS and ABAQUS program, respectively, as shown in Figure 62. The pavement structure in this analysis consisted of a 6 in. flexible base over 36 in. of backfill material over a sand subgrade, which is an unpaved condition that results in more conservative estimates of pipe deflection. As a matter of fact, during the construction phase, a buried structure may actually experience surface loading from vehicular traffic prior to the completion of a pavement layer.

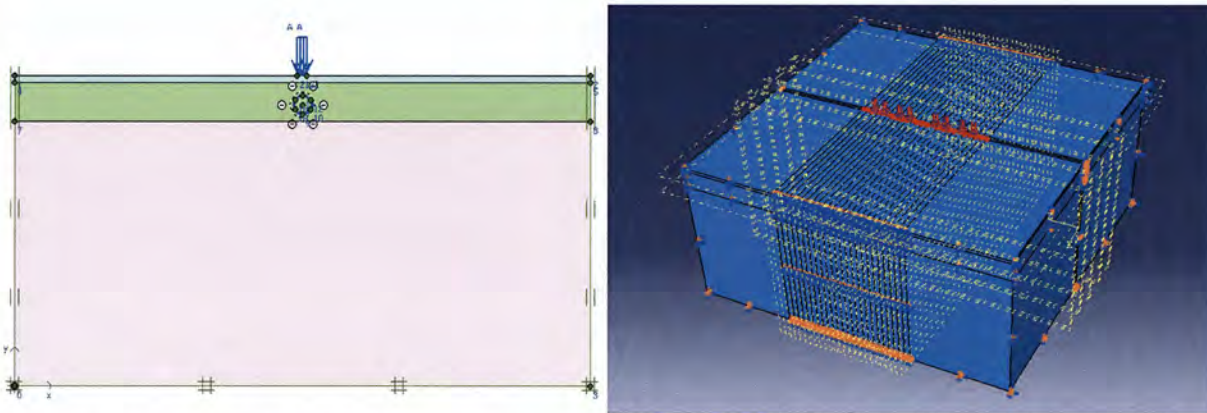

Figure 62. Finite-Element Meshes Used in Analysis (Cross Sectional View and 3D View.)

The research team employed the Mohr-Coulomb model to simulate soil behavior realistically. Table 57 presents material properties used in the analysis based on values reported in the literature (199, 213). A wheel load of 24,000 lb representing an HS-30 truck was considered. Using equation (31), a 2D load was computed, and a distributed load along the pipe was applied through 3D analysis. The length of distributed load used in the 3D analysis was 24 ft and covers a two lane width of the pavement.

Table 57. Parameters for Mohr Coulomb Model.

| Soil Type | Modulus of Elasticity (psi) | Poisson's Ratio | Angle of Friction (deg) | Dilatation Angle (deg) | Cohesion (psi) |
|-----------|-----------------------------|-----------------|-------------------------|------------------------|----------------|
| Base | 40000 | 0.35 | 57.0 | 27.0 | 6.0 |
| Backfill | 4100 | 0.29 | 54.3 | 24.3 | 0.001 |
| Sand | 5000 | 0.21 | 38.0 | 8.0 | 2.0 |

With respect to the depth of cover of pipe, researchers positioned an 18-in. PVC pipe at 18 in. from the top of the base layer. The wall thickness of the pipe was 0.5 in. using an elastic modulus of 100 ksi. The analysis result indicated that the maximum vertical deflections of pipe calculated from the two models were very close. The 3D analysis produced 0.228 in., and the 2D model based on the converted load using equation (24) yielded 0.218 in.

Researchers extended this analysis to investigate the effects of a larger number of axles using 2D and 3D analyses. Figure 63 shows the position of five axles considered in this analysis. As noted, the 3D mesh is capable of imposing individual tire loads along the axle. The axles were distributed with respect to the pipe symmetrically since it was found that the maximum displacement of pipe was obtained under this position based on sensitivity analysis conducted in this study and a field monitoring conducted by Sezen et al. (214).

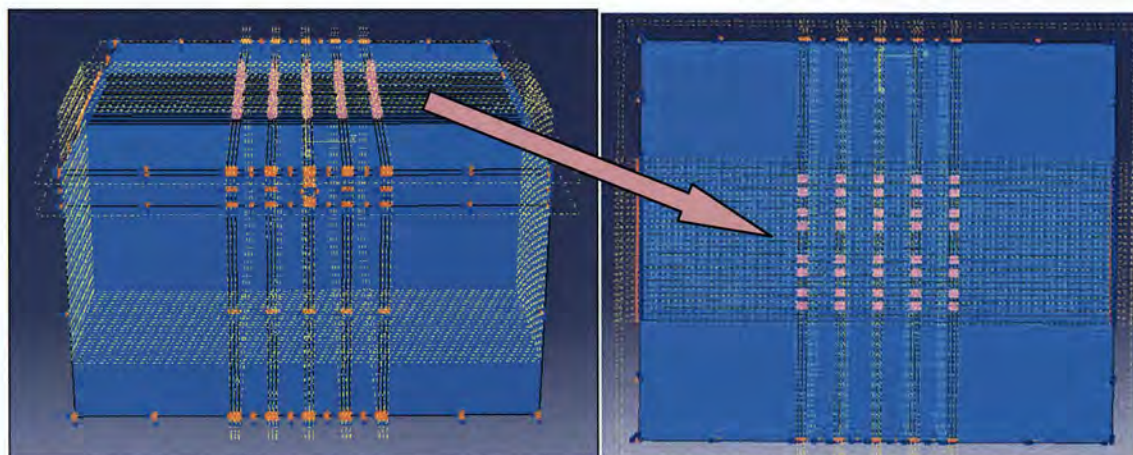

Figure 63. Illustration of 3D Mesh Used for Five Axles (3D View and Bird's Eye View).

The analysis results indicated the two methods based on 2D and 3D FEM modeling predicted almost identical maximum vertical displacements as presented in Table 58. Researchers are of the opinion that the results of the Phase 1 sensitivity analysis employing the loading conversion methods from the NCHRP 15-29 study, seem to be valid based on the comparisons made between the results obtained from the 2D and 3D analyses.

Table 58. Comparison of Vertical Displacements of Pipe.

| Number of Axles | 2D | | 3D | |
|-----------------|----------------------------------|----------------------|----------------------------------|---------|
| | Max. Vertical Displacement (in.) | VDR (%) ^a | Max. Vertical Displacement (in.) | VDR (%) |
| 3 | 0.267 | 1.5 | 0.2703 | 1.5 |
| 5 | 0.315 | 1.8 | 0.3108 | 1.7 |

^a Vertical Diameter Reduction.

Modeling of Multiple Tires and Axles

Given the positive verification of 2D analysis results using 3D analysis, researchers made an attempt to model an actual superheavy load move that occurred in 2002. The total weight of the move was 1,999,980 lb, composed of 19 axles with 4-ft axle spacing and 8 tires per axle. Each axle load was 100,000 lb, resulting in 12,500 lb per tire. Researchers modified the 2D mesh used for the previous analysis to accommodate 19 axles to investigate the effects of multiple axles on the buried pipe by varying the number of axles as shown in Figure 64. The length of the mesh was extended to 150 ft.

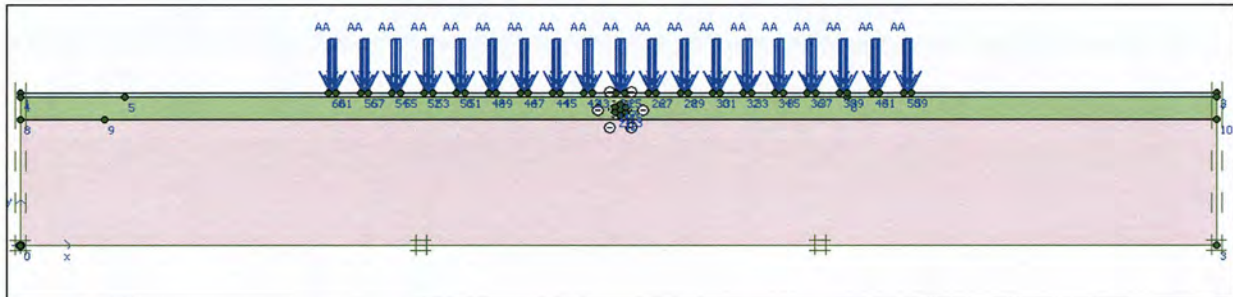

Figure 64. 2D Mesh for a Superheavy Load of 19 Axles.

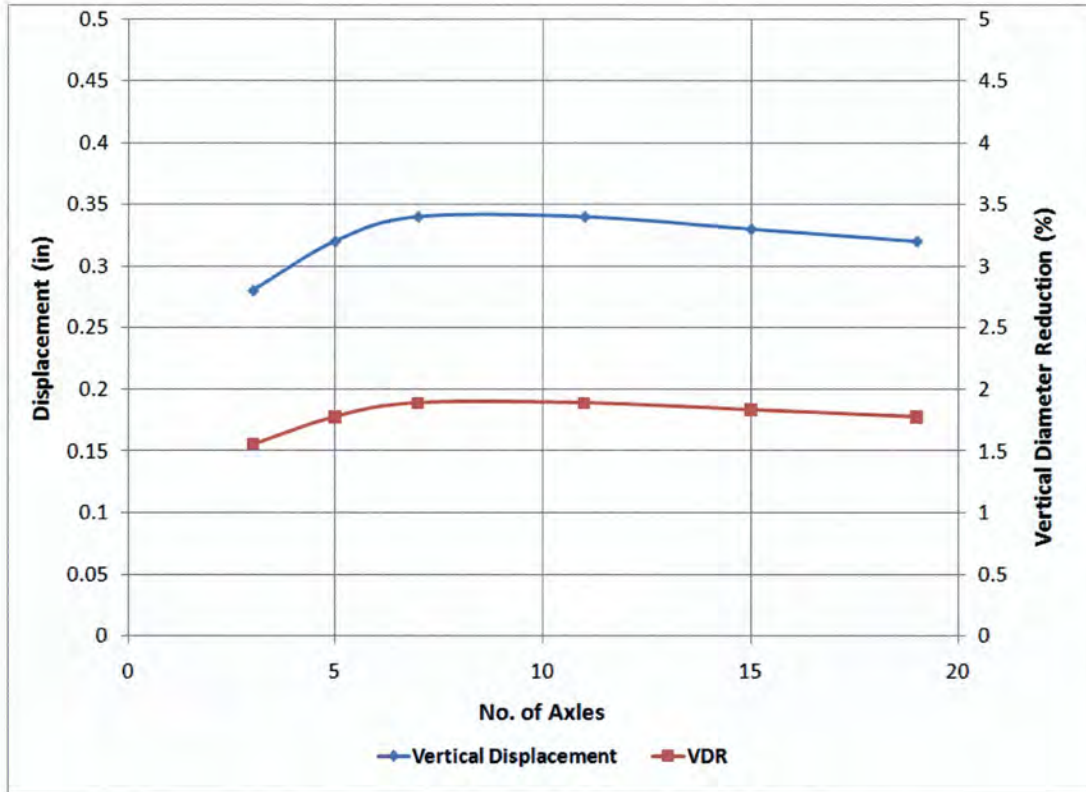

Figure 65. Effect of Multiple Axles on Pipe Deformation.

Figure 65 shows the variation of vertical displacement and the percentage change of the pipe vertical diameter versus the number of axles considered. This figure indicates that the vertical displacement and vertical diameter reduction tend to increase as the number of axles increases. However, after seven axles the predicted pipe deformation gradually decreases as more axles are modeled in the analysis. The decrease of vertical displacement is attributed to the confinement of the soil layer since the distribution of traffic loads increased with larger number of axles.

Modeling of Aged Pipe

Researchers conducted an analysis to predict the vertical diameter reduction of aged pipe. In this regard, the power law formulation has been used to model elastic modulus of HDPE pipe as a function of time (205). The model was formulated based on the stress relaxation test in which load is measured over a period of time for a pipe deflected under constant strain (204). Hashash used his power law model to extrapolate the data to 50 years to evaluate the long-term field performance of HDPE pipes, as given below (205):

$$E(t) = 67779t^{-0.0859} \quad (32)$$

$E(t)$ is expressed in psi, and t is measured in hours. Using this equation, researchers calculated elastic modulus at different times to conduct a 3D finite element analysis with a given initial pipe modulus of 100 ksi. For this analysis, 11 axles were considered. As shown in Figure 66, there is

a gradual increase in the vertical pipe deflection over a period of 50 years. Most of the pipe deflection was achieved at an early stage of the service life of the pipe. However, considering the significant reduction in pipe elastic modulus, the increase of pipe vertical deflection of approximately 0.2 percent seems insignificant.

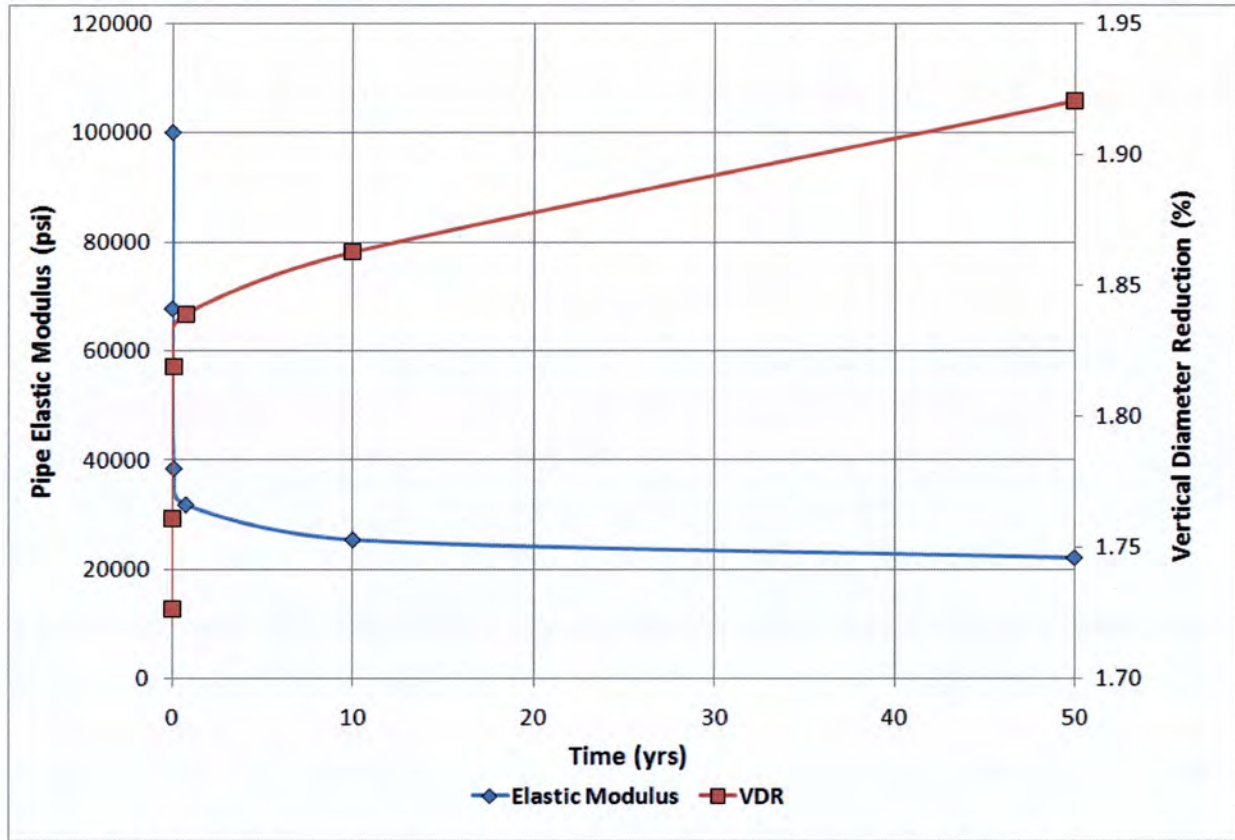

Figure 66. Predicted Vertical Pipe Diameter Reduction and Elastic Modulus over a 50-year Period.

Sensitivity Analysis of Phase II

Based on the results from experimental programs and additional finite element analysis conducted during Phase II, the research team decided to proceed with the sensitivity analysis using PLAXIS and ABAQUS as the analysis tools. Based on the results of the Phase I sensitivity analysis and laboratory tests conducted during Phase II, the researchers selected the following factors to be accounted for in the analysis.

- Depth of cover.
- Pipe material.
- Uniformity of bedding layer.

Table 59 and Table 60 show the analysis variables for this evaluation.

Table 59. Variables and Material Properties Used in Sensitivity Analysis.

| Variable | Description |
|-----------------------------|---|
| Depth of cover (ft) | 1, 1.5, 2, and 3 |
| Pipe material | PVC and concrete |
| Uniformity of bedding layer | Bedding layer with uniform modulus versus non-uniform modulus |
| Pavement type | Non-paved (6" base + backfill material + sand subgrade achieving 95% based on AASHTO standard compaction) |
| Axle weight (kips) | 48 |
| Number of axles | 7 |
| Pipe size | PVC: 18 in. inside diameter, 0.5 in. wall thickness Concrete: 20 in. inside diameter, 2 in. wall thickness |
| Pipe property | E = 400 ksi for PVC E = 2900 ksi for concrete |
| Base property | E = 35,000 psi, $\nu = 0.35$ Angle of friction (ϕ) = 56° Dilatation angle (φ) = 0° Cohesion (c) = 8 psi |
| Backfill property | E = 5000 psi, $\nu = 0.3$ Angle of friction (ϕ) = 48° Dilatation angle (φ) = 18° Cohesion (c) = 0.001 psi |

Table 60. Subgrade Properties Used in Sensitivity Analysis.

| Depth (ft) | E (psi) | ν | ϕ (deg) | φ (deg) | c (psi) |
|-------------------|----------------|-------------------------|--------------------------------|-----------------------------------|----------------|
| 0 to 1 | 1600 | 0.40 | 31 | 0 | 0.15 |
| 1 to 5 | 4100 | 0.30 | 31 | 0 | 0.15 |
| 5 to 10 | 6000 | 0.24 | 31 | 0 | 0.15 |
| 10 to 20 | 8600 | 0.23 | 31 | 0 | 0.15 |

Results of the Sensitivity Analysis

Depth of Cover and Pipe Material

Four levels of depth of cover were considered in this analysis (see Table 59). These levels covered the range of depths found from the review of existing specifications. Figure 67 shows the sensitivity of the damage ratio to the depth of cover. The result indicated the shallower the pipe, the higher the predicted vertical pipe deflection and damage ratio. Note that all analyses conducted are based on static loading condition. Similar to the findings of the laboratory static loading test, all damage ratios were found to be below 1 indicating that the predicted vertical deformation of the pipe is within the 5 percent tolerance. With respect to pipe material, the predicted damage ratio drastically decreased as the pipe material changed from PVC to concrete due to the higher material stiffness. This finding is in accord with the results from the laboratory tests conducted in this project.

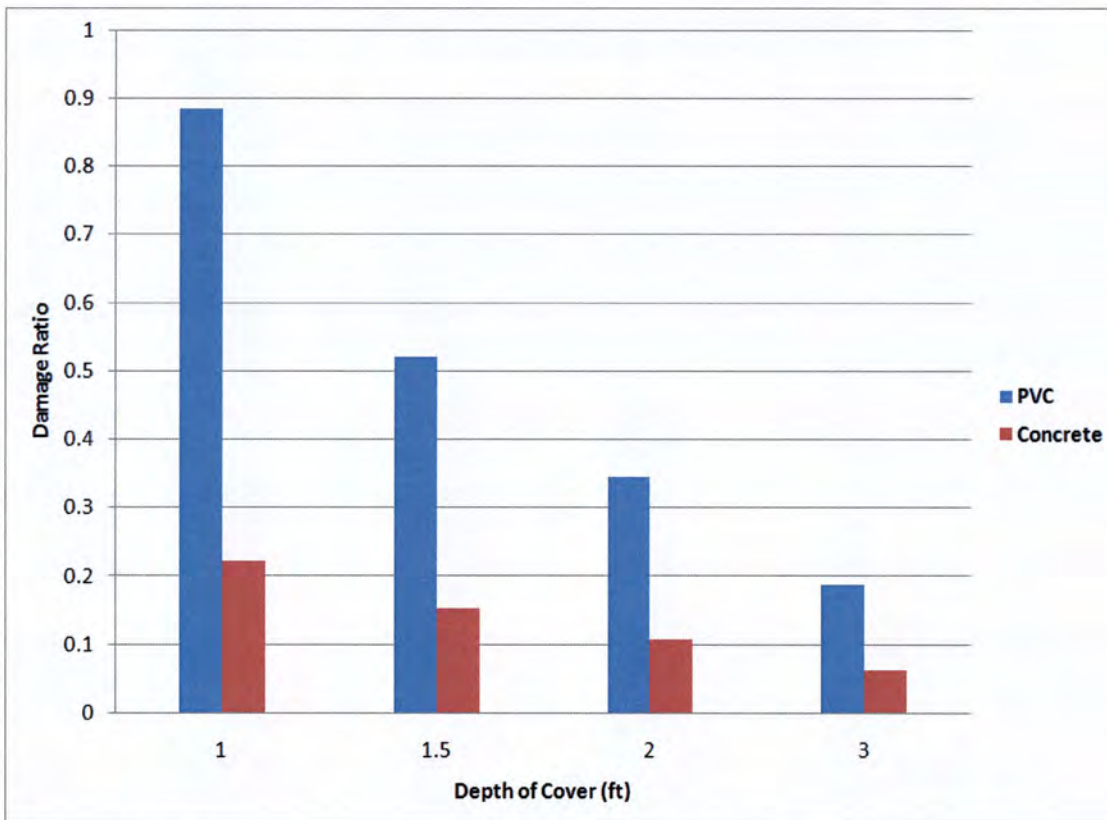

Figure 67. Sensitivity of Damage Ratio to the Depth of Cover for PVC and Concrete Pipes (Using PLAXIS Analysis Software).

Uniformity of Bedding Layer

Researchers considered three different levels of uniformity for the pipe bedding layer as follows.

- Case I: the bedding layer underneath the pipe has a uniform layer modulus (modulus of bedding 1 and 2 are equal).
- Case II: the bedding layer 2 has 75 percent of the bedding layer 1 layer modulus.
- Case III: the bedding layer 2 has 50 percent of the bedding layer 1 layer modulus.

For Cases II and III, researchers also considered two bedding layer orientations as illustrated in Figure 68 (a) and (b).

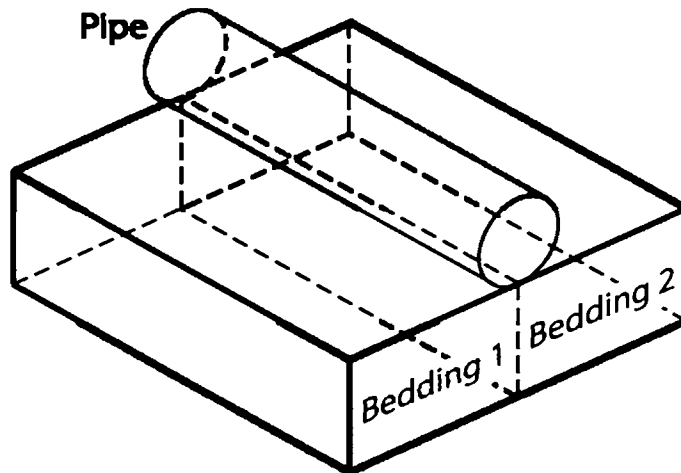

(a) Bedding layer non-uniformity longitudinal to pipe.

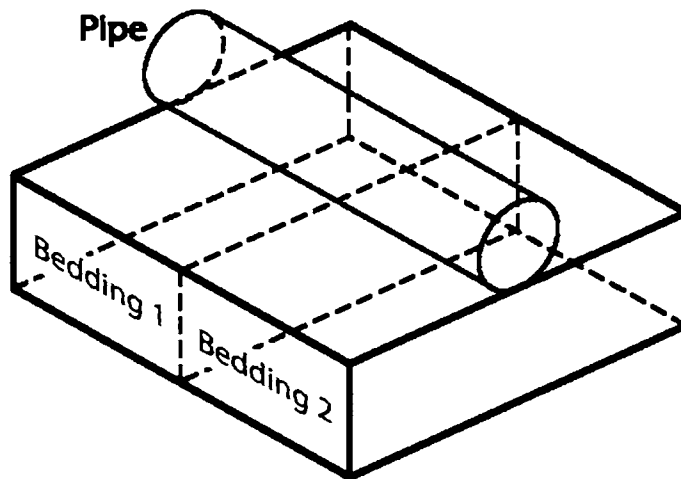

(b) Bedding layer non-uniformity at 90° angle.

Figure 68. Layout of Bedding Layer Composition.

For the comparisons, researchers assumed the concrete pipe was positioned at an 18-in. depth from the unpaved surface and subjected to seven HS-30 design axle loads. Figure 69 shows the effect of non-uniformity of the bedding layer on predicted vertical deflections. With non-uniform bedding, the predicted damage ratio slightly increased as one half of the bedding layer degraded or became softer. A non-uniform bedding layer at a 90° angle (condition (b) in Figure 68) leads to a slightly higher damage ratio. Researchers are of the opinion that this non-uniform bedding layer preparation might take place in practice. In cases where the pipe receives repeated fatigue loads under this condition, the increase of damage ratio might be aggravated. However, even with a non-uniform bedding layer, the research team was not able to produce a damage ratio larger than one, which could have explained the cracked jointed concrete pipe. As such, the researchers were able to conclude that a non-uniform bedding layer was most likely not the cause of the cracked jointed concrete pipe.

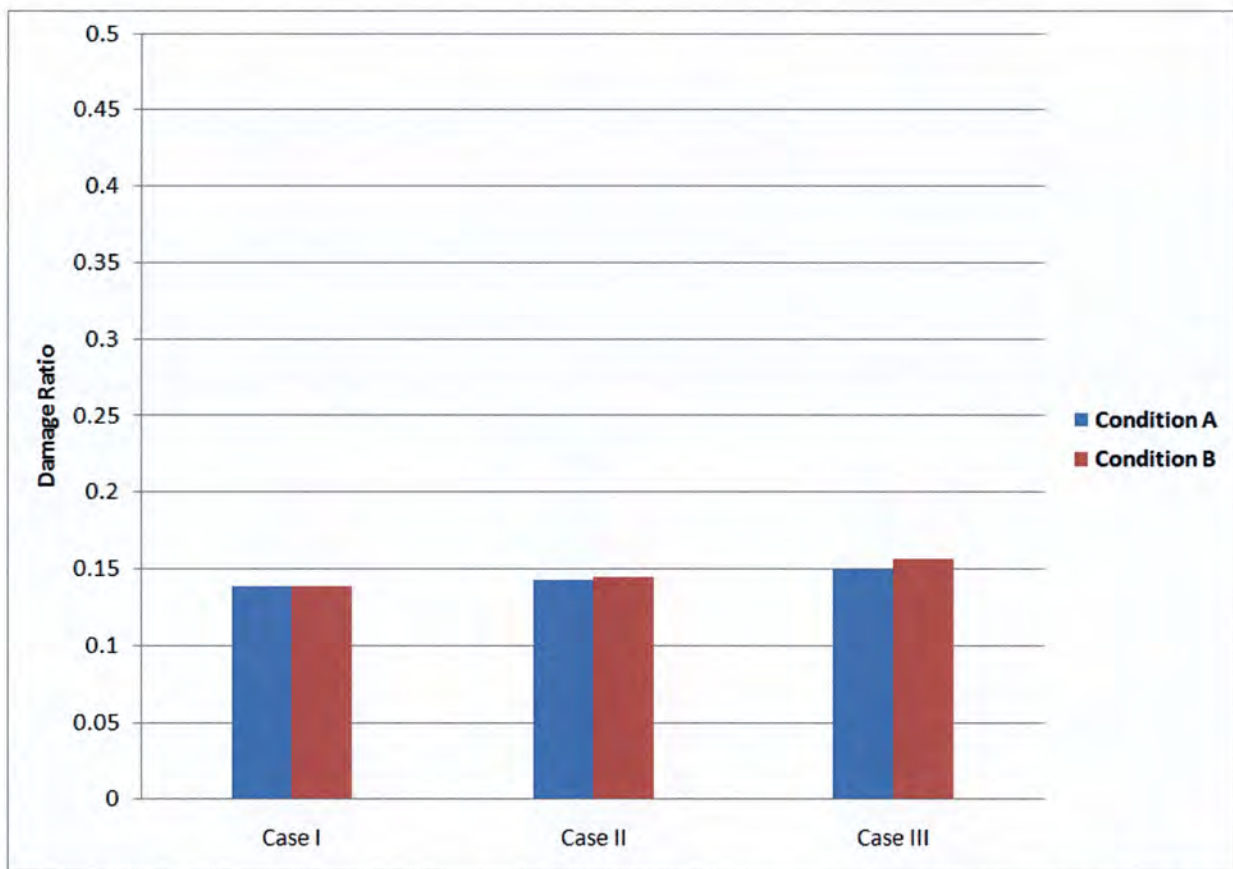

Figure 69. Sensitivity of Damage Ratio to the Uniformity of Bedding Layer (Using PLAXIS Analysis Software).

As a result, researchers conducted additional 3D analysis to verify the fatigue damage shown in Figure 57. As stated earlier, researchers hypothesized the pipe might have been supported by the wall opening of the soil box due to gradual differential settlement of the bedding layer along with the repeated loads. To simulate this, researchers schematically assumed two cases for simplicity as illustrated in Figure 70: (a) the pipe is fully supported by bedding layer, and (b) the pipe is only supported at both ends by the bedding layer.

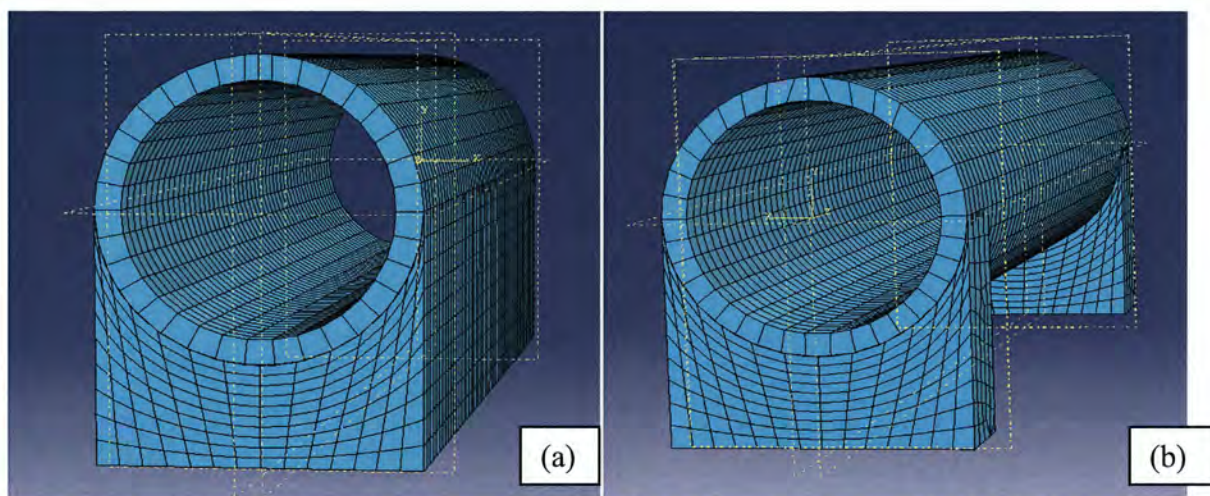

Figure 70. Pipe Bedding Conditions Considered: (a) Uniform Support, (b) Support at Ends Only.

The results indicated that the level of deformation and stress obtained from case (b) significantly increased compared to the results of case (a) as shown in Figure 71 to Figure 74. In Figure 71 and Figure 72, the variation of vertical displacement surrounding the pipe is indicated by a color scale. The legend shown in the top-left side indicates the red zones exhibit the smallest displacement while the maximum displacement corresponds to the blue zones. As the pipe is supported under condition (b), the pipe experienced almost 1.6 times greater vertical displacement along the top side of the pipe, as shown in Figure 72.

In Figure 73 and Figure 74, the variation of Von Mises stress surrounding the pipe is indicated by a color scale. The Von Mises stress is widely used as an indicator to predict yielding of materials. The legend shown in the top-left side of each figure indicates that the red zones exhibit maximum stress while the minimum stress corresponds to the blue zones. As the pipe is supported under condition (b), the pipe experienced almost 3.7 times greater Von Mises stress along the top middle portion of the pipe, as shown in Figure 74. The greater stress in this location appears to be consistent with the researchers' observation that the crack formed at the top of the joint during the fatigue test. Also note that condition (a), which represents full bedding support of the pipe, resulted in far lower stresses of a magnitude not high enough to cause a crack in the concrete pipe.

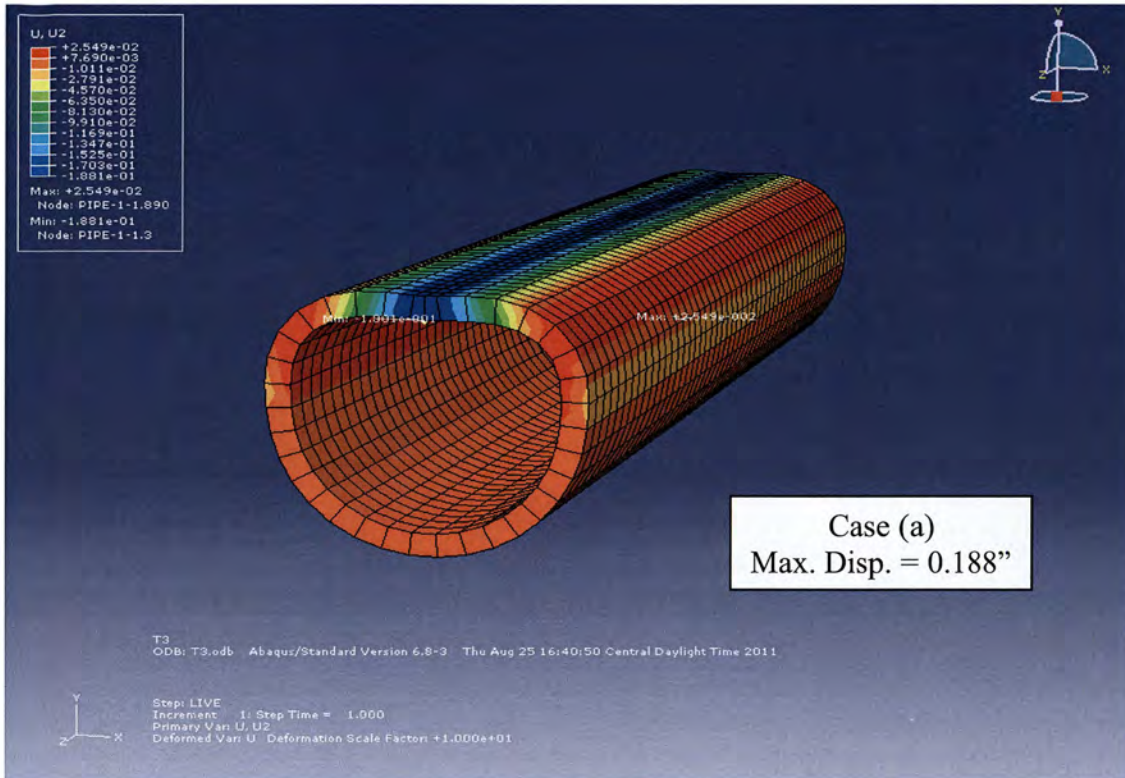

Figure 71. Calculated Vertical Displacement, Condition (a) (Blue Indicates Largest Displacement).

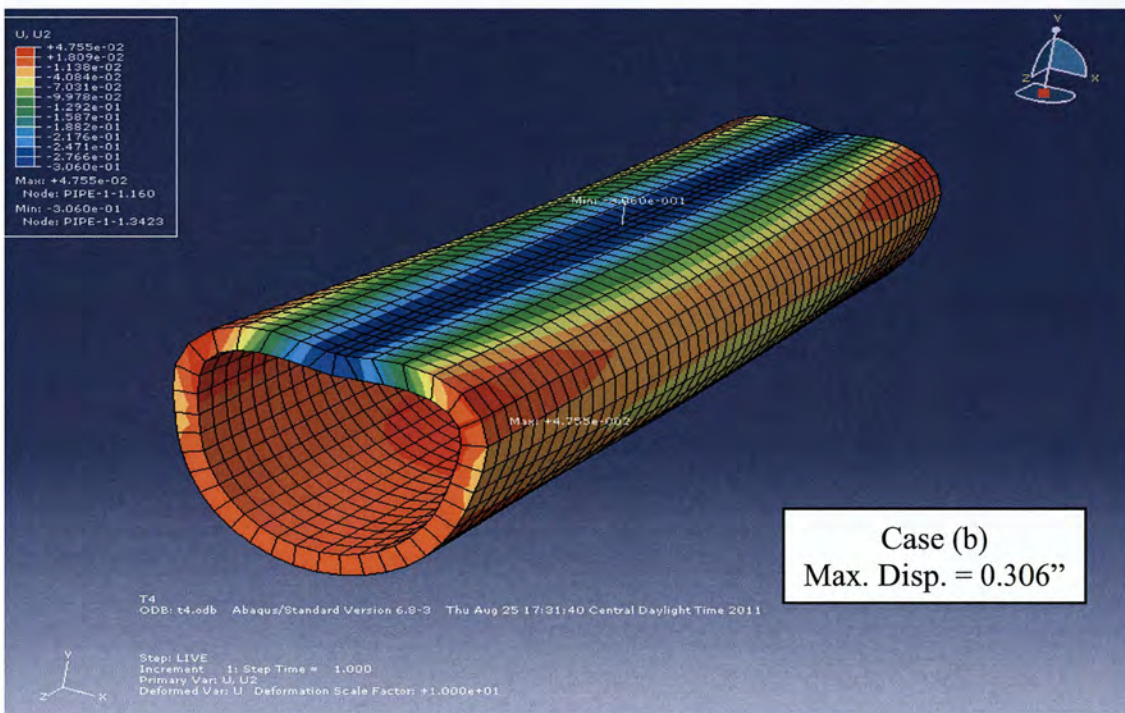

Figure 72. Calculated Vertical Displacement, Condition (b) (Blue Indicates Largest Displacement).

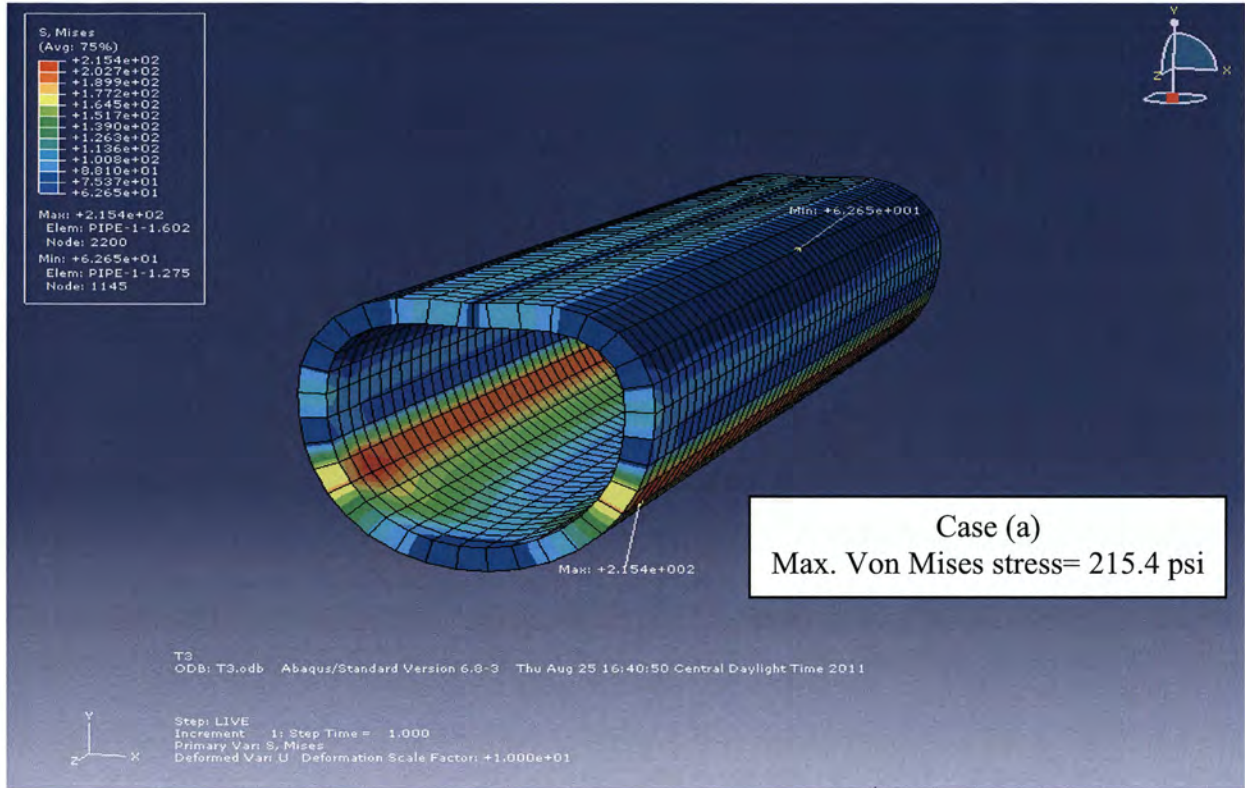

Figure 73. Calculated Von Mises Stress, Condition (a) (Red Indicates Highest Stress).

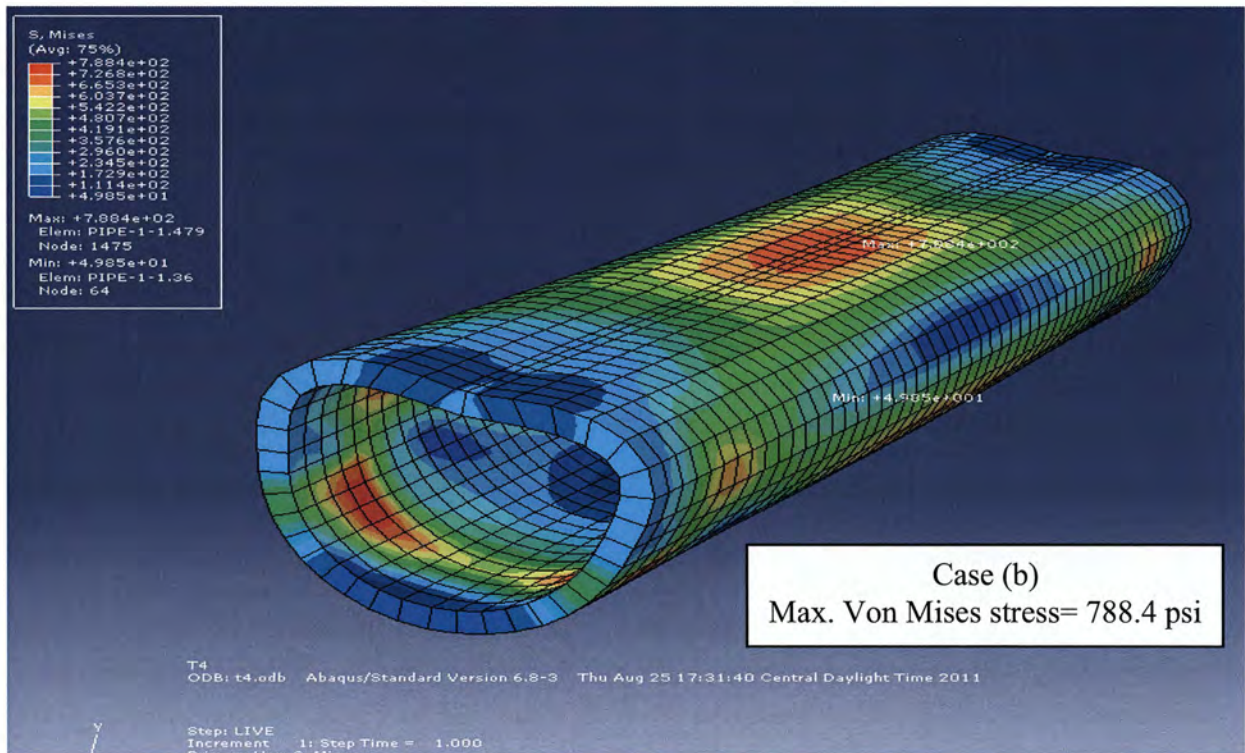

Figure 74. Calculated Von Mises Stress, Condition (b) (Red Indicates Highest Stress).

In summary, the researchers found the following from the finite element analysis of buried utility pipe:

- The method described in NCHRP 647 to consider the 3D load effect for 2D analysis seems valid based on the 3D analysis conducted in this project. In this regard, the results of the sensitivity analysis using 2D FEM modeling are also valid.
- A larger number of axles and tires were successfully modeled using the 3D finite element method.
- A number of axles larger than seven produced less vertical displacement and vertical diameter reduction due to soil confinement along with enhanced load distribution.
- The aged pipe modeling using Hashash's model to incorporate a reduction of pipe modulus yielded an insignificant effect on pipe deformation in the long term.
- Additional sensitivity analysis on depth of cover and non-uniformity of bedding layer was conducted taking into account the conditions that were used in the Phase II study. The results were consistent with the findings from laboratory testing.
- Using 3D modeling, an attempt was made to simulate pipe behavior supported under different conditions. The results indicated that the pipe not fully supported yielded more displacement and Von Mises stress sufficient to generate a crack, as observed in the fatigue load test of the concrete pipe.

CHAPTER 7. CONCLUSIONS AND RECOMMENDATIONS

OVERVIEW

This chapter provides a summary of the findings, conclusions, and recommendations of the research team based on the outcome of the sensitivity analysis, FEM analysis, laboratory testing, meetings with stakeholders, and document review. These findings are organized in the following five sections:

- Summary of Technical Design and Engineering Requirements for Utility Accommodation.
- Assessment of Potential Impact of Overweight Loads on Buried Utilities.
- Recommendations for a Business Process for Overweight Routing Coordination.
- Recommendations for Changes to TxDOT Manuals.
- Recommendations for Changes to the Utility Accommodation Rules.

SUMMARY OF TECHNICAL DESIGN AND ENGINEERING REQUIREMENTS FOR UTILITY ACCOMMODATION

In general, piping materials are classified as flexible or rigid. A flexible pipe is deemed to produce at least 2 percent deflection without regard to structural distress. Materials that do not meet this criterion are generally considered rigid. Rigid pipes are mainly classified into three types based on material type used: asbestos-cement pipe, clay pipe, and concrete pipe. For rigid pipes, strength to resist wall stress due to the internal pressure and external loads is critical in design. Ductile iron (cast iron), steel, and thermoplastic pipes are usually considered flexible. For flexible pipes, stiffness is a critical factor in resisting ring deflection and buckling. The research team found the following with regard to technical and engineering requirements for utility installations:

- Concrete pipes are often required to be designed and manufactured in accordance with AWWA M 9, AWWA C301-72, AWWA C303-78, and AWWA C303 (8, 20, 19, 38). Reinforced concrete pipe was dominant prior to manufacturing of prestressed concrete pipe. The difference in construction of this pipe from prestressed concrete is that mild steel reinforcement is cast into the wall of the pipe instead of prestressing with high strength wire.
- Asbestos-cement pipes are applicable for both gravity and pressure systems. Asbestos-cement pipe for water systems often conform to ASTM C296 or AWWA C400 (21, 22). However, production of this pipe has been halted in the U.S. because of hazardous risks associated with the material.

- Vitriified clay pipe is manufactured from clay and shale, which are chemically inert. This type of pipe is very corrosion and abrasion resistant but only used for non-pressure applications due to its inherent low strength (2000 to 7000 psi.) Available pipe size ranges from 3 to 42 in. in nominal diameter. Vitriified clay pipes are often used for sewer lines larger than 15 in. in diameter and often use manufacturing standard ASTM C700 (28).
- Ductile iron pipe is very popular and often the preferred material in public works with respect to repair and maintenance of waste water systems. Water distribution line installations are often designed to withstand a working pressure of 150 psi. Typical standards require ductile iron pipes meeting the requirement of AWWA C151/ANSI A21.51 (16). Other popular standards are AWWA C110, AWWA C111, and AWWA C150 (35, 36, 17). Ductile iron pipe usually is coated with a cement-mortar lining to improve the hydraulic efficiency and provide some corrosion protection.
- Steel pipes are less frequently used for water installations. If used for water lines, popular standards for steel pipes are AWWA Manual M 11 and AWWA C200 (2, 3). Steel pipe is more frequently used as casing pipe. Steel casing pipe typically conforms to ASME B36.10 and other local special provisions (39).
- Thermoplastic pipes are also widely used in various water systems. There are four principal materials used: polyvinyl chloride (PVC), acrylonitrile-butadiene-styrene (ABS), polyethylene (PE), and polybutylene (PB). Most plastic pressure or sewer pipes are made of PVC. PVC pipe for water lines is often Class 150 conforming to AWWA C900 (23). Pipe for sewer lines is typically larger than 6 in. in diameter and mostly PVC if less than 15 in. in diameter, meeting the requirements of ASTM D 3034 (25). The main advantage of PVC pipe is its high strength-to-weight ratio and resistance to almost all types of corrosion from chemical and electrochemical processes. Thus, any type of lining or coating is not required. However, the performance of PVC pipe is significantly affected by its operating temperature.
- Fiberglass pipe, another material used for flexible pipe systems, is made from glass fiber reinforcements embedded in or surrounded by cured thermosetting resin. Since the 1960s, fiberglass pipe has been used for municipal water and sewage applications due to temperature, chemical, abrasion, and weathering resistance.

In general, piping systems should be designed to perform from 50 to 100 years since both government and private sectors cannot generally afford to replace pipe systems at less than 50-year intervals. The service life is not just a function of pipe material itself, but is mainly tied to the loading or environmental conditions to which the pipe system is subjected.

ASSESSMENT OF POTENTIAL IMPACT OF OVERWEIGHT LOADS ON BURIED UTILITIES

The goal of this assessment was to develop a thorough understanding and documentation of the potential impact of overweight loads on buried utilities to support the development of recommendations with respect to utility accommodation that would minimize this impact. The direction and scope of Phase 2 largely depended on the findings from Phase 1, particularly with respect to findings from a review of the historical evolution of UARs and design standards for buried utilities within the right of way.

The research team attempted to identify case studies involving damage to buried utilities due to overweight loads, which involved an extensive outreach effort conducted in Phase 1 of the research. This outreach effort included the following:

- A letter from the Right of Way Division to utility stakeholders requesting information about utility lines that were damaged or were suspected to be damaged due to overweight load transports in Texas, disseminated to over 400 utility stakeholders.
- A general review of trade magazines, newspapers, and journals focusing on utilities damaged by overweight transports.
- A review of emergency work authorizations of the Utility Installation Review system and numerous follow-up phone calls to utility representatives.
- Contacting several TxDOT district maintenance directors and maintenance supervisors.
- Contacting water/sewer departments of several major cities including:
 - City of Beaumont Water Utilities Department.
 - City of Port Arthur Water Utilities Department.
 - City of Corpus Christi Water Department.
 - City of Kingsville Water Department.
 - City of Houston Department of Public Works and Engineering.
 - Texas City Utilities Department.
 - City of Big Spring Utility Maintenance Department.
 - Trinity River Authority (Northern Region).

This outreach effort did not identify any incidents of damage to buried utilities within the right of way due to overweight loads. Thus, in lieu of case studies, researchers conducted a sensitivity analysis to evaluate the effects of various risk parameters on the potential damage to buried utilities

due to overweight loads. This sensitivity analysis used existing design criteria obtained from a review of current specifications as described in Chapter 5.

The general finding from this Phase 1 analysis suggested that current design standards appeared to be adequate. However, in light of the fact that piping systems are typically designed to perform about 50 to 100 years, some piping systems in place today may have been installed before rules for underground utilities were codified in the Texas Administrative Code in 1979, and thus may have been installed using a lower standard. Yet the lack of evidence for damage to buried utilities caused by overweight loads implies that both past and current design standards have been adequate thus far.

The question remaining after the Phase 1 analysis was if the recent increase in repetitive overweight load traffic might negatively impact buried utilities. A worst case scenario could be a utility installed decades ago using a lower installation standard than currently required, located on a low volume road that becomes a highly frequented overweight traffic route. Estimating the impact of such repetitive loads on buried utilities was conducted during the Phase 2 utility damage evaluation in the second year of this project. Based on laboratory static load test and sensitivity analysis, the researchers estimate that a depth of cover of 18 in. could be sufficient if the pipe was perfectly installed, and no bedding settlement occurred over time. However, this case is not representative of actual field conditions where settlements and uneven load distribution cannot be entirely excluded. The researchers conclude that with 18 in. of depth of cover under realistic field conditions, a pipe could crack under a repeat heavy load, as observed during the concrete pipe fatigue testing. In addition, the research focused only on two typical pipe materials and diameters of water lines. In reality, many other pipe diameters and materials are used in practice that could be more susceptible to damage by heavy loads. As a result, the research team strongly recommends that the current requirement of 30 in. minimum depth of cover for water, non-potable water, and sanitary sewer lines outside the pavement structure be maintained to minimize a potential fatigue effect of heavy loads on buried pipes due to repeated overweight traffic.

RECOMMENDATIONS FOR A BUSINESS PROCESS FOR TXDOT OVERWEIGHT ROUTING COORDINATION

The research team evaluated the need for a business process to coordinate TxDOT overweight routing activities between MCD and other organizational units within TxDOT. The purpose of this process was to protect critical, buried utility infrastructure from damage by repeat overweight load traffic by sharing their locations with MCD and defining a process to use this information. Researchers attempted to identify organizational units within TxDOT that have data about critical, buried utility infrastructure; attempted to identify and describe the format and content of that data; and describe a method to exchange that data among TxDOT units and integrate the information with MCD's overweight permitting process.

The research team found that currently, there is no organizational unit within TxDOT that could provide data on critical, buried utility infrastructure. Furthermore, despite several steps by the research team to reach out to the utility community, the team was unable to identify locations of critical, buried utility infrastructure. The research team concluded that given the lack of reported incidents of underground utilities damaged by overweight loads, the current process of routing

overweight loads does not appear to have an immediate negative effect on structural integrity of buried utilities. However, continued overweight loads might have a cumulative, negative effect on the structural integrity of buried utilities over time. To that effect, the research team conducted fatigue testing on buried PVC and concrete utility pipe. The results of this testing, as described in Chapter 6, showed that for the pipe material tested, there appears to be little risk for damages as a result of repeat overweight loads if the utilities are installed according to current specifications. In light of these results, the research team concludes that there does not appear to be an immediate need to modify the current business process for overweight permitting and routing.

However, the research team developed the following recommendations, including recommendations to improve coordination and communication between TxDOT divisions, regions, and districts. These recommendations also include suggestions for changes to TxDOT information systems, i.e., TxPROS. Researchers considered changes for the information systems UIR and CPS, but did not find a need for changes to UIR and found that CPS is in the process of being replaced by TxPROS.

- **Continue Outreach to Utility Owners.** TxDOT should continue to reach out to utility owners to identify buried utility facilities that may need additional protection in the future. If such a utility facility can be identified in the future, TxDOT could implement a process by which to evaluate the level needed to adequately protect the facility. In the most severe case, district personnel could recommend to block overweight traffic over the network segment in which the utility facility is located, until other measures to protect the utility can be implemented. In TxPROS, this could be achieved using a temporary restriction. District personnel could also recommend reducing overweight traffic over a particular location, which could be implemented in TxPROS using a segment impedance. In this case, district personnel would need to notify MCD routing specialists of the location of critical utility infrastructure along with the recommended plan of action. This communication could follow the current business process by which district staff notifies MCD of temporary load restrictions.
- **Continue implementation of TxPROS.** The implementation of TxPROS will allow districts to view temporary restrictions that are currently in effect. In the long term, this should help remedy the problem with temporary restrictions that are no longer needed but are still active and other communication challenges between TxDOT organizational units.
- **Establish review period for temporary restrictions and integrate into TxPROS.** Currently, there appears to be a quarterly review of temporary restrictions by MCD routing specialists. Ideally, temporary restrictions should be removed as soon as they are no longer necessary. It may be more efficient to let district staff review restrictions in their district on a regular basis, which will become feasible with the implementation of TxPROS. For example, TxPROS could send reminders for a review if a restriction has not been changed for a period of time, e.g., 2 weeks or a month.
- **Educate district staff about current business process and future business process changes.** Researchers found a need to educate stakeholders, including district staff about

the current permitting process, in particular the removal of expired temporary restrictions. The transitioning to TxPROS will provide new opportunities and challenges that should be addressed by adequate training opportunities and guidelines for district staff.

- **Develop a manual describing the business process for overweight/oversize permits.** MCD has published guidelines for overweight permitting, including guidelines for CPS, TxPROS, and general permitting references (215, 216, 217). Although these guidelines are useful, TxDOT could further benefit from a manual that would describe the permitting process including responsibilities of staff at districts, regions, and divisions. If a need would arise in the future to coordinate among right of way/utility and MCD staff to protect critical utility infrastructure, this manual could be appended to document that process.
- **Improve TxDOT communications using GroupWise features.** In meetings with MCD and district staff, researchers noted an opportunity to improve communications between MCD and district staff, which was also one of the findings from the OS/OW Working Group consisting of engineers from the north and east Texas (NETx) district and division representatives (182). TxDOT should continue making changes to the GroupWise communication system to improve communications.

RECOMMENDATIONS FOR CHANGES TO TXDOT MANUALS

The research team examined the need for changes to TxDOT manuals, including the ROW Utility Manual (218). The main purpose of this subtask was to assess the need to make changes to manuals to implement a new business process for the coordination of utility data with the overweight routing process. However, since the research team at present did not find a need to develop a business process for overweight routing coordination, the research team does not propose any changes to TxDOT manuals. However, as outlined above, the research team recommends developing a manual that would describe the TxDOT business process for overweight/oversize permits. This manual would be intended to provide further detail about this process, in addition to existing guidelines that MCD has published, to improve overall coordination between TxDOT organizational units. This manual would describe the permitting process in further detail, including responsibilities for districts, regions, and divisions following the implementation of TxDOT regional offices. If a business process to coordinate utility information between right of way/utility staff and MCD would become necessary in the future, this manual could be appended to include a guideline on how to manage and share that information.

With regard to the ROW Utility Manual, the research team does not recommend any major changes. If TxDOT develops a manual describing the permitting process for overweight/oversize traffic, this manual could be included as a reference. If a need arises in the future for utility staff to notify MCD of critical, buried utility infrastructure in the right of way, referencing the new manual would provide utility staff a guideline on how to share that information with appropriate contacts at MCD.

RECOMMENDATIONS FOR CHANGES TO THE UTILITY ACCOMMODATION RULES

Current Relevant Accommodation Rules

The installation of underground utilities within state right of way is subject to a range of federal, statewide, and industry-specific regulations or rules. The UAR specify that the design of any utility installation, adjustment, or relocation on the state right of way is the responsibility of utility owners and needs to meet a standard acceptable to TxDOT (138). Longitudinal utility installations on right of way are generally not allowed beneath any pavement including shoulders, in the center median, and in the outer separation if frontage roads exist. In the current UAR, rule §21.40 (Underground Utilities) contains installation specifications pertaining to all types of underground utility facilities allowed on state right of way.

Over time, rules have been reorganized, modified, and clarified several times, as described in detail in Chapter 3. The rules in the most recent version in general have stricter requirements on encasement and casing materials. In addition, there are some stricter or new requirements partly in response to new materials and installation techniques. Nevertheless, many technical requirements on aspects such as encasement and minimum depths of cover remained the same. Below are the major requirements pertinent to this research along with recommended changes.

Depth of Cover Requirements

The sensitivity analysis found that depth of cover was the most significant factor for predicted damage ratio. Depth of cover is a critical factor in the protection of buried utilities since loads above a buried pipe increasingly dissipate with an increase of depth of cover. In the 1979 version of the rules, existing lines with only 18 in. of depth of cover could be authorized to remain in place (Table 61 and Table 62). The current rules provide more diverse requirements for depth of cover based on the type of utility, but no requirement is less than 24 in. (Table 63 to Table 67). Under paved areas, the currently required depth of cover is in general 18 in. below the pavement structure, or 60 in. below the pavement surface, if the line is encased. Because of the 18-in. exception in 1979, the utility damage evaluation in Task 5 and Task 7 used a depth of cover of 18 in.

Modeling HS-20, HS-25, and HS-30 design trucks typically used for bridge design, the researchers found that both PVC and concrete pipes with typical pipe diameters under an unpaved surface deform within an acceptable tolerance, 5 percent of vertical diameter. These results were based on the Phase II sensitivity analysis and laboratory testing that incorporated both static and fatigue load conditions. However, during laboratory testing, the researchers observed what appears to be fatigue associated damage of concrete pipe buried at 18 in. depth of cover, even though the vertical deformation of the pipe was found to be very minimal. Researchers suspect that the crack might have initiated after the pipe came into contact with the wall openings of the soil box due to gradual differential settlement of soil and gravel. The research team was able to confirm this effect using a finite element analysis as described in Chapter 6. No backfill material was observed leaking into the pipe during the fatigue test indicating that the crack remained closed during the test.

Since current requirements for depth of cover of water and sanitary sewer utilities are 30 in., with several districts using even more stringent depth of cover requirements (163, 164, 165), the research team does not recommend a modification to the depth of cover requirements in the current version of the UAR. Researchers are of the opinion that the current requirement of 30 in. minimum depth of cover below highway ditches provides an adequate safety standard to minimize fatigue effect on buried concrete pipe due to repeated overweight traffic.

Table 61. 1979 UAR: Minimum Depth of Cover for Low Pressure Gas and Liquid Petroleum, Water, Sanitary Sewer, Electric, and Underground Communication Lines.

| Location | Encasement | Requirement |
|----------------------------|------------|--|
| Outside pavement structure | Encased | • 24 in. (18 in. for existing lines may be authorized) |
| | Unencased | • 24 in. (18 in. for existing lines may be authorized) |
| Under pavement structure | | • 18 in. or half the pipe diameter, whichever greater, beneath bottom of pavement structure (12 in. or half the pipe diameter may be authorized) |

Table 62. 1979 UAR: Minimum Depth of Cover for High Pressure Gas and Liquid Petroleum Lines.

| Location | Encasement | Requirement |
|----------------------------|------------|---|
| Outside Pavement structure | Encased | • 30 in. (24 in. for existing lines may be authorized) • 36 in. for unencased section of encased lines (30 in. for existing lines may be authorized) |
| | Unencased | • 48 in. (reduction may be authorized if reinforced concrete slab is used) |
| Under pavement structure | Encased | • 18 in. or half the pipe diameter, whichever greater, beneath bottom of pavement structure (12 in. or half the pipe diameter may be authorized) |
| | Unencased | • 60 in. under pavement surface or 18 in. under pavement structure, whichever greater |

Table 63. 2010 UAR: Minimum Depth of Cover for Low Pressure Gas and Liquid Petroleum Lines.

| Installation | Encasement | Location | Requirement |
|--------------|------------|----------------------------|---|
| Crossings | Encased | Outside pavement structure | <ul style="list-style-type: none"> • 24 in. outside pavement structure and under ditches (original unsilted flow line) • 30 in. for unencased sections of encased lines outside of pavement structure |
| | | Under pavement structure | <ul style="list-style-type: none"> • 18 in. or half the pipe diameter, whichever greater, under pavement structure (12 in. or half the pipe diameter may be authorized) |
| | Unencased | Outside pavement structure | <ul style="list-style-type: none"> • 48 in. outside paved areas and under ditches (original unsilted flow line) • a lesser depth if authorized by district where a reinforced concrete slab is used to protect the pipeline |
| | | Under pavement structure | <ul style="list-style-type: none"> • 60 in. under pavement surface or 18 in. under pavement structure for paved areas |
| Longitudinal | | | <ul style="list-style-type: none"> • 36 in. |

Table 64. 2010 UAR: Minimum Depth of Cover for Water, Non-Potable Water, and Sanitary Sewer Lines.

| Installation | Location | Requirement |
|--------------|----------------------------|---|
| Crossings | Outside pavement structure | <ul style="list-style-type: none"> • 30 in. |
| | Under pavement structure | <ul style="list-style-type: none"> • 18 in. under pavement structure for paved areas |
| Longitudinal | | <ul style="list-style-type: none"> • 30 in. |

Table 65. 2010 UAR: Minimum Depth of Cover for Electric Lines.

| Installation | Encasement | Location | Requirement |
|--------------|------------|----------------------------|---|
| Crossings | Encased | Outside pavement structure | <ul style="list-style-type: none"> • 36 in. |
| | | Under pavement structure | <ul style="list-style-type: none"> • 60 in. below pavement structure |
| Longitudinal | | | <ul style="list-style-type: none"> • 30 in. for voltage of 22,000 or less • 36 in. for voltage from 22,001 to 40,000 • 42 in. for voltage of 40,001 or greater |

Table 66. 2010 UAR: Minimum Depth of Cover for Underground Communication Lines.

| Installation | Location | Requirement |
|---------------------------|----------------------------|---|
| Cable TV and Copper Lines | Outside pavement structure | • 24 in. |
| | Under pavement structure | • 18 in. under pavement structure for paved areas |
| Fiber-optic Lines | Outside pavement structure | • 42 in. (36 in. may be authorized) |
| | Under pavement structure | • 60 in. below pavement surface or 18 in. under pavement structure for paved areas, whichever greater |

Table 67. 2010 UAR: Minimum Depth of Cover for High Pressure Gas and Liquid Petroleum Lines.

| Installation | Encasement | Location | Requirement |
|--------------|------------|----------------------------|---|
| Crossings | Encased | Outside pavement structure | <ul style="list-style-type: none"> • 30 in. outside pavement structure and under ditches (original unsilted flow line) • 36 in. for unencased sections of encased lines outside of pavement structure |
| | | Under pavement structure | • 18 in. or half the pipe diameter, whichever greater, under pavement structure (12 in. or half the pipe diameter may be authorized) |
| | Unencased | Outside pavement structure | <ul style="list-style-type: none"> • 48 in. outside paved areas and under ditches (original unsilted flow line) • a lesser depth if authorized by district where a reinforced concrete slab is used to protect the pipeline |
| | | Under pavement structure | • 60 in. under pavement surface or 18 in. under pavement structure for paved areas |
| Longitudinal | | | • 48 in. |

However, the review of the UAR found a few areas that should be reviewed for consistency and clarity. One such area is the specifications on the minimum depth of cover for electric lines. In the current version of the rules, two depth of cover regulations appear to be inconsistent: As shown in Table 65, electric lines with a voltage of 22,000 Volts or less must have a depth of cover of 30 in., but all encased electric lines crossing the highway and outside the pavement structure must have a depth of cover of 36 in. (219). As such, an encased 22,000 volt line appears to have a more stringent requirement than an unencased line.

Another requirement that may warrant review is the depth of cover for crossings of encased electric lines, which is 60 in. below the pavement *structure* (220). The current standard for crossings of all other utility lines, including high pressure gas lines, is 18 in. below the pavement structure. High pressure gas lines and underground communication lines require 60 in. below the

top of the pavement surface, so the electric line requirement was possibly intended to be measured from the top of the pavement *surface*.

Encasement Requirements

In general, the UAR specify that all underground utility lines crossing the highway must be encased. More recently, the UAR clarified encasement materials to include steel, concrete, or plastic pipe, and the strength of the encasement material to equal or exceed structural requirements for drainage culverts. The length of the encasement must be provided as follows:

- Cut sections: from the top of backslope to top of backslope.
- Fill sections: 5 ft beyond the toe of slope.
- Curb sections: 5 ft beyond the face of the curb.

The UAR also provides numerous detailed specifications for encasement based on the type of utility facility, including rules for the omission of encasement in certain areas of the highway crossing, such as center medians, under certain conditions.

The researchers expected that encased utility facilities installed at depths provided in the rules provide a strength that is insignificantly affected by overweight and superheavy traffic loads. This expectation was confirmed by the Phase 1 Utility Damage Analysis. As such, the research team did not include encased utility facilities in the Phase 2 Utility Damage Analysis. Further, it was outside the scope of this research to evaluate encasement requirements. However, in the review of the UAR the research team noted a few areas in the current rules which TxDOT should review to possibly clarify the intent of the rules.

TxDOT should review the encasement requirement for water lines, which currently allows water lines 24 in. or greater to remain in place if they comply with 30 TAC section 290.44(a) (221, 142). This rule requires a minimum depth of cover of 24 in. below ground surface, a lesser depth than 30 in., which is the current depth of cover standard for water lines outside the pavement structure. Section 290.44(a) also does not mention depth of cover requirements under pavement structures. The current general requirement for water lines of 18 in. under the pavement structure is therefore much more stringent than the general 24 in. requirement in section 290.44(a). TxDOT should consider including this more stringent requirement in section 290.44(a).

TxDOT should also review the requirement for encasement of sanitary sewer lines, which states that gravity flow lines not conforming to minimum depth of cover requirements shall be encased (222). Since there are minimum requirements in the UAR for depth of cover of encased sanitary sewer lines, it would be useful to clarify that these minimum requirements apply for encased sewer lines. Otherwise, this section could be misunderstood that encased sanitary sewer lines do not have depth of cover requirements.

Similarly, section 21.40(f)(2)(B)(iii) states that encasement may be required for underground communication lines buried at less than minimum depth, but there are minimum depth

requirements for encased underground communication lines under the pavement structure that apply (223). However, there are no minimum depth requirements for encased underground communication lines outside the pavement structure. TxDOT could consider clarifying that minimum requirements apply for encased underground communication lines under the pavement structure. TxDOT could further consider including a depth of cover requirement for encased underground communication lines outside the pavement structure similar to those of electric lines, which is currently 36 in.

REFERENCES

1. Moser, A. P. and Folkman, S. *Buried Pipe Design*. 3rd Edition, McGraw-Hill, 2008.
2. American Water Works Association. *Manual: Steel Pipe: A Guide for Design and Installation*. AWWA M11, Denver, Colorado, 2004.
3. American Water Works Association. *Steel Water Pipe - 6 In. (150 mm) and Larger*. AWWA C200, Denver, Colorado, 2005.
4. Ductile Iron Pipe Research Association, *Ductile Iron Pipe for Wastewater Applications*. Birmingham, Alabama, 2006.
5. American Water Works Association. AWWA M41. *Ductile-Iron Pipe and Fittings*. Third Edition, 2008.
6. American Water Works Association. *Manual: PVC Pipe - Design and Installation*. AWWA M23, Denver, Colorado, 2002.
7. American Water Works Association. *Fiberglass Pipe Design*. AWWA M45, Denver, Colorado, 2008.
8. American Water Works Association. *Manual: Concrete Pressure Pipe*. AWWA M9, Denver, Colorado, 2008.
9. Marston, A. and Anderson, A. O. *The Theory of Loads on Pipes in Ditches, and Tests of Cement and Clay Drain Tile and Sewer Pipe*. Bulletin No. 31, Iowa Engineering Experiment Station, Ames, Iowa, 1913.
10. Spangler, M. G. *The Structural Design of Flexible Pipe Culverts*, Iowa State College, Bulletin XL (30), 1941.
11. Watkins, R. K. and Spangler, M. G., *Some Characteristics of the Modulus of Passive Resistance of Soil: A Study in Similitude*. Procedures of the 37th Annual Meeting of the Highway Research Board, 1958, pp. 576–583.
12. Masada T. *Modified Iowa Formula for Vertical Deflection of Buried Flexible Pipe*. ASCE Journal of Transportation Engineering, Vol. 126, No. 5, pp. 440–446, 2000.
13. American Association of State Highway and Transportation Officials. *AASHTO LRFD Bridge Design Specifications, 2nd ed.* Washington, D.C., 1999.
14. McGrath, T.J. *Replacing E' with the Constrained Modulus in Buried Pipe Design*. In *Pipelines in the Constructed Environment*. Edited by J. P. Castronovo and J. A. Clark, Reston, Virginia, ASCE, 1998.
15. *Construction Details and Standard Drawings*. City of Grapevine, Texas. Obtained from <http://www.grapevintexas.gov/LinkClick.aspx?fileticket=gvDDScAE7iE%3d&tabid=371&mid=514>, 2006. Accessed August 31, 2010.
16. American Water Works Association. *Ductile-Iron Pipe, Centrifugally Cast, for Water*. AWWA C151/A21.51, Denver, Colorado, 2009.
17. *Standard for Thickness Design of Ductile-Iron Pipe*. ANSI/AWWA C150/A21.50-08, Denver, Colorado, 2008.

18. *Ductile Iron Pipe Design for Fire Protection, Water, and Wastewater*. Revised Version No. 2.04, Publication No. BRO-001, U.S. Pipe and Foundry Company, Birmingham, Alabama, 2004. Obtained from <http://www.uspipe.com/Files/20047231412260.001DuctileIronPD.pdf>. Accessed May 27, 2010.
19. *Standard for Reinforced Concrete Water Pipe-Steel Cylinder Type, Pretensioned*. ANSI/AWWA C303-78, Denver, Colorado, 1978.
20. *Standard for Pre-stressed Concrete Pressure Pipe-Steel Cylinder Type for Water and Other Liquids*. ANSI/AWWA C301-72, Denver, Colorado, 1972.
21. ASTM Standard C296, *Standard Specification for Asbestos-Cement Pressure Pipe*. American Society for Testing and Materials, Philadelphia, Pennsylvania, 2009.
22. *Standard for Asbestos – Cement Pressure Pipe, 4 in. through 16 in. (100 mm through 400 mm), for Water Distribution Systems*. ANSI/AWWA C400, Denver, Colorado, 2003.
23. American Water Works Association. *Polyvinyl Chloride (PVC) Pressure Pipe, and Fabricated Fittings, 4 in through 12 in (100 mm through 300 mm), for Water Distribution*. AWWA C900, Denver, Colorado, 2008.
24. *Blue Brute™ Class 150 Submittal and Data Sheet*. Obtained from <http://www.jmeagle.com/pdfs/2008%20Submittal%20Data%20Sheets/Blue%20Brute.pdf>. Accessed May 27, 2010.
25. American Society for Testing and Materials. *Standard Specification for Type PSM Poly (Vinyl Chloride) (PVC) Sewer Pipe and Fittings*. ASTM D 3034, West Conshohocken, Pennsylvania, 2008.
26. Gasketed PVC Sewer Pipe Datasheet. PWEagle Waterworks Products, Eugene, Oregon, 2004. Obtained from <http://www.pwpipe.com/literature/f/mkt-f-750.pdf>. Accessed May 27, 2010.
27. ASTM Standard D2412, *Standard Test Method for Determination of External Loading Characteristics of Plastic Pipe by Parallel-Plate Loading*. American Society for Testing and Materials, Philadelphia, Pennsylvania, 2011.
28. ASTM Standard C700, *Standard Specification for Vitrified Clay Pipe, Extra Strength, Standard Strength, and Perforated*. American Society for Testing and Materials, Philadelphia, Pennsylvania, 2011.
29. *Construction Standard*. City of Grapevine, Texas, 2006. Obtained from <http://www.grapevintexas.gov/LinkClick.aspx?fileticket=HGg4rYsW8is%3d&tabid=371&mid=514>. Accessed August 31, 2010.
30. *Public Works Design Manual*. City of North Richland Hills, Texas, 2009. Obtained from http://www.nrhtx.com/pdf/PW_DesignManual/NRH%202009%20PW%20Design%20Manual.pdf. Accessed August 31, 2010.
31. *Blue Brute™ Class 165, Class 235, and Class 305 Submittal and Data Sheet*. Obtained from www.jmeagle.com/pdfs/2008%20Brochures/Blue%20Brute_web.pdf. Accessed May 27, 2010.

32. Texas Commission on Environmental Quality, Austin, Texas, 2010. Obtained from <http://www.tceq.state.tx.us>. Accessed May 27, 2010.
33. ASTM Standard C76, *Standard Specification for Reinforced Concrete Culvert, Storm Drain, and Sewer Pipe*. American Society for Testing and Materials, Philadelphia, Pennsylvania, 2011.
34. ASTM Standard D698, *Standard Test Methods for Laboratory Compaction Characteristics of Soil Using Standard Effort*. American Society for Testing and Materials, Philadelphia, Pennsylvania, 2007.
35. American Water Works Association. *Ductile-Iron and Gray-Iron Fittings for Water*. AWWA C110/A21.10, Denver, Colorado, 2008.
36. American Water Works Association. *Rubber-Gasket Joints for Ductile-Iron Pressure Pipe and Fittings*. AWWA C111/A21.11, Denver, Colorado, 2007.
37. *Ductile Iron Concrete and Steel Pipe Specification*. City of Fort Worth, Texas, 2004.
38. American Water Works Association. *Concrete Pressure Pipe, Bar-Wrapped, Steel-Cylinder Type*. AWWA C303, Denver, Colorado, 2008.
39. American Society of Mechanical Engineers. *Welded and Seamless Wrought Steel Pipe*. ASME B36.10M-2004, New York, New York, 2004.
40. American Society for Testing and Materials. *Standard Specification for Seamless Copper Water Tube*. ASTM B88, West Conshohocken, Pennsylvania, 2009.
41. American Water Works Association. *Underground Service Line Valves and Fittings*. AWWA C800-05, Denver, Colorado, 2005.
42. American Society for Testing and Materials. *Standard Specification for Poly (Vinyl Chloride) (PVC) Pressure-Rated Pipe (SDR Series)*. ASTM D 2241, West Conshohocken, Pennsylvania, 2009.
43. American Society for Testing and Materials. *Standard Specification for Poly (Vinyl Chloride) (PVC), Plastic Pipe, Schedules 40, 80, and 120*. ASTM D 1785, West Conshohocken, Pennsylvania, 2006.
44. American Society for Testing and Materials. *Standard Specification for Polyethylene (PE) Plastic Pipe (DR-PR) Based on Controller Outside Diameter*. ASTM D3035-08, West Conshohocken, Pennsylvania, 2008.
45. American Water Works Association. *Polyethylene (PE) Pressure Pipe and Tubing, 1/2 in (13mm) through 3 in (76 mm), for Water Service*. AWWA C901, Denver, Colorado, 2008.
46. American Water Works Association. *Polyethylene (PE) Pressure Pipe and Fittings, 4 in (100 mm) through 63 in, (1,575 mm) for Water Distribution and Transmission*. AWWA C906, Denver, Colorado, 2007.
47. Unified Facilities Guide Specifications. *Water Distribution*. UFGS-33 11 00, National Institute of Building Sciences, Washington, D.C., 2009.
48. Unified Facilities Criteria. *Water Supply: Water Distribution*. UFC 3-230-10A, U.S. Department of Defense, U.S. Corps of Engineers, Washington, D.C., 2004.
49. Unified Facilities Guide Specifications. *Cathodic Protection by Galvanic Anodes*. UFGS-26 42 13.00 20, National Institute of Building Sciences, Washington, D.C., 2006.

50. American Water Works Association. *Cement-Mortar Lining for Ductile-Iron Pipe and Fittings for Water*. AWWA C104/A21.4, Denver, Colorado, 2008.
51. American Water Works Association. *Polyethylene Encasement for Ductile-Iron Pipe Systems*. AWWA C105/A21.5, Denver, Colorado, 2005.
52. American Society for Testing and Materials. *Resistance to Short-Time Hydraulic Failure Pressure of Plastic Pipe, Tubing, and Fittings*. ASTM D 1599, West Conshohocken, Pennsylvania, 2005.
53. American Society for Testing and Materials. *Filament-Wound "Fiberglass" (Glass-Fiber-Reinforced Thermosetting-Resin) Pipe*. ASTM D 2996, West Conshohocken, Pennsylvania, 2007.
54. American Society for Testing and Materials. *Centrifugally Cast "Fiberglass" (Glass-Fiber-Reinforced Thermosetting-Resin) Pipe*. ASTM D 2997, West Conshohocken, Pennsylvania, 2007.
55. American Water Works Association. *Fiberglass Pressure Pipe*. AWWA C950, Denver, Colorado, 2007.
56. American Water Works Association. *Reinforced Concrete Pressure Pipe, Steel-Cylinder Type*. AWWA C300, Denver, Colorado, 2004.
57. American Water Works Association. *Pre-stressed Concrete Pressure Pipe, Steel-Cylinder Type*. AWWA C301, Denver, Colorado, 2007.
58. American Water Works Association. *Standard for Liquid Epoxy Coating Systems for the Interior and Exterior of Steel Water Pipelines*. AWWA C210, Denver, Colorado, 2007.
59. American Water Works Association. *Cement-Mortar Lining of Water Pipelines in Place-4 In. (100 mm) and Larger*. AWWA C602-06, Denver, Colorado, 2006.
60. American Water Works Association. *Cement-Mortar Protective Lining and Coating for Steel Water Pipe - 4 In. (100 mm) and Larger - Shop Applied*. AWWA C205, Denver, Colorado, 2007.
61. American Water Works Association. *Coal-Tar Protective Coatings and Linings for Steel Water Pipelines – Enamel and Tape – Hot-Applied*. AWWA C203, Denver, Colorado, 2008.
62. American Society for Testing and Materials. *Standard Specification for Seamless Copper Pipe, Standard Sizes*. ASTM B 42, West Conshohocken, Pennsylvania, 2002.
63. American Society of Mechanical Engineers. *Cast Bronze Alloy Threaded Fittings Classes 125 and 250*. ASME B16.15, New York, New York, 2006.
64. American Society of Mechanical Engineers. *Cast Copper Alloy Solder Joint Pressure Fittings*. ASME B16.18, New York, New York, 2005.
65. American Society of Mechanical Engineers. *Standard for Wrought Copper and Copper Alloy Solder Joint Pressure Fittings*. ASME B16.22, New York, New York, 2005.
66. American Society of Mechanical Engineers. *Standard for Cast Copper Alloy Fittings for Flared Copper Tubes*. ASME B16.26, New York, New York, 2006.

67. American Society for Testing and Materials. *Standard Specification for Poly (Vinyl Chloride) (PVC) Plastic Pipe Fittings, Schedule 40*. ASTM D 2466, West Conshohocken, Pennsylvania, 2006.
68. American Society for Testing and Materials. *Standard Specification for Poly (Vinyl Chloride) (PVC) Plastic Pipe Fittings, Schedule 80*. ASTM D 2467, West Conshohocken, Pennsylvania, 2006.
69. American Society for Testing and Materials. *Standard Specification for Acrylonitrile-Butadiene-Styrene (ABS) Plastic Pipe, Schedules 40 and 80*. ASTM D 1527, West Conshohocken, Pennsylvania, 2005.
70. American Society for Testing and Materials. *Acrylonitrile-Butadiene-Styrene (ABS) Plastic Pipe (SDR-PR)*. ASTM D 2282, West Conshohocken, Pennsylvania, 2005.
71. American Society for Testing and Materials. *Acrylonitrile-Butadiene-Styrene (ABS) Plastic Pipe Fittings, Schedule 40*. ASTM D 2468, West Conshohocken, Pennsylvania, 1996.
72. American Society for Testing and Materials. *Standard Specification for Solvent Cement for Acrylonitrile-Butadiene-Styrene (ABS) Plastic Pipe and Fittings*. ASTM D 2235, West Conshohocken, Pennsylvania, 2004.
73. American Water Works Association. *Molecularly Oriented Polyvinyl Chloride (PVCO) Pressure Pipe, 4 in through 12 in (100 mm through 300 mm), for Water Distribution*. AWWA C909, Denver, Colorado, 2002.
74. American Society for Testing and Materials. *"Fiberglass" (Glass-Fiber-Reinforced Thermosetting-Resin) Pipe Joints Using Flexible Elastomeric Seals*. ASTM D 4161, West Conshohocken, Pennsylvania, 2005.
75. American Society for Testing and Materials. *Standard Specification for Pipe, Steel, Black and Hot-Dipped, Zinc-Coated, Welded and Seamless*. ASTM A 53, West Conshohocken, Pennsylvania, 2007.
76. American Society for Testing and Materials. *Standard Specification for Pipe, Steel, Black and Hot-Dipped, Zinc-Coated, Welded and Seamless (Metric)*. ASTM A 53M, West Conshohocken, Pennsylvania, 2007.
77. American Society of Mechanical Engineers. *Standard for Gray Iron Threaded Fittings; Classes 125 and 250*. ASME B16.4, New York, New York, 2006.
78. American Society of Mechanical Engineers. *Malleable Iron Threaded Fittings, Classes 150 and 300*. ASME B16.3, New York, New York, 2006.
79. American Water Works Association. *Installation of Ductile-Iron Water Mains and Their Appurtenances*. AWWA C600, Denver, Colorado, 2005.
80. American Society for Testing and Materials. *Laboratory Compaction Characteristics of Soil Using Standard Effort (12,000 ft-lbf/ft³) (600 kNm/m³)*. ASTM D 698, West Conshohocken, Pennsylvania, 2007.
81. American Society for Testing and Materials. *Standard Practice for Underground Installation of Thermoplastic Pipe for Sewers and Other Gravity-Flow Applications*. ASTM D 2321, West Conshohocken, Pennsylvania, 2008.
82. American Society for Testing and Materials. *Soils for Engineering Purposes (Unified Soil Classification System)*. ASTM D 2487, West Conshohocken, Pennsylvania, 2006.

83. American Society for Testing and Materials. *Standard Specification for Electric-Fusion (ARC)-Welded Steel Pipe (NPS 4 and over)*. ASTM A 139, West Conshohocken, Pennsylvania, 2004.
84. American Society for Testing and Materials. *Standard Specification for Electric-Fusion (ARC)-Welded Steel Pipe (NPS 4 and over, Metric)*. ASTM A 139M, West Conshohocken, Pennsylvania, 2004.
85. American Society for Testing and Materials. *Standard Specification for Welded and Seamless Steel Pipe Piles*. ASTM A 252, West Conshohocken, Pennsylvania, 2007.
86. American Welding Society. *Structural Welding Code – Steel*. AWS D1.1/D1.1M, Miami, Florida, 2008.
87. American Society for Testing and Materials. *Standard Specification for Ready-Mixed Concrete*. ASTM C 94, West Conshohocken, Pennsylvania, 2009.
88. American Society for Testing and Materials. *Standard Specification for Ready-Mixed Concrete (Metric)*. ASTM C 94M, West Conshohocken, Pennsylvania, 2009.
89. National Fire Protection Association. *Standard for the Installation of Private Fire Service Mains and Their Appurtenances*. NFPA 24, Quincy, Massachusetts, 2010.
90. Uni-Bell PVC Pipe Association. *Recommended Practice for the Installation of Polyvinyl Chloride (PVC) Pressure Pipe (Nominal Diameters 4-36 inches)*. UBPPA UNI-B-3, Dallas, Texas, 1992.
91. American Water Works Association. *Underground Installation of Polyvinyl Chloride (PVC) Pressure Pipe and Fittings for Water*. AWWA C605, Denver, Colorado, 2005.
92. American Society for Testing and Materials. *Underground Installation of Thermoplastic Pressure Piping*. ASTM D 2774, West Conshohocken, Pennsylvania, 2008.
93. American Society for Testing and Materials. *Underground Installation of "Fiberglass" (Glass-Fiber-Reinforced Thermosetting-Resin) Pipe*. ASTM D 3839, West Conshohocken, Pennsylvania, 2008.
94. American Water Works Association. *Field Welding of Steel Water Pipe*. AWWA C206-03, Denver, Colorado, 2005.
95. American Society for Testing and Materials. *Standard Practice for Making Solvent-Cemented Joints with Poly(Vinyl Chloride) (PVC) Pipe and Fittings*. ASTM D2855, West Conshohocken, Pennsylvania, 2002.
96. American Society for Testing and Materials. *Safe Handling of Solvent Cements, Primers, and Cleaners Used for Joining Thermoplastic Pipe and Fittings*. ASTM F 402, West Conshohocken, Pennsylvania, 2005.
97. Unified Facilities Guide Specifications. *Sanitary Sewers*. UFGS-33 30 00, National Institute of Building Sciences, Washington, D.C., 2008.
98. Unified Facilities Guide Specifications. *Natural Gas and Liquid Petroleum Piping*. UFGS-33 11 23, National Institute of Building Sciences, Washington, D.C., 2009.
99. American Society of Mechanical Engineers. *Gas Transmission and Distribution Piping Systems*. ASME B31.8-2010, New York, New York, 2010.

100. American Society for Testing and Materials. *Standard Specification for Polyethylene (PE) Gas Pressure Pipe, Tubing, and Fittings*. ASTM D2513, West Conshohocken, Pennsylvania, 2009.
101. Unified Facilities Guide Specifications. *Earthwork*. UFGS-31 00 00, National Institute of Building Sciences, Washington, D.C., 2008.
102. American Society for Testing and Materials. *Standard Test Methods for Laboratory Compaction Characteristics of Soil Using Modified Effort (56,000 ft-lbf/ft³) (2700 kNm/m³)*. ASTM D1557, West Conshohocken, Pennsylvania, 2009.
103. American Association of State Highway and Transportation Officials. *Standard Method of Test for Moisture-Density Relations of Soils Using a 4.54-kg (10-lb) Rammer and a 457-mm (18-in.) Drop*. AASHTO T 180, Washington, D.C., 2009.
104. American Association of State Highway and Transportation Officials. *Correction for Coarse Particles in the Soil Compaction Test*. AASHTO T 224, Washington, D.C., 2004.
105. National Clay Pipe Institute. *Clay Pipe Engineering Manual*. Lake Geneva, Wisconsin, 1985.
106. American Concrete Pipe Association. *Concrete Pipe Design Manual*. Irving, Texas, 1980.
107. American Concrete Pipe Association. *Concrete Pipe Handbook*. Irving, Texas, 1980.
108. American Society for Testing and Materials. *Standard Specification for Reinforced Concrete Arch Culvert, Storm Drain, and Sewer Pipe*. ASTM C 506, West Conshohocken, Pennsylvania, 2009.
109. American Society for Testing and Materials. *Standard Specification for Reinforced Concrete Elliptical Culvert, Storm Drain, and Sewer Pipe*. ASTM C 507, West Conshohocken, Pennsylvania, 2009.
110. American Society of Civil Engineers. *Design and Construction of Sanitary and Storm Sewers*. ASCE Manual of Engineering Practice No. 37, Reston, Virginia, 1983.
111. American Society for Testing and Materials. *Standard Specification for Reinforced Concrete Low-Head Pressure Pipe*. ASTM C 361, West Conshohocken, Pennsylvania, 2008.
112. American Society for Testing and Materials. *Standard Specification for Reinforced Concrete Low-Head Pressure Pipe (Metric)*. ASTM C 361M, West Conshohocken, Pennsylvania, 2008.
113. American Water Works Association. *Reinforced Concrete Pressure Pipe, Non-cylinder Type*. AWWA C302, Denver, Colorado, 2004.
114. American Society for Testing and Materials. *Standard Specification for Ductile Iron Gravity Sewer Pipe*. ASTM A 746, West Conshohocken, Pennsylvania, 2009.
115. American Society for Testing and Materials. *Standard Specification for Mortar for Unit Masonry*. ASTM C 270, West Conshohocken, Pennsylvania, 2008.
116. American Society for Testing and Materials. *Standard Specification for Portland Cement*. ASTM C 150, West Conshohocken, Pennsylvania, 2009.
117. American Society for Testing and Materials. *Standard Specification for Portland Cement (Metric)*. ASTM C 150M, West Conshohocken, Pennsylvania, 2009.

118. American Society for Testing and Materials. *Standard Specification for Air-Entraining Admixtures for Concrete*. ASTM C 260, West Conshohocken, Pennsylvania, 2006.
119. American Society for Testing and Materials. *Standard Specification for Concrete Aggregates*. ASTM C 33, West Conshohocken, Pennsylvania, 2008.
120. American Society for Testing and Materials. *Standard Specification for Concrete Aggregates (Metric)*. ASTM C 33M, West Conshohocken, Pennsylvania, 2008.
121. American Society for Testing and Materials. *Standard Specification for Concrete Sewer, Storm Drain, and Culvert Pipe*. ASTM C 14, West Conshohocken, Pennsylvania, 2007.
122. American Society for Testing and Materials. *Standard Specification for Concrete Sewer, Storm Drain, and Culvert Pipe (Metric)*. ASTM C 14M, West Conshohocken, Pennsylvania, 2007.
123. American Society for Testing and Materials. *Standard Specification for Reinforced Concrete Culvert, Storm Drain, and Sewer Pipe*. ASTM C 76, West Conshohocken, Pennsylvania, 2008.
124. American Society for Testing and Materials. *Standard Specification for Reinforced Concrete Culvert, Storm Drain, and Sewer Pipe (Metric)*. ASTM C 76M, West Conshohocken, Pennsylvania, 2008.
125. American Water Works Association. *Flanged Ductile-Iron Pipe with Ductile-Iron or Gray-Iron Threaded Flanges*. AWWA C115/A21.15, Denver, Colorado, 2005.
126. American Society for Testing and Materials. *Standard Specification for Acrylonitrile-Butadiene-Styrene (ABS) and Poly (Vinyl Chloride) (PVC) Composite Sewer Piping*. ASTM D 2680, West Conshohocken, Pennsylvania, 2009.
127. American Society for Testing and Materials. *Standard Specification for Acrylonitrile-Butadiene-Styrene (ABS) Sewer Pipe and Fittings*. ASTM D 2751, West Conshohocken, Pennsylvania, 2005.
128. American Society for Testing and Materials. *Standard Specification for Joints for Drain and Sewer Plastic Pipes Using Flexible Elastomeric Seals*. ASTM D 3212, West Conshohocken, Pennsylvania, 2007.
129. American Society for Testing and Materials. *Standard Specification for Elastomeric Seals (Gaskets) for Joining Plastic Pipe*. ASTM F 477, West Conshohocken, Pennsylvania, 2008.
130. American Society for Testing and Materials. *Poly (Vinyl Chloride) (PVC) Corrugated Sewer Pipe with a Smooth Interior and Fittings*. ASTM F 949, West Conshohocken, Pennsylvania, 2009.
131. American Society for Testing and Materials. *Standard Specification for Poly (Vinyl Chloride) (PVC) Profile Gravity Sewer Pipe and Fittings Based on Controlled Inside Diameter*. ASTM F 794, West Conshohocken, Pennsylvania, 2003.
132. American Society for Testing and Materials. *Standard Specification for Rigid Poly (Vinyl Chloride) (PVC) Compounds and Chlorinated Poly (Vinyl Chloride) (CPVC) Compounds*. ASTM D 1784, West Conshohocken, Pennsylvania, 2008.
133. American Water Works Association. *Ductile-Iron Compact Fittings for Water Service*. AWWA C153/A21.53, Denver, Colorado, 2006.

134. American Society for Testing and Materials. *Polyethylene (PE) Large Diameter Profile Wall Sewer and Drain Pipe*. ASTM F 894, West Conshohocken, Pennsylvania, 2007.
135. American Society for Testing and Materials. *Polyethylene (PE) Plastic Pipe (SDR-PR) Based on Outside Diameter*. ASTM F 714, West Conshohocken, Pennsylvania, 2008.
136. American Society for Testing and Materials. *Polyethylene Plastics Pipe and Fittings Materials*. ASTM D 3350, West Conshohocken, Pennsylvania, 2008.
137. American Society for Testing and Materials. *"Fiberglass" (Glass-Fiber-Reinforced Thermosetting-Resin) Sewer Pipe*. ASTM D 3262, West Conshohocken, Pennsylvania, 2006.
138. *Utility Accommodation Rules*. Texas Administrative Code, Title 43, Transportation, Part 1, Texas Department of Transportation, Chapter 21, Right of way, Subchapter C. Obtained from [http://info.sos.state.tx.us/pls/pub/readtac\\$ext.ViewTAC?tac_view=5&ti=43&pt=1&ch=21&sch=C&rl=Y](http://info.sos.state.tx.us/pls/pub/readtac$ext.ViewTAC?tac_view=5&ti=43&pt=1&ch=21&sch=C&rl=Y). Accessed October 30, 2009.
139. *National Electrical Safety Code*. C2-2007. Institute of Electrical and Electronics Engineers (IEEE), 2007.
140. *Transportation of Natural and Other Gas by Pipeline: Minimum Federal Safety Standards*. Code of Federal Regulations, Title 49, Part 192. Obtained from http://ecfr.gpoaccess.gov/cgi/t/text/text-idx?c=ecfr&tpl=/ecfrbrowse/Title49/49cfr192_main_02.tpl. Accessed April 6, 2010.
141. *Transportation of Hazardous Liquids by Pipeline*. Code of Federal Regulations, Title 49, Part 195. Obtained from <http://ecfr.gpoaccess.gov/cgi/t/text/text-idx?c=ecfr;sid=401b4eb1be38062dcd29668ef6ee1e09;rgn=div5;view=text;node=49%3A3.1.1.1.7;idno=49;cc=ecfr>. Accessed April 6, 2010.
142. *Rules and Regulations for Public Water Systems*. Texas Administrative Code, Title 30, Chapter 290, Subchapter D. Obtained from [http://info.sos.state.tx.us/pls/pub/readtac\\$ext.ViewTAC?tac_view=5&ti=30&pt=1&ch=290&sch=D&rl=Y](http://info.sos.state.tx.us/pls/pub/readtac$ext.ViewTAC?tac_view=5&ti=30&pt=1&ch=290&sch=D&rl=Y). Accessed April 6, 2010.
143. *Utility Policies*. Texas Highway Department. Accessed March 15, 2010. Unpublished document.
144. *Accommodation of Utilities*. Code of Federal Regulations Title 23, Chapter I, Part 645B. Obtained from <http://www.gpoaccess.gov/cfr/index.html>. Accessed Feb. 4, 2010.
145. *A Policy on the Accommodation of Utilities within Freeway Right of Way*. American Association of Highway Transportation Officials Technical Committee on Geometric Design. Washington D.C., 2005.
146. *A Guide for Accommodating Utilities within Highway Right of Way*. American Association of Highway Transportation Officials Technical Committee on Geometric Design. Washington D.C., 2005.
147. *Highway/Utility Guide*. American Public Works Association and University of Alabama Department of Civil Engineering. Kansas City, 1993.

148. *RAC Operation Guideline*. Texas Department of State Health Services. Obtained from http://www.dshs.state.tx.us/emstraumasystems/TexasAdministrativeCodes&EMSTraumaSystemRules06_2008.pdf. Accessed Nov. 24, 2009.
149. *Texas Register*. Special Issue, October 20, 1997. Office of the Secretary of State, Austin, Texas, pp. 38–39.
150. Texas Administrative Code, Title 43: Transportation, Chapter 21: Right of Way Division. October 1979, pp. 56–82.
151. *Texas Register 7*. Office of the Secretary of State, Austin, Texas, May 1982, pp. 1952–1953.
152. *Texas Register 14(35)*. Office of the Secretary of State, Austin, Texas, May 1989, pp. 2366–2371.
153. *Texas Register 15(49)*. Office of the Secretary of State, Austin, Texas, June 1996, p. 3751.
154. *Texas Register 21(48)*. Office of the Secretary of State, Austin, Texas, December 1996, p. 5980.
155. *Texas Register 22(27)*. Office of the Secretary of State, Austin, Texas, December 1997, pp. 3443–3444.
156. *Texas Register 23(49)*. Office of the Secretary of State, Austin, Texas, December 1998, pp. 12474–12475.
157. *Texas Register 24(8)*. Office of the Secretary of State, Austin, Texas, December 1999, pp. 1220–1221.
158. *Texas Register 26(10)*. Office of the Secretary of State, Austin, Texas, December 2001, p. 2055.
159. *Texas Register 30(10)*. Office of the Secretary of State, Austin, Texas, December 2005, pp. 1466–1474.
160. *Texas Register, 33(49)*. Office of the Secretary of State, Austin, Texas, December 2008, pp. 10066–10068.
161. *Texas Register, 34(37)*. Office of the Secretary of State, Austin, Texas, September 2009, pp. 6308–6311.
162. *Texas Register, 34 (49)*. Office of the Secretary of State, Austin, Texas, September 2009, pp. 8795–8800.
163. Special Provisions for TxDOT – San Antonio District Utility Permits. Texas Department of Transportation, San Antonio District, San Antonio, Texas, March 2009.
164. Special Provisions for TxDOT – Bryan District Utility Permits. Texas Department of Transportation, Bryan District, Bryan, Texas, April 2007.
165. Minimum Depth of Cover Table (For Underground Utilities on Highway Right of Way). Texas Department of Transportation, Pharr District, Pharr, Texas, October 2009.
166. 23 USC 127. U.S. Code, Title 23, Chapter 1, Sections 127. <http://www.gpoaccess.gov/uscode/>. Accessed March 29, 2010.
167. 23 CFR 657. Code of Federal Regulations, Title 23, Part 657, Certification of Size and Weight Enforcement.

- http://www.access.gpo.gov/nara/cfr/waisidx_09/23cfr657_09.html. Accessed March 29, 2010.
168. 23 CFR 658. Code of Federal Regulations, Title 23, Part 658, Truck Size and Weight, Route Designations – Length, Width, and Weight Limitations.
http://www.access.gpo.gov/nara/cfr/waisidx_09/23cfr658_09.html. Accessed March 29, 2010.
 169. 7 TTC 643. Texas Transportation Code. Title 7, Subtitle F, Chapter 643, Motor Carrier Registration. <http://www.statutes.legis.state.tx.us/Docs/TN/htm/TN.643.htm>. Accessed March 29, 2010.
 170. 7 TTC 645. Texas Transportation Code. Title 7, Subtitle F, Chapter 645, Single State Registration. <http://www.statutes.legis.state.tx.us/Docs/TN/htm/TN.645.htm>. Accessed March 29, 2010.
 171. 7 TTC 646. Texas Transportation Code. Title 7, Subtitle F, Chapter 646, Motor Carrier Brokers. <http://www.statutes.legis.state.tx.us/Docs/TN/htm/TN.646.htm>. Accessed March 29, 2010.
 172. 6 TTC 201. Texas Transportation Code. Title 6, Subtitle A, Chapter 201, General Provisions and Administration.
<http://www.statutes.legis.state.tx.us/Docs/TN/htm/TN.201.htm>. Accessed March 29, 2010.
 173. 6 TTC 370. Texas Transportation Code. Title 6, Subtitle G, Chapter 370, Regional Mobility Authorities.
<http://www.statutes.legis.state.tx.us/Docs/TN/htm/TN.370.htm><http://www.statutes.legis.state.tx.us/Docs/TN/htm/TN.646.htm> Accessed March 29, 2010.
 174. 7 TTC 621. Texas Transportation Code. Title 7, Subtitle E, Chapter 621, General Provisions Relating to Vehicle Size and Weight.
<http://www.statutes.legis.state.tx.us/Docs/TN/htm/TN.621.htm>. Accessed March 29, 2010.
 175. 7 TTC 622. Texas Transportation Code. Title 7, Subtitle E, Chapter 622, Special Provisions and Exceptions for Oversize and Overweight Vehicles.
<http://www.statutes.legis.state.tx.us/Docs/TN/htm/TN.622.htm>. Accessed March 29, 2010.
 176. 7 TTC 623. Texas Transportation Code. Title 7, Subtitle E, Chapter 623, Permits for Oversize and Overweight Vehicles.
<http://www.statutes.legis.state.tx.us/Docs/TN/htm/TN.623.htm>. Accessed March 29, 2010.
 177. 43 TAC 18. Texas Administrative Code. Title 43, Part 1, Chapter 18, Motor Carriers.
[http://info.sos.state.tx.us/pls/pub/readtac\\$ext.ViewTAC?tac_view=4&ti=43&pt=1&ch=18](http://info.sos.state.tx.us/pls/pub/readtac$ext.ViewTAC?tac_view=4&ti=43&pt=1&ch=18). Accessed March 29, 2010.
 178. 43 TAC 28. Texas Administrative Code. Title 43, Part 1, Chapter 28, Oversize and Overweight Vehicles and Loads.
[http://info.sos.state.tx.us/pls/pub/readtac\\$ext.ViewTAC?tac_view=4&ti=43&pt=1&ch=28](http://info.sos.state.tx.us/pls/pub/readtac$ext.ViewTAC?tac_view=4&ti=43&pt=1&ch=28). Accessed March 29, 2010.
 179. 43 TAC 28.10. Texas Administrative Code. Title 43, Part 1, Chapter 28, Section 28.10, Purpose and Scope.

- [http://info.sos.state.tx.us/pls/pub/readtac\\$ext.TacPage?sl=R&app=9&p_dir=&p_rloc=&p_tloc=&p_ploc=&pg=1&p_tac=&ti=43&pt=1&ch=28&rl=10](http://info.sos.state.tx.us/pls/pub/readtac$ext.TacPage?sl=R&app=9&p_dir=&p_rloc=&p_tloc=&p_ploc=&pg=1&p_tac=&ti=43&pt=1&ch=28&rl=10). Accessed March 29, 2010.
180. 7 TTC 502. Texas Transportation Code. Title 7, Subtitle A, Chapter 502, Registration of Vehicles. <http://www.statutes.legis.state.tx.us/Docs/TN/htm/TN.502.htm>. Accessed March 29, 2010.
 181. *Permit Officer's Reference Guide*. Motor Carrier Division, Texas Department of Transportation, Austin, Texas, April 2007.
 182. *Recommendations of the Overweight/Oversize Work Group*. North & East Texas Maintenance Operations Group, Texas Department of Transportation, Tyler, Texas, November 23, 2006.
 183. *GeoMerge Geoprocessing Utility*. VDS Technologies, Dover, Delaware, 2011. <http://www.vdstech.com/geomerge.htm>. Accessed August 17, 2011.
 184. *LexisNexis Academic and Library Solutions – LexisNexis Academic*. Reed Elsevier Inc. Obtained from <http://academic.lexisnexis.com/online-services/academic/academic-overview.aspx>. Accessed April 10, 2010.
 185. *Houston Chronicle*. Obtained from <http://www.chron.com/>. Accessed June 23, 2010.
 186. *Corpus Christi Caller-Times*. Obtained from <http://www.caller.com/>. Accessed June 23, 2010.
 187. *San Antonio Express-News*. Obtained from <http://www.mysanantonio.com/>. Accessed June 23, 2010.
 188. *Fort Worth Star-Telegram*. Obtained from <http://www.star-telegram.com/>. Accessed June 23, 2010.
 189. *Abilene Reporter News*. Obtained from <http://www.reporternews.com/>. Accessed June 23, 2010.
 190. *Beaumont Enterprise*. Obtained from <http://www.usnpl.com/txnews.php>. Accessed June 23, 2010.
 191. *Port Arthur News*. Obtained from <http://panews.com/>. Accessed June 23, 2010.
 192. *Underground Focus Magazine*. Obtained from http://www.underspace.com/UFM_files/current_issue.html. Accessed June 23, 2010.
 193. *Accident File Archive*. Underground Focus Magazine. Obtained from http://www.underspace.com/UFM_files/accident_bulletin/accident.php. Accessed June 23, 2010.
 194. *About UIR*. UIR Online Help for Installation Owner Users. Obtained from https://apps.dot.state.tx.us/uirpro/UIR_HELP/UtilityCompany/UIR_Online_Help_System.htm. Accessed June 30, 2010.
 195. Mlynarski, M., Katona, M. G., and McGrath, T. J. *Modernize and Upgrade CANDE for Analysis and LRFD Design of Buried Structures*. NCHRP Report 619, 2008. <http://144.171.11.40/cmsfeed/TRBNetProjectDisplay.asp?ProjectID=408>. Accessed October 23, 2009.
 196. Katona, M. G. and Smith, J. M., *CANDE User and System Manuals*. Federal Highway Administration Report No. FHWA-RD-77-6, 1976.

197. Peterson, D. L., Nelson, C.R., Li, G., McGrath, T. J., and Kitane, Y. *Recommended Design Specifications for Live Load Distribution to Buried Structures*. NCHRP Report 647, 2010.
198. Watkins, R. K. and Reeve, R. C. *Effect of Heavy Loads on Buried Corrugated Polyethylene Pipe*. Advanced Drainage Systems, Inc., Columbus, Ohio, 1982.
199. Arockiasamy, M., Chaallal, O., and Limpeteeparakarn, T. *Full-Scale Field Tests on Flexible Pipes Under Live Load Application*. Journal of Performance of Constructed Facilities, Volume 20, No. 1, ASCE, pp. 21–27, 2006.
200. Bridge Design Manual – LRFD. Texas Department of Transportation, Austin, Texas, October 2010. <http://onlinemanuals.txdot.gov/txdotmanuals/lrf/index.htm>. Accessed August 15, 2011.
201. American Association of State Highway and Transportation Officials. *Standard Specifications for Highway Bridges*, 17th ed., Washington, D.C., 2002.
202. American Association of State Highway and Transportation Officials. *LRFD Bridge Design Specifications*, 5th ed., Washington, D.C., 2010.
203. Faragher, E., Fleming, P. R., and Rogers, C. D. F. *Analysis of Repeated-Load Field Testing of Buried Plastic Pipes*. Journal of Transportation Engineering, American Society of Civil Engineers, Vol. 126, No. 3, pp. 271–277, 2000.
204. Gondle, R. and Siriwardane, H. *Finite Element Modeling of Long Term Performance of Buried Pipes*. The 12th International Conference of International Association for Computer Methods and Advances in Geomechanics (IACMAG), pp. 3993–4000. Goa, India, 2008.
205. Hashash, N. *Design and Analysis of Deeply Buried Polyethylene Drainage Pipes*. Ph.D. Thesis, Department of Civil Engineering, University of Massachusetts, 1991.
206. Yoo, C. S., Lee, K. M., Chung, S. W., and Kim, J. S. *Interaction between Flexible Buried Pipe and Surface Load*. Journal of Korean Geotechnical Engineering, KGS, Vol. 15, No. 3, pp. 83–97, 1999.
207. Cho, S. and Vipulanandan, C. *Flowable Backfill with Flexible Pipe in Trench Condition and FEM Verification*. Proceeding Paper of Pipelines 2005: Optimizing Pipeline Design, Operations, and Maintenance in Today's Economy, pp. 1079 – 1088, 2005.
208. *Mechanistic-Empirical Pavement Design Guide Program-Version 1.1*. National Cooperative Highway Research Project Number 1-37A, Transportation Research Board, National Academies of Sciences, Washington, D.C., 2009.
209. De Jong, D. L., Peutz, M. G. F., and Korswagen, A. R. *Computer Program BISAR*. External Report, Koninklijke/Shell-Laboratorium, The Netherlands, 1973.
210. CORR-21[®] PVC Gravity Sewer & Storm Drain, Diamond Plastics Corp. Obtained from http://www.dpcpipe.com/pdf/prod_corr_catalog.pdf. Accessed June 29, 2011.
211. Fernando, N. S. M. and Carter, J. P. *Elastic Analysis of Buried Pipes under Surface Patch Loadings*. Journal of Geotechnical and Geoenvironmental Engineering, American Society of Civil Engineers, Vol. 124, No. 8, pp. 720–728, 1998.

212. Kim, M., Tutumluer, E., and Mishra, D. *Flexible Pavement Response to Multiple Wheel Loading using Nonlinear Three-Dimensional Finite Element Analysis*. The 12th International Conference of International Association for Computer Methods and Advances in Geomechanics (IACMAG), Goa, India, pp. 4377–4384, 2008.
213. Peterson, D. L., Nelson, C.R., Li, G., McGrath, T. J., and Kitane, Y. *Recommended Design Specifications for Live Load Distribution to Buried Structures*. National Cooperative Highway Research Project Report 647, Transportation Research Board, National Academies of Sciences, Washington, D.C., 2010.
214. Sezen, H., Yeau, K. Y., and Fox, P. J. *In-Situ Load Testing of Corrugated Steel Pipe-Arch Culverts*. Journal of Performance of Constructed Facilities, American Society of Civil Engineers, Vol. 22, No. 4, pp. 245–252, 2008.
215. *How to Submit a Permit Application Over the Internet*. Texas Department of Transportation, Motor Carrier Division, Austin, Texas, undated. http://ftp.dot.state.tx.us/pub/txdot-info/mcd/pdf/cps_instr_121008.pdf. Accessed August 31, 2011.
216. *Texas Permitting and Routing Optimization System Online Customer Interface – User Guide*. Draft. Texas Department of Transportation, Motor Carrier Division, Austin, Texas, undated. http://ftp.dot.state.tx.us/pub/txdot-info/mcd/txpros/user_guide.pdf. Accessed August 31, 2011.
217. *Motor Carrier Handbook– Oversize/Overweight Vehicles and Loads*. Texas Department of Transportation, Motor Carrier Division, Austin, Texas, May 2011. http://ftp.dot.state.tx.us/pub/txdot-info/library/pubs/bus/mcd/handbook_osow.pdf. Accessed August 31, 2011.
218. *ROW Utility Manual*. Texas Department of Transportation, Right of Way Division, Austin, Texas, February 2011. <http://onlinemanuals.txdot.gov/txdotmanuals/utl/index.htm>. Accessed August 31, 2011.
219. *43 TAC Section 21.40(f)(1)(A)*. Texas Administrative Code, Title 43, Transportation, Part 1, Texas Department of Transportation, Chapter 21, Right of way, Subchapter C. Obtained from [http://info.sos.state.tx.us/pls/pub/readtac\\$ext.ViewTAC?tac_view=5&ti=43&pt=1&ch=21&sch=C&rl=Y](http://info.sos.state.tx.us/pls/pub/readtac$ext.ViewTAC?tac_view=5&ti=43&pt=1&ch=21&sch=C&rl=Y). Accessed August 31, 2011.
220. *43 TAC Section 21.40(f)(1)(B)*. Texas Administrative Code, Title 43, Transportation, Part 1, Texas Department of Transportation, Chapter 21, Right of way, Subchapter C. Obtained from [http://info.sos.state.tx.us/pls/pub/readtac\\$ext.ViewTAC?tac_view=5&ti=43&pt=1&ch=21&sch=C&rl=Y](http://info.sos.state.tx.us/pls/pub/readtac$ext.ViewTAC?tac_view=5&ti=43&pt=1&ch=21&sch=C&rl=Y). Accessed August 31, 2011.
221. *43 TAC Section 21.40(c)(3)*. Texas Administrative Code, Title 43, Transportation, Part 1, Texas Department of Transportation, Chapter 21, Right of way, Subchapter C. Obtained from [http://info.sos.state.tx.us/pls/pub/readtac\\$ext.ViewTAC?tac_view=5&ti=43&pt=1&ch=21&sch=C&rl=Y](http://info.sos.state.tx.us/pls/pub/readtac$ext.ViewTAC?tac_view=5&ti=43&pt=1&ch=21&sch=C&rl=Y). Accessed August 31, 2011.

222. *43 TAC Section 21.40(e)(3)*. Texas Administrative Code, Title 43, Transportation, Part 1, Texas Department of Transportation, Chapter 21, Right of way, Subchapter C. Obtained from [http://info.sos.state.tx.us/pls/pub/readtac\\$ext.ViewTAC?tac_view=5&ti=43&pt=1&ch=21&sch=C&rl=Y](http://info.sos.state.tx.us/pls/pub/readtac$ext.ViewTAC?tac_view=5&ti=43&pt=1&ch=21&sch=C&rl=Y). Accessed August 31, 2011.
223. *43 TAC Section 21.40(f)(2)(B)(iii)*. Texas Administrative Code, Title 43, Transportation, Part 1, Texas Department of Transportation, Chapter 21, Right of way, Subchapter C. Obtained from [http://info.sos.state.tx.us/pls/pub/readtac\\$ext.ViewTAC?tac_view=5&ti=43&pt=1&ch=21&sch=C&rl=Y](http://info.sos.state.tx.us/pls/pub/readtac$ext.ViewTAC?tac_view=5&ti=43&pt=1&ch=21&sch=C&rl=Y). Accessed August 31, 2011.

APPENDIX A. COMPARISON OF INSTALLATION SPECIFICATIONS FOR BURIED UTILITY FACILITIES IN THE 1979 AND 2010 UTILITY ACCOMMODATION RULES

Table 68. General Rules for Underground Utilities.

| Topic | 1979 UAR | 2010 UAR |
|------------|---|--|
| Encasement | <ul style="list-style-type: none"> • In general, underground utility line crossings shall be encased. • Encasement shall be as specified for each type of line and shall be composed of materials of satisfactory durability. • The strength of the encasement material shall equal or exceed structural requirements for drainage culverts. • Welded steel pipeline crossings may be without encasement if such pipelines conform to 49CFR 192 or 49CFR195 and provide increased wall thickness and/or higher strength steel, greater depth of cover, and adequate markings. | <ul style="list-style-type: none"> • Utilities crossing a highway shall be encased by steel, concrete, or plastic pipes. • If horizontal directional drilling is used to place the casing, high-density polyethylene (HDPE) pipe must be used in place of plastic pipe. • The strength of the encasement material shall equal or exceed structural requirements for drainage culverts. • The length of any encasement under the roadway shall be provided from top of backslope to top of backslope for cut sections, 5 ft beyond the toe of slope for fill sections, or 5 ft beyond the face of the curb for curb sections. |
| Depth | <ul style="list-style-type: none"> • The department shall specify other protection in lieu of the depth required for the particular utility line where placements at the required depths are impractical. | <p>Additional protection is needed where placements at the required depths are impractical, including encasement or use of a reinforced concrete slab. Reinforced concrete slabs or caps shall meet the following standards:</p> <ul style="list-style-type: none"> • Width: 5 ft, or three times the diameter of the pipe, whichever is greater. • Thickness: 6 in., at minimum. • Reinforcement: #4 bars at 12 in. centers each way or equivalent reinforcement. • Cover: no less than 6 in. of sand or equivalent cushion between the bottom of the slab/cap and the top of the pipe. |
| Manholes | <ul style="list-style-type: none"> • Manholes should be straight on line installations with a minimum overall width necessary to operate and maintain the enclosed equipment. | <ul style="list-style-type: none"> • A manhole's dimensions shall be the minimum acceptable by appropriate engineering and safety standards. • Inline manholes are the only type permitted within the right of way. • The width dimensions shall be no larger than necessary to hold equipment involved and to meet safety standards for maintenance personnel. Outside width, the dimension of the manhole perpendicular to the highway, shall not exceed 10 ft. |

Table 68. General Rules for Underground Utilities (Continued).

| Topic | 1979 UAR | 2010 UAR |
|-------------------------|---|--|
| Manholes (Continued) | | <ul style="list-style-type: none"> • The outside diameter of the manhole chimney at the ground level shall not exceed 36 in. The district may allow an outside diameter of up to 50 in. • The top of the roof of the manhole shall be 5 ft or more below ground level. • Manhole rings and covers must be designed for HS-20 loading. |
| Installation | <ul style="list-style-type: none"> • Lines beneath an existing highway shall be installed by boring or tunneling. Jacking may not be used unless approved by the district. Bore pits should be located: <ul style="list-style-type: none"> ○ At least 30 ft from the edge of the nearest through traffic lane and no less than 20 ft from the edge of pavement on ramps. ○ Not less than 10 ft from the edge of pavement or 5 ft from face of curb for low traffic roadways and frontage roads. ○ If the above requirement cannot be met, additional approved protective devices will be installed for protection of the traveling public. • The use of explosives needs to be permitted by the department. • Where longitudinal trenching is permitted, backfill shall be compacted to densities equal to that of the surrounding soil. Trenching across jointed concrete pavement is not allowed and in no instance shall trenching across continuously reinforced concrete pavement be permitted. | <ul style="list-style-type: none"> • Lines beneath an existing highway shall be installed by boring or tunneling. Jacking may not be used unless approved in writing by the district. The use of explosives is prohibited. Pipe bursting or fluid/mist jetting may be allowed by the department. • For rural, uncurbed highway crossings, all borings shall extend beneath all travel lanes with the following clearances unless precluded by right of way limitations: <ul style="list-style-type: none"> ○ 30 ft from all freeway mainlanes and other high-speed (>40 mph) highways. ○ 16 ft for high-speed highways with current average daily traffic volumes of 750 vehicles per day or fewer. ○ 16 ft for ramps. ○ 10 ft for low-speed (40 mph or less) highways. • Annular voids greater than 1 in. between the borehole and carrier line (or casing if used) shall be filled with a slurry grout or other flowable fill. • For curbed highway crossings, all borings shall extend beneath travel and parking lanes and extend beyond the back of curb, plus: <ul style="list-style-type: none"> ○ 30 ft from facilities with speed limits of 40 mph or greater. ○ 5 ft from facilities with speed limits of 40 mph or less, plus any additional width necessary to clear an existing sidewalk. • When trenching longitudinally, backfill or stabilized sand shall be compacted to densities equal to that of the surrounding soil. |

Table 68. General Rules for Underground Utilities (Continued).

| Topic | 1979 UAR | 2010 UAR |
|---|--|--|
| Unsuitable conditions for underground utilities | <p>Conditions not suitable for pipeline crossings:</p> <ul style="list-style-type: none"> • Deep cuts. • Locations near footings or bridges and retaining walls. • Crossing intersections at-grade or ramp terminals. • At cross-drains where flow of water, drift, or stream bedload may be obstructed. • Locations within basins or underpasses drained by pump if the pipeline carries a liquid or liquefied gas. • Wet or rocky terrain where minimum depth of cover would be difficult to attain. | <p>Conditions unsuitable or undesirable for pipeline crossings:</p> <ul style="list-style-type: none"> • Deep cuts. • Locations near footings or bridges and retaining walls. • Crossing intersections at-grade or ramp terminals. • Locations at cross-drains where the flow of water may be obstructed. • Locations within basins or underpasses drained by pump if the pipeline carries a liquid or liquefied gas. • Terrain where minimum depth of cover would be difficult to attain. |
| Clearances | <ul style="list-style-type: none"> • Vertical and horizontal clearances between a pipeline and a structure or other highway or utility facilities should be sufficient to permit maintenance of the pipeline and the other facilities. | <ul style="list-style-type: none"> • Except as specified in this subchapter, there shall be a minimum of 12 in. vertical and horizontal clearance between a pipeline and an existing utility. • If an installation of another utility or highway feature cannot take place without disturbing an existing utility, the minimum clearance will be 24 in. |

Table 69. Low Pressure Gas and Liquid Petroleum Lines.

| Topic | 1979 UAR | 2010 UAR |
|----------------|---|---|
| Depth of cover | <ul style="list-style-type: none"> • The minimum depth of cover within the right of way and under highway ditches, but outside the pavement structure, shall be 24 in. for either encased or unencased installations. A reduction of 6 in. in the above requirements may be authorized to permit existing lines to remain in place. • Lines shall be a minimum of 18 in. or 1/2 the diameter of the pipe, whichever is greater, beneath the bottom of the pavement structure. Where materials and other conditions justify, a minimum depth under the pavement structure of 12 in. or 1/2 the diameter of the pipe, whichever is greater, may be permitted. | <p>For crossings:</p> <ul style="list-style-type: none"> • Where materials and other conditions justify, the district may require a minimum depth of cover under the pavement structure of 12 in. or 1/2 the diameter of the pipe, whichever is greater. • The minimum depth of cover for encased low-pressure gas lines: <ul style="list-style-type: none"> ○ 18 in. or 1/2 the diameter of the pipe, whichever is greater, under pavement structure. ○ 24 in. outside pavement structure and under ditches (original unsilted flow line). ○ 30 in. for unencased sections of encased lines outside of pavement structure. • The minimum depth of cover for unencased low-pressure gas lines: <ul style="list-style-type: none"> ○ 60 in. under the pavement surface or 18 in. under the pavement structure for paved areas. ○ 48 in. outside paved areas and under ditches (original unsilted flow line). ○ A lesser depth if authorized by the district where a reinforced concrete slab is used to protect the pipeline. <p>For longitudinal installations:</p> <ul style="list-style-type: none"> • The minimum depth of cover shall be 36 in. |
| Encasement | <ul style="list-style-type: none"> • Lines shall be encased as required for high pressure gas and liquid petroleum lines or they may be placed without encasement if they are of welded steel construction and are protected from corrosion by adequate and approved cathodic protective measure, with specific agreement that the pavement will not be cut for repairs at any time in the future. | <ul style="list-style-type: none"> • Crossings shall be placed in a steel encasement, unless the line is of welded steel construction and is protected from corrosion. |
| Plastic lines | <ul style="list-style-type: none"> • Plastic lines may be used provided the internal pressure will not exceed 60 lb per square in., but shall be encased right of way line to right of way line on crossings and have at least 30 in. of cover. • The maximum size of plastic lines shall not exceed 6 in. • Longitudinal plastic lines shall be installed concurrently with a durable metal wire or other means for detection purposes. | <ul style="list-style-type: none"> • Plastic lines shall be encased within the right of way on crossings, and must have at least 30 in. of cover. |

Table 69. Low Pressure Gas and Liquid Petroleum Lines (Continued).

| Topic | 1979 UAR | 2010 UAR |
|-------------------------------------|--|---|
| Exceptions to location requirements | <ul style="list-style-type: none"> • In urban areas, existing longitudinal lines that can be maintained without violating access control and that are not under the pavement or shoulder of any proposed roadway or existing roadway that is scheduled for a major improvement may remain in place. | <ul style="list-style-type: none"> • n/a |

Table 70. High Pressure Gas and Liquid Petroleum Lines.

| Topic | 1979 UAR | 2010 UAR |
|----------------|--|---|
| Depth of cover | <p>For encased lines:</p> <ul style="list-style-type: none"> • The minimum total clear depth of cover for casing pipe shall be 30 in. For the portion of the carrier line outside of the casing pipe the minimum depth of cover within right of way shall be 36 in. Exceptions may be authorized to permit existing lines to remain in place with a reduction of 6 in. in the above-specified depths. • All lines normally shall be a minimum of 18 in. or 1/2 the diameter of the pipe, whichever is greater, beneath the bottom of the pavement structure. Where materials and other conditions justify, a minimum depth under the pavement structure of 12 in. or 1/2 the diameter of the pipe, whichever is greater, may be permitted. <p>For unencased lines:</p> <ul style="list-style-type: none"> • The minimum depth of cover shall be 60 in. under the pavement surface or 18 in. under the pavement structure, whichever is greater. Under ditches, the minimum depth of cover shall be 48 in. • A reduction in the specified depths may be authorized where the pipeline is protected by a reinforced concrete slab. | <p>For crossings:</p> <ul style="list-style-type: none"> • Encased lines. Where materials and other conditions justify, the district may approve a minimum depth of cover under the pavement structure of 12 in. or 1/2 the diameter of the pipe, whichever is greater. Otherwise, the minimum depth of cover shall be: <ul style="list-style-type: none"> ○ The greater of 18 in. or 1/2 the diameter of the pipe, under pavement structures. ○ 30 in. if the line is outside the pavement structure or under a ditch. ○ 36 in. for unencased sections of encased lines outside the pavement structure. • Unencased lines. Where a reinforced concrete slab is used to protect the pipeline, the district may authorize a reduction in the depths. Otherwise, the minimum depth of cover is as follows: <ul style="list-style-type: none"> ○ 60 in. under the pavement surface or 18 in. under the pavement structure in paved areas. ○ 48 in. if the line is placed outside the pavement structure or under a ditch. <p>For longitudinal installations:</p> <ul style="list-style-type: none"> • The minimum depth of cover shall be 48 in. |
| Encasement | <p>Encasement for crossings:</p> <ul style="list-style-type: none"> • Pipelines across highways may be encased or unencased. • When encasement is used, such encasement shall be provided under center medians and from top of backslope to top of backslope for cut sections or 5 ft beyond the toe of slope for fill sections, or face of curve, of all roadways, and 5 ft beyond any overpass or other structure where the line passes under it. • Where encasement is not employed, the welded steel carrier pipe shall provide sufficient strength to withstand the internal design pressure and the dead and live loads of the pavement structure and traffic. Additional protections should include: | <ul style="list-style-type: none"> • Casing shall consist of a vented steel pipe. • Where encasement is not employed, the utility shall show that the welded steel carrier pipe will provide sufficient strength. Additional protective measures must include: <ul style="list-style-type: none"> ○ Heavier wall thickness, higher factor of safety in design, or both. ○ Adequate coating and wrapping. ○ Cathodic protection. ○ The use of Barlow's formula regarding maximum allowable operating pressure and wall thickness, as specified in 49CFR §192.105. |

Table 70. High Pressure Gas and Liquid Petroleum Lines (Continued).

| Topic | 1979 UAR | 2010 UAR |
|-------------------------------------|---|--|
| Encasement (Continued) | <ul style="list-style-type: none"> ○ Heavier all thickness and/or higher factor of safety in design. ○ Adequate coating and wrapping. ○ Cathodic protection. ○ Other measures as required by 49CFR192 or 49CFR195. ● The minimum length of the above additional protection shall be the same as that required by encasement. ● Existing lines under low volume roads may be permitted to remain in place without encasement or extension of encasement if they are protected by a reinforced concrete slab or equivalent protection or if they are located at a depth of 6 ft under the pavement surface and not less than 4 ft under the roadway ditch. Reinforced concrete slabs should meet the following standards: <ul style="list-style-type: none"> ○ Width: three times the diameter of the pipe or 5 ft minimum, whichever is greater. ○ Thickness: 6-in. minimum. ○ Reinforcement: #4 bars @ 12 in. centers each way or equivalent wire mesh. ● Cover: the cushion between the bottom of slab and top of pipe shall be not less than 6 in. | <ul style="list-style-type: none"> ● Shallow anode bed types exceeding 48 in. in width shall not be permitted in right of way. All others must have a depth of coverage of at least 36 in. Deep well anode beds of up to 60 in. in diameter are acceptable. Rectifier and meter loop poles shall be placed at or near the right of way line. ● The minimum length of the additional protection shall be the same as that required for an encased crossing. ● The district may allow existing lines under low-volume highways to remain in place without encasement or extension of encasement if they are protected by a reinforced concrete slab or equivalent protection or if they are located at a depth of 5 ft under the pavement structure and not less than 4 ft under a highway ditch. |
| Exceptions to location requirements | <ul style="list-style-type: none"> ● In urban areas, existing longitudinal lines that are not under the pavement or shoulder of any roadway or in the center median of a controlled access highway may be permitted to remain in place. | <ul style="list-style-type: none"> ● n/a |

Table 71. Water Lines and Non-Potable Water Control Facilities.

| Topic | 1979 UAR | 2010 UAR |
|-------------------------------------|--|---|
| Water Lines | | |
| Depth of cover | <ul style="list-style-type: none"> The same as required for low pressure gas lines. | <ul style="list-style-type: none"> The minimum depth of cover shall be 30 in., but not less than 18 in. below the pavement structure for crossings. |
| Encasement | <ul style="list-style-type: none"> Encasement shall be provided under normal width center medians and from center of ditch to center of ditch for cut sections or 5 ft behind toe of slope for fill sections or face of curb of all roadways. Encasement may be omitted under center medians where their width is appreciably greater than normal rural standards. Encasement under side road entrances may be omitted if conditions allow. Encasement under low traffic roadways may be omitted on existing water lines having an inside diameter of 24 in. or more and on new lines having an inside diameter of 30 in. or more when all other requirements are met. | <ul style="list-style-type: none"> Unless otherwise approved, water lines crossing under paved highways must be placed in a steel encasement pipe within the limits of right of way. Encasement may be omitted under center medians and outer separations that are more than 76 ft wide. Encasement under side road entrances may be omitted in consideration of traffic volume, condition of highway, maintenance responsibility, or district practice. Existing water lines 24 in. or greater may be allowed to remain unencased under the pavement of new low volume highways. |
| Lines crossing highway by bore | <ul style="list-style-type: none"> n/a | <ul style="list-style-type: none"> Lines for customer service that cross the highway may be placed in an HDPE encasement pipe without joints (rolled pipe). |
| Plastic lines | <ul style="list-style-type: none"> Plastic lines may be used when they have at least 30 in. of cover for both crossing and longitudinal segments. Crossings shall be encased in accordance with §21.42 (Pipelines – General) and §21.43 (High Pressure Gas and Liquid Petroleum Lines). | <ul style="list-style-type: none"> n/a |
| Manholes | <ul style="list-style-type: none"> The outside diameter of the manhole chimney at the ground level shall not exceed 36 in. | <ul style="list-style-type: none"> n/a |
| Exceptions to location requirements | <ul style="list-style-type: none"> Same as required for low pressure gas lines. | <ul style="list-style-type: none"> n/a |
| Irrigation and drainage facilities | <ul style="list-style-type: none"> Irrigation and drainage facilities installed across right of way shall be designed and constructed in accordance with departmental standards for highway culverts or bridges. | <ul style="list-style-type: none"> n/a |

Table 71. Water Lines and Non-Potable Water Control Facilities (Continued).

| Topic | 1979 UAR | 2010 UAR |
|---|---|--|
| Non-Potable Water Control Facilities | | |
| Depth of cover for buried pipe facilities | <ul style="list-style-type: none"> • n/a | <ul style="list-style-type: none"> • The minimum depth of cover shall be 30 in., but not less than 18 in. below any pavement structure. |
| Encasement for buried pipe facilities | <ul style="list-style-type: none"> • n/a | <ul style="list-style-type: none"> • Unless the district approves another type of encasement, all non-potable water control lines crossing under paved highways within right of way must be placed in a steel encasement pipe. • At the district’s discretion, encasement may be omitted under center medians and outer separations that are more than 76 ft wide. |

Table 72. Installation Specifications for Buried Utility Facilities – Sanitary Sewer Lines.

| Topic | 1979 UAR | 2010 UAR |
|---|---|--|
| Depth of cover | <ul style="list-style-type: none"> The same as required for low pressure gas lines. | <ul style="list-style-type: none"> The minimum depth of cover shall be 30 in., but not less than 18 in. below any pavement structure. |
| Encasement | <ul style="list-style-type: none"> Lines to be operated under pressure and those composed of materials not conforming to material or depth of cover requirements shall be encased as prescribed for water lines. | <ul style="list-style-type: none"> Pressurized line crossings under paved highways within the limits of the right of way shall be placed in a steel encasement pipe. Gravity flow lines not conforming to the minimum depth of cover shall be encased in steel or concrete. At the district’s discretion, encasement may be omitted under center medians and outer separations that are more than 76 ft wide. |
| Materials | <ul style="list-style-type: none"> Sewer line crossings shall be cast iron, with satisfactory joints, or materials and designs that will provide equal strength and resistance to damage from sulfide gases and other corrosive elements. Concrete pipes may be used in those areas where its use has been proven acceptable. New and relocated longitudinal lines and those crossing low traffic roadways may be of any material that has been proven to be of satisfactory strength and durability, provided all other requirements are met. | <ul style="list-style-type: none"> n/a |
| Manholes | <ul style="list-style-type: none"> Manholes serving sewer lines up to 12 in. shall have a maximum inside diameter of 4 ft. For any increase in line size greater than 12 in., the manhole diameter may be increased a like amount. Manholes for large interceptor sewers should be specially designed, keeping the overall dimensions to a minimum. The outside diameter of the manhole chimney at the ground level shall not exceed 3ft. | <ul style="list-style-type: none"> n/a |
| Exception for existing lines in urban areas | <ul style="list-style-type: none"> The department may approve existing sewer lines in urban areas to remain in place at some locations. | <ul style="list-style-type: none"> n/a |

Table 73. Underground Electric Lines.

| Topic | 1979 UAR | 2010 UAR |
|----------------|--|---|
| Depth of cover | <ul style="list-style-type: none"> • The same as required for encased high-pressure gas and liquid petroleum lines. | <p>All lines may be installed by direct bury at the following minimum depth of cover according to the voltage of electric lines as required by the National Electrical Safety Code:</p> <ul style="list-style-type: none"> • 30 in. for electric lines with voltage of 22,000 or less. • 36 in. for electric lines with voltage from 22,001 to 40,000. • 42 in. for electric lines with voltage of 40,001 or greater. |
| Encasement | <ul style="list-style-type: none"> • Encasement shall be provided under center medians and from top of backslope to top of backslope for cut sections or 5 ft beyond the toe of slope for fill sections, or face of curb, of all roadways and 5 ft beyond any overpass or other structure where the line passes under it. • Encasement may be omitted under center medians where their width is appreciably greater than normal rural standards. Existing lines under low-volume roadways may be permitted to remain in place without encasement or extension of encasement if they are protected by a reinforced concrete slab or equivalent protection or if they are located at a depth of 6 ft under the pavement surface and not less than 4 ft under the roadway ditch. Reinforced concrete slabs should meet the following standards: <ul style="list-style-type: none"> ○ Width: 5-ft minimum. ○ Thickness: 6-in. minimum. ○ Reinforcement: #4 bars @ 12 in. centers each way or equivalent wire mesh. ○ Cover: the cushion between the bottom of slab and top of pipe shall be not less than 6 in. | <p>Electric lines crossing the roadway shall be:</p> <ul style="list-style-type: none"> • encased in steel or comparable material greater than or equal to that of ductile iron, with satisfactory joints, or materials and designs that will provide equal or better protection of the integrity of the highway system and resistance to damage from corrosive elements to which they may be exposed; and • buried a minimum of 36 in. under highway ditches, and 60 in. below the pavement structure. |
| Manholes | <ul style="list-style-type: none"> • Straight-line manholes are the only type normally permitted. Overall width dimensions should be no larger than necessary to hold the equipment and for safety standards to be assured. • Outside width should not exceed 7 ft, length should be held to be reasonable minimum and the top of the roof should be 5 ft below ground level. • The outside diameter of the manhole chimney at the ground level should not exceed 36 in. | n/a |

Table 74. Underground Communication Lines.

| Topic | 1979 UAR | 2010 UAR |
|---|--|--|
| Depth of cover for crossings | <ul style="list-style-type: none"> • The minimum depth of cover shall be 24 in. for either encased or unencased installations outside the pavement structure and 18 in. under pavement structure. Where materials and other conditions justify, exceptions may be authorized to permit existing lines to remain in place with a reduction of 6 in. in the above-specified depths. • Crossings should be located at approximate right angles to the highway to the extent feasible and practicable. | <ul style="list-style-type: none"> • The minimum depth of cover for cable television and copper cable communication lines shall be 24 in. under ditches or 18 in. beneath the bottom of the pavement structure, whichever is greater. • The top of the fiber optic facility shall be placed a minimum of 42 in. below the ditch grade or 18 in. below the pavement structure or 60 in. below the top of the pavement surface, whichever is greater. The department may authorize a minimum depth of cover of not less than 36 in. below the ditch grade or 60 in. below the top of the pavement surface, whichever is greater. |
| Depth of cover for longitudinal placement | <ul style="list-style-type: none"> • The minimum depth of cover shall be 24 in. for either encased or unencased installations outside the pavement structure and 18 in. under pavement structure. Where materials and other conditions justify, exceptions may be authorized to permit existing lines to remain in place with a reduction of 6 in. in the above-specified depths. | <ul style="list-style-type: none"> • The minimum depth of cover for cable television and copper cable communications lines shall be 24 in. • The minimum depth of cover for fiber-optic facilities shall be 42 in. The minimum depth of cover may be reduced to not less than 36 in. upon approval. |
| Encasement for crossings | <ul style="list-style-type: none"> • Lines crossing highway do not require encasement except where in the judgment of the district engineer it is necessary. Encasement or other suitable protection should be considered for facilities: <ul style="list-style-type: none"> ○ With less than minimum bury. ○ Near footings of bridges or other highway structures. ○ Near other locations where there may be hazards. • If the installation of the line is to be accomplished by boring a hole the same or about the same diameter as the line and pulling it through, then encasement is not necessary. Where such conditions cannot be met, encasement should be provided. The annular void between the drilled hole and the line or casing should be filled with a satisfactory material to prevent settlement of any part of the highway facility over the line or casing. • Encasement may be metallic or nonmetallic material. The strength of the encasement shall equal or exceed structural requirements for drainage culverts. | <p>The department may require encasement or other suitable protection when necessary to protect the highway facility when the line is located:</p> <ul style="list-style-type: none"> • At less than the minimum depth. • Near the footing of a bridge or other highway structure. • Near another hazardous location. |

Table 74. Underground Communication Lines (Continued).

| Topic | 1979 UAR | 2010 UAR |
|---|--|---|
| Encasement for crossings (Continued) | <ul style="list-style-type: none"> • The length of any encasement shall be under center medians and from top of backslope to of backslope for cut sections or 5 ft beyond the toe of slope for fill sections, or face of curb, of all roadways. • Encasement may be omitted under center medians where their width is appreciably greater than normal rural standards. Where encasement is not installed, specific agreement should be reached with the utility company that the pavement will not be cut for repairs any time in the future. | |
| Manholes | <ul style="list-style-type: none"> • Straight-line manholes are the only type normally permitted. • Manholes should not be installed in the pavement or shoulders of high volume roads except at locations on non-controlled access highways in urban areas where necessary for existing lines. • Manholes may remain in place or be installed under traffic lanes of low volume roadways in municipalities provided measures are taken to minimize such installations and to avoid their locations at intersections insofar as possible. • Manhole dimensions should be the minimum acceptable for good engineering and safety standards. Outside width should not exceed 7 ft, with the length to be held to a minimum. • The outside diameter of the manhole chimney at the ground level should not exceed 36 in. or 50 in. when proven necessary. • The top of the roof of the manhole should be 5 ft below ground level. Where such depth cannot be met, sufficient data should be submitted to the department for administrative handling. | <ul style="list-style-type: none"> • n/a |

APPENDIX B. ANALYSIS OF OVERWEIGHT LOADS ON TXDOT HIGHWAY SYSTEM

INTRODUCTION

The TxDOT Motor Carrier Division (MCD) provided the research team with six fiscal years (2004–2009) of overweight load permit history for analysis and reporting purposes. The raw data were in the format of dBase V databases tables. Table 75 shows the number of records available for each year, the percent increase of overweight load permits from one year to the next, and the total number of records available to the research team. The raw dataset includes about half a million overweight load permits annually. From 2004 to 2009, the increase in processed permits was more than 19 percent, equivalent to an average annual increase of about 3.8 percent per year. From 2008 to 2009 the number of processed permits decreased by about 9 percent.

Table 75. Total Overweight Load Permits.

| Fiscal Year | Number of Permits | Percent Increase |
|--------------------|--------------------------|-------------------------|
| 2004 | 445,081 | |
| 2005 | 482,230 | 8.3% |
| 2006 | 523,474 | 8.6% |
| 2007 | 556,338 | 6.3% |
| 2008 | 582,583 | 4.7% |
| 2009 | 529,900 | -9.0% |
| Total | 3,119,606 | |

The goal of the data processing was to analyze the route descriptions and convert the available text information into route segments that could then be converted to route features in a GIS. The outcome of the process would be a geodatabase that would contain route features of permitted overweight truck movements for fiscal years 2004 through 2009. The geodatabase could then be used for example to display permitted overweight routes on a map of Texas highways.

OVERWEIGHT ROUTE DATA PROCESSING

Initial Data Analysis

The first step of the initial data analysis was to import the route information into a Microsoft Access 2007 database in order to perform a review of the data structure. The OS/OW load permits database consists of 128 fields in one table that is not normalized. Table 76 provides an overview of the fields of the OS/OW load permits database table along with field type, field, size, and field description, and thus provides the complete data structure of the overweight load route permit data provided by TxDOT.

Table 76. Structure of Overweight Load Route Permits Database Table.

| Field Name | Field Description | Type | Size |
|--------------------|---|-------------|------------|
| PERMIT_NBR | TxDOT Assigned Permit Number | Text | 12 |
| PERMIT_TYP | TxDOT Assigned Permit Type | Text | 50 |
| TRUCK_YR | Year of Semi Truck's Manufacture | Text | 4 |
| TRUCK_MAKE | Manufacturer of Semi Truck | Text | 30 |
| LOAD_DESC | Permit Load Description | Text | 50 |
| WIDTH_FT | Semi Truck Width in Feet | Double | 8 |
| WIDTH_IN | Semi Truck Width in Inches | Double | 8 |
| LEGAL_WIDT | Semi Truck Legal Width | Text | 1 |
| HEIGHT_FT | Semi Truck Height in Feet | Double | 8 |
| HEIGHT_IN | Semi Truck Height in Inches | Double | 8 |
| LEGAL_HEIG | Semi Truck Legal Height | Text | 1 |
| LENGTH_FT | Semi Truck Length in Feet | Double | 8 |
| LENGTH_IN | Semi Truck Length in Inches | Double | 8 |
| LEGAL LENG | Semi Truck Legal Length | Text | 1 |
| FOH_FT | Semi Truck FOH Length in Feet | Double | 8 |
| FOH_IN | Semi Truck FOH Length in Inches | Double | 8 |
| LEGAL_FOH | Semi Truck FOH Legal Length | Text | 1 |
| ROH_FT | Semi Truck ROH Length in Feet | Double | 8 |
| ROH_IN | Semi Truck ROH Length in Inches | Double | 8 |
| LEGAL_ROH | Semi Truck ROH Legal Length | Text | 1 |
| WEIGHT | Semi Truck Weight | Double | 8 |
| WEIGHT_OVE | Semi Truck Weight Over | Text | 1 |
| WEIGHT_RED | Semi Truck Weight Red | Text | 1 |
| LEGAL_WEIG | Semi Truck Legal Weight | Text | 1 |
| ROUTE_START | TxDOT Permit Route Start City Name | Text | 30 |
| ROUTE_END | TxDOT Permit Route End City Name | Text | 30 |
| ROUTE_DESC | TxDOT Permit Route Description | Text | 255 |
| PERMIT_STA | TxDOT Permit Start Date | Date/Time | 8 |
| PERMIT_END | TxDOT Permit End Date | Date/Time | 8 |
| SPACING1 | Semi Truck Spacing 1st Increment | Double | 8 |
| SPACING2 | Semi Truck Spacing 2nd Increment | Double | 8 |
| SPACING3 | Semi Truck Spacing 3rd Increment | Double | 8 |
| SPACING4 | Semi Truck Spacing 4th Increment | Double | 8 |
| SPACING5 | Semi Truck Spacing 5th Increment | Double | 8 |
| SPACING6 | Semi Truck Spacing 6th Increment | Double | 8 |
| SPACING7 | Semi Truck Spacing 7th Increment | Double | 8 |
| SPACING8 | Semi Truck Spacing 8th Increment | Double | 8 |
| SPACING9 | Semi Truck Spacing 9th Increment | Double | 8 |
| SPACING10 | Semi Truck Spacing 10th Increment | Double | 8 |
| SPACING11 | Semi Truck Spacing 11th Increment | Double | 8 |
| SPACING12 | Semi Truck Spacing 12th Increment | Double | 8 |
| SPACING13 | Semi Truck Spacing 13th Increment | Double | 8 |
| SPACING14 | Semi Truck Spacing 14th Increment | Double | 8 |
| SPACING15 | Semi Truck Spacing 15th Increment | Double | 8 |
| SPACING16 | Semi Truck Spacing 16th Increment | Double | 8 |
| SPACING17 | Semi Truck Spacing 17th Increment | Double | 8 |
| SPACING18 | Semi Truck Spacing 18th Increment | Double | 8 |

**Table 77. Structure of Overweight Load Route Permits Database Table
(Continued).**

| Field Name | Field Description | Type | Size |
|-------------------|-----------------------------------|-------------|-------------|
| SPACING19 | Semi Truck Spacing 19th Increment | Double | 8 |
| SPACING20 | Semi Truck Spacing 20th Increment | Double | 8 |
| SPACING21 | Semi Truck Spacing 21st Increment | Double | 8 |
| SPACING22 | Semi Truck Spacing 22nd Increment | Double | 8 |
| SPACING23 | Semi Truck Spacing 23rd Increment | Double | 8 |
| SPACING24 | Semi Truck Spacing 24th Increment | Double | 8 |
| WEIGHT1 | Semi Truck Weight 1st Increment | Double | 8 |
| WEIGHT2 | Semi Truck Weight 2nd Increment | Double | 8 |
| WEIGHT3 | Semi Truck Weight 3rd Increment | Double | 8 |
| WEIGHT4 | Semi Truck Weight 4th Increment | Double | 8 |
| WEIGHT5 | Semi Truck Weight 5th Increment | Double | 8 |
| WEIGHT6 | Semi Truck Weight 6th Increment | Double | 8 |
| WEIGHT7 | Semi Truck Weight 7th Increment | Double | 8 |
| WEIGHT8 | Semi Truck Weight 8th Increment | Double | 8 |
| WEIGHT9 | Semi Truck Weight 9th Increment | Double | 8 |
| WEIGHT10 | Semi Truck Weight 10th Increment | Double | 8 |
| WEIGHT11 | Semi Truck Weight 11th Increment | Double | 8 |
| WEIGHT12 | Semi Truck Weight 12th Increment | Double | 8 |
| WEIGHT13 | Semi Truck Weight 13th Increment | Double | 8 |
| WEIGHT14 | Semi Truck Weight 14th Increment | Double | 8 |
| WEIGHT15 | Semi Truck Weight 15th Increment | Double | 8 |
| WEIGHT16 | Semi Truck Weight 16th Increment | Double | 8 |
| WEIGHT17 | Semi Truck Weight 17th Increment | Double | 8 |
| WEIGHT18 | Semi Truck Weight 18th Increment | Double | 8 |
| WEIGHT19 | Semi Truck Weight 19th Increment | Double | 8 |
| WEIGHT20 | Semi Truck Weight 20th Increment | Double | 8 |
| WEIGHT21 | Semi Truck Weight 21st Increment | Double | 8 |
| WEIGHT22 | Semi Truck Weight 22nd Increment | Double | 8 |
| WEIGHT23 | Semi Truck Weight 23rd Increment | Double | 8 |
| WEIGHT24 | Semi Truck Weight 24th Increment | Double | 8 |
| WEIGHT25 | Semi Truck Weight 25th Increment | Double | 8 |
| TIRES1 | Semi Truck 1st Tire | Double | 8 |
| TIRES2 | Semi Truck 2nd Tire | Double | 8 |
| TIRES3 | Semi Truck 3rd Tire | Double | 8 |
| TIRES4 | Semi Truck 4th Tire | Double | 8 |
| TIRES5 | Semi Truck 5th Tire | Double | 8 |
| TIRES6 | Semi Truck 6th Tire | Double | 8 |
| TIRES7 | Semi Truck 7th Tire | Double | 8 |
| TIRES8 | Semi Truck 8th Tire | Double | 8 |
| TIRES9 | Semi Truck 9th Tire | Double | 8 |
| TIRES10 | Semi Truck 10th Tire | Double | 8 |
| TIRES11 | Semi Truck 11th Tire | Double | 8 |
| TIRES12 | Semi Truck 12th Tire | Double | 8 |
| TIRES13 | Semi Truck 13th Tire | Double | 8 |
| TIRES14 | Semi Truck 14th Tire | Double | 8 |

**Table 77. Structure of Overweight Load Route Permits Database Table
(Continued).**

| Field Name | Field Description | Type | Size |
|------------|----------------------|--------|------|
| TIRES15 | Semi Truck 15th Tire | Double | 8 |
| TIRES16 | Semi Truck 16th Tire | Double | 8 |
| TIRES17 | Semi Truck 17th Tire | Double | 8 |
| TIRES18 | Semi Truck 18th Tire | Double | 8 |
| TIRES19 | Semi Truck 19th Tire | Double | 8 |
| TIRES20 | Semi Truck 20th Tire | Double | 8 |
| TIRES21 | Semi Truck 21st Tire | Double | 8 |
| TIRES22 | Semi Truck 22nd Tire | Double | 8 |
| TIRES23 | Semi Truck 23rd Tire | Double | 8 |
| TIRES24 | Semi Truck 24th Tire | Double | 8 |
| TIRES25 | Semi Truck 25th Tire | Double | 8 |
| SIZE1 | Semi Truck 1st Size | Double | 8 |
| SIZE2 | Semi Truck 2nd Size | Double | 8 |
| SIZE3 | Semi Truck 3rd Size | Double | 8 |
| SIZE4 | Semi Truck 4th Size | Double | 8 |
| SIZE5 | Semi Truck 5th Size | Double | 8 |
| SIZE6 | Semi Truck 6th Size | Double | 8 |
| SIZE7 | Semi Truck 7th Size | Double | 8 |
| SIZE8 | Semi Truck 8th Size | Double | 8 |
| SIZE9 | Semi Truck 9th Size | Double | 8 |
| SIZE10 | Semi Truck 10th Size | Double | 8 |
| SIZE11 | Semi Truck 11th Size | Double | 8 |
| SIZE12 | Semi Truck 12th Size | Double | 8 |
| SIZE13 | Semi Truck 13th Size | Double | 8 |
| SIZE14 | Semi Truck 14th Size | Double | 8 |
| SIZE15 | Semi Truck 15thSize | Double | 8 |
| SIZE16 | Semi Truck 16th Size | Double | 8 |
| SIZE17 | Semi Truck 17thSize | Double | 8 |
| SIZE18 | Semi Truck 18th Size | Double | 8 |
| SIZE19 | Semi Truck 19th Size | Double | 8 |
| SIZE20 | Semi Truck 20th Size | Double | 8 |
| SIZE21 | Semi Truck 21st Size | Double | 8 |
| SIZE22 | Semi Truck 22nd Size | Double | 8 |
| SIZE23 | Semi Truck 23rd Size | Double | 8 |
| SIZE24 | Semi Truck 24th Size | Double | 8 |
| SIZE25 | Semi Truck 25th Size | Double | 8 |

The table's PERMIT_NBR field provides a unique number for each permit in the table. However, the subsequent analysis showed that multiple records in the database may have the same permit number, and thus PERMIT_NBR is not a unique identifier of a record in the database.

The researchers observed that the analysis of overweight load permit route data needed to focus on three data elements, which are highlighted in Table 76 as follows:

- ROUTE_START.
- ROUTE_END.
- ROUTE_DESC.

For the majority of records, the field ROUTE_START provided the starting city of the route, and the field ROUTE_END provided the city in which the route ended. The field ROUTE_DESC provided a description of the specific route between the ROUTE_START and ROUTE_END cities.

The route information provided in the route description field was not immediately ready for use with a GIS for several reasons:

- The syntax used for route starts, route ends, and route descriptions was not standardized and contained spelling errors, blank entries, and unknown entries.
- Abbreviations used for route starts, route ends, and route descriptions were not consistent.
- The route description field contained multi-line records in which only one line corresponded to the route information.
- Some records contained uncommon characters such as “؀” that cluttered the picture and made it more difficult to use the information.

In order to create route features in a GIS, the research team determined that spelling errors and abbreviation variations of Texas cities in the ROUTE_START and ROUTE_END fields had to be resolved using an intensive data cleaning process.

The research team reviewed the data in the fields ROUTE_DESC, ROUTE_START, and ROUTE_END to get a better understanding of the permit data, determine which portion of the dataset would be useful for further processing, and develop an appropriate data cleaning process. Following the review, the research team classified the data into the following categories:

- **ROUTE_START.** The content of this field was one of the following:
 - A city name.
 - An unprintable character, e.g., carriage return/line feed, which was sometimes followed by additional content on the following lines.
 - The abbreviation “TX.”

- Null, which means the field was empty or more specifically, the content of the field was equal to the ASCII code “null” (i.e., a hexadecimal code of ‘00’).
- The wording “TX 006030058C.”
- **ROUTE_END.** The content of this field was one of the following:
 - A city name.
 - An unprintable character, e.g., carriage return/line feed, which was sometimes followed by additional content on the following lines.
 - The abbreviation “TX.”
 - Null, which means the field was empty or more specifically, the content of the field was equal to the ASCII code “null” (i.e., a hexadecimal code of ‘00’).
- **ROUTE_DESC.** The content of this field was one of the following:
 - A route description with “JCT” or related variation. (“JCT” could appear at the beginning of the record or somewhere within the route description.)
 - A route description starting with a descriptor other than “JCT” (e.g., “IH30w”). (“JCT” or a related variation did not appear in this route description).
 - A city name.
 - An unprintable character, e.g., carriage return/line feed, which was sometimes followed by additional content on the following lines.
 - The abbreviation “TX.”
 - Null, which means the field was empty or more specifically, the content of the field was equal to the ASCII code “null” (i.e., a hexadecimal code of ‘00’).
 - The field started with an uncommon delimiter, e.g., “&.”

Approximately 70 percent of the permits contained a route description with “JCT” or related variation that indicated the junction of two highways. A review of these records found several variations of “JCT,” such as “...JCT,” “..JCT,” “.JCT,” “..**JCT,” “**JCT,” and several others. For those routes that contained a variation of the JCT descriptor, it was necessary to standardize the route description using the standard descriptor “JCT.” Some of the “JCT” variations are shown in Figure 75, which provides a sample of permit route descriptions stored in the route description field.

| |
|---|
| <p>⌋ JCT 2 MILES EAST OF SH 326 ON US 90w,SH 326n,US 69s,SH 327e,US 96n,e,FM 2246e,SH 62s,SH 12n,e,SH 87s, to JCT IH 10⌋</p> |
| <p>UNIT # 4034</p> |
| <p>..JCT US287/US380e, IH35n, DENTON: NW.LP288e,s, US380e, IH30e...</p> <p>US380: 20K SINGLE AXLE; 34K TANDEM AXLE</p> <p>ICC#259050</p> |
| <p>...JCT RALPH FAIR RD/ IH10e, FM3351n, FM473w, FM473e, JCT FM1376,... SEVEN SISTERS DRROUTING IS THE SOLE RESPONSIBILITY OF THE APPLICATE ON CITY STREETS & COUNTY RDS</p> |
| <p>JCT.SP50/IH35Wn, IH20e, FT WORTH/EXIT BU287, IH20SFR, US287WFRs, TO 1ST XOVER, US287n, IH20e, US175se, JCT.FM2860...</p> |
| <p>....JCT SHADY GROVE/ W.LP12s, SP408s, IH20e, US67sw, SH174s, SH171se, HILLSBORO- SH81s, IH35.W.FRs PAST FM310, IH35s, @TEMPLE: EXIT @ AVE H, IH35.W.FRs PAST S.LP363, IH35s, (PALMER)FM734se, JCT YAGER,...</p> |
| <p>αα JCT FEDERAL/IH10w, E.IH610n/w, IH45n, HUNTSVILLE***S.SH75n (PRISON EXIT), DROP @ SOUTHWOOD RD (HUNTSVILLE)αP/UP @ IH45 EFRn*** 1st ON-RAMP: IH45n, DETOUR LOW STRUCTURE @ANGUS RD IN ANGUS, IH45N, IH20E, IH635N,W, SH78N, **SH190 NFRw, US75n, US380w, SH</p> |
| <p>**jct Holmes Rd/SH288WFRs, SH288s, * S.BW8FR, x-under @ fm865 to BW8FRw, us90Aw, sp762s/w, fm762s, fm2218sw, us59sw, sh36n, fm1640w, sp529sw, us59sw, sp10n, us90Aw, fm3013s, fm102nw, fm950w, sh71nw, us90Aw, sh97n, us90w, sh304n, sh71w, fm969n, fm1704ne, e</p> |
| <p>"αJCT JUDSON RD/LP1604e/s, IH35n, IH35En, IH20e, IH45n, IH345n, US75n, JCT IH635α" ROUTE APPROVED BY SUSAN/DALLAS DISTRICT**LOAD MAY TRAVEL AT NIGHT TO DESTINATION DURING DALLAS CURFEW HOURS. MUST TRAVEL INSIDE LANE & LOWER LEVEL OF IH35 IN AUSTIN FR</p> |
| <p>*****jct sh329/sh349/s, to jct of south sh290*****</p> |
| <p>*RQ ROUTE* JCT IH20.SFR/SH149s, SH322s, US259s, US79sw, PALESTINE: NE.LP256s&w, US79sw, JCT FM542...</p> |
| <p>..... JCT N. FM 2943 / US60sw, US385n, US87e, US287n, JCT FM 297</p> |
| <p>... IH10w, SH62s, SH87s, JCT FM3322...</p> |
| <p>⌋ JCT FEDERAL/IH10w, E.IH610n/w/s, IH10w, E.LP1604n/w, IH10w, JCT NM LINE⌋ File Code: T\LOUISIANA TRAN\HOU-NM10</p> |

Figure 75. Sample Route Descriptions Starting with a Variation of “JCT.”

The database did not contain all possible combinations of these types of content. The researchers found that depending on the fiscal year, only the following nine combinations for content appeared in the route start, end, and description fields (Table 77).

Table 77. Types of Data Content for the Combination of Route Start, Route End, and Route Description, and Usefulness of the Data for Further Analysis.

| ID | Route Start | Route End | Route Description | Useful for Route Analysis? | Useful for O-D Analysis? |
|-----------|--------------------|------------------|---------------------------------|-----------------------------------|---------------------------------|
| 1 | City name | City name | Route description with "JCT" | Yes | Yes |
| 2 | City name | City name | Route description without "JCT" | Yes | Yes |
| 3 | City name | City name | Null | No | Yes |
| 4 | City name | City name | Carriage return/line feed | Yes | Yes |
| 5 | City name | City name | Uncommon delimiter | No | Yes |
| 6 | Null | Null | Null | No | No |
| 7 | "TX" | "TX" | "TX" | No | No |
| 8 | "TX 006030058C" | City name | City name | No | No |
| 9 | City name | City name | City name | No | Yes |

Table 78 displays the combinations of types of data provided in Table 77 that appear in the dataset of each fiscal year and the total count for each combination. The totals for each year provided a control mechanism that needed to be equal to the total number of records in all categories for each fiscal year. Evidently, the annual totals provided in Table 78 are identical with the annual totals provided in Table 75.

Table 78. Counts of Data Combinations for ROUTE_START, ROUTE_END, and ROUTE_DESC Fields (Fiscal Years 2004–2009).

| FY 2004 | | | |
|--------------------|------------------|---------------------------------|--------------------------|
| Route Start | Route End | Route Description | Number of Permits |
| City name | City name | Route description with "JCT" | 206,709 |
| City name | City name | Route description without "JCT" | 12,765 |
| City name | City name | Null | 85 |
| City name | City name | Carriage Return/Line Feed | 167,552 |
| City name | City name | Uncommon delimiter | 5 |
| Null | Null | Null | 57,965 |
| Total | | | 445,081 |
| FY 2005 | | | |
| Route Start | Route End | Route Description | Number of Permits |
| City name | City name | Route description with "JCT" | 228,792 |
| City name | City name | Route description without "JCT" | 18,842 |
| City name | City name | Null | 171 |
| City name | City name | Carriage Return/Line Feed | 169,457 |
| City name | City name | Uncommon delimiter | 1 |
| Null | Null | Null | 64,967 |
| Total | | | 482,230 |
| FY 2006 | | | |
| Route Start | Route End | Route Description | Number of Permits |
| City name | City name | Route description with "JCT" | 391,277 |
| City name | City name | Route description without "JCT" | 23,977 |
| City name | City name | Null | 33 |
| City name | City name | Carriage Return/Line Feed | 30,689 |
| City name | City name | Uncommon delimiter | 1 |
| Null | Null | Null | 77,497 |
| Total | | | 523,474 |

Table 78. Counts of Data Combinations for ROUTE_START, ROUTE_END, and ROUTE_DESC Fields (Fiscal Years 2004 -2009) (Continued).

| FY 2007 | | | |
|--------------------|------------------|---------------------------------|--------------------------|
| Route Start | Route End | Route Description | Number of Permits |
| City name | City name | Route description with "JCT" | 417,362 |
| City name | City name | Route description without "JCT" | 23,043 |
| City name | City name | Null | 2 |
| City name | City name | Carriage Return/Line Feed | 23,210 |
| City name | City name | Uncommon delimiter | 5 |
| Null | Null | Null | 92,716 |
| Total | | | 556,338 |
| FY 2008 | | | |
| Route Start | Route End | Route Description | Number of Permits |
| City name | City name | Route description with "JCT" | 441,431 |
| City name | City name | Route description without "JCT" | 20,759 |
| City name | City name | Null | 3 |
| City name | City name | Carriage Return/Line Feed | 20,943 |
| City name | City name | Uncommon delimiter | 1 |
| Null | Null | Null | 99,446 |
| Total | | | 582,583 |
| FY 2009 | | | |
| Route Start | Route End | Route Description | Number of Permits |
| City name | City name | Route description with "JCT" | 396,028 |
| City name | City name | Route description without "JCT" | 4,654 |
| City name | City name | Null | 2 |
| City name | City name | Carriage Return/Line Feed | 21,604 |
| City name | City name | Uncommon delimiter | 10 |
| Null | Null | Null | 96,125 |
| TX | TX | TX | 499 |
| TX # 006030058C | City name | City name | 24 |
| City name | City name | City name | 10,954 |
| Total | | | 529,900 |

DATA PROCESSING AND CLEANSING

A result of the initial data analysis was a need for extensive data cleansing in order to develop GIS routes of OS/OW vehicles. The research team found that data entered in the route description field were not selected from a set of valid values and did not follow a defined data standard. This lack of data integrity and standards in the data entry process was the primary reason for the extensive data cleansing process, including the restructuring of several tables before the data could be utilized for processing or recreation of overweight routes.

Given the amount of data and lack of quality control in the dataset, the research team realized it would be an enormous task to parse and process these data. In order to be more efficient in this process, the task of data cleansing and processing was divided and assigned to two separate task forces. Task force one located in College Station focused on the processing and cleaning of the route description field, and task force two located in San Antonio focused on the processing and cleaning of the route start and route end fields.

Route Description Processing

The processing of the route descriptions started with a separation of permits that did contain data in the route description field from those that did not contain any data in the route description field. Table 79 shows the total number of permits, the number of permits that did not contain route information, and the number of permits with route information. These 2.6 million records, or 84 percent of all permit records, were used in the subsequent data cleaning process.

Table 79. Total Permits and Permits with Defined Routes in Route Description Field.

| Fiscal Year | All Permits | Permits without Route Descriptions | Permits with Route Descriptions | Permits with Route Descriptions (% of All) |
|--------------|------------------|------------------------------------|---------------------------------|--|
| 2004 | 445,081 | 57,965 | 387,116 | 87.0% |
| 2005 | 482,230 | 64,967 | 417,263 | 86.5% |
| 2006 | 523,474 | 77,498 | 445,976 | 85.2% |
| 2007 | 556,338 | 92,717 | 463,621 | 83.3% |
| 2008 | 582,583 | 99,447 | 483,136 | 82.9% |
| 2009 | 529,900 | 96,136 | 433,764 | 81.9% |
| Total | 3,119,606 | 488,730 | 2,630,876 | 84.3% |

The College Station task force developed a five-step string parse data cleansing process using Microsoft Excel and Visual Basic for Applications (VBA) to clean the 2.6 million records with route information. The data cleansing process included the following five steps:

- **Step 1: Standardize Route.** Route names are standardized to follow a 2-character-4-digit convention, which is used in the “Route” database. For example, “IH10” becomes

“IH0010” and “Loop 1604” becomes “LP1604.” Results are stored by fiscal year in separate tables (tbl_FY04_STEP1 - tbl_FY09_STEP1) in the “Standardized routes” dataset.

- **Step 2: Separate Multi Line Records.** There are a large number of records with data that spans multiple lines. This step separates each line into individual fields. Results are stored by fiscal year in separate tables (tbl_FY04_STEP2 - tbl_FY09_STEP2) in the “Multiline routes” dataset.
- **Step 3: Identify Valid Route Information.** This step identifies the line of the multi-line records that contains valid route descriptions. Results are stored by fiscal year in separate tables (tbl_FY04_STEP3 - tbl_FY09_STEP3) in the “Valid route information” dataset.
- **Step 4: Remove Unwanted Characters.** This step included the following processes:
 - Replace all occurrences of “`␣`” with a space.
 - Search for “[” and “] ” and replace with “ (” and “) ,” respectively, so brackets can be used to indicate segments in Step 5. This needed to be done manually because sometimes it was desirable to remove the brackets instead of replacing the brackets with parentheses.
 - Search for “ \$ ” and “ ? ” and replace them with spaces so that these symbols can be used to mark the beginning and end of questionable information in Step 5. This needed to be done manually because of some cases where a different character than a space was a more appropriate replacement of “ \$ “ and “ ? .” For example, a portion of an actual route in the database was as follows:

```
IH0035n,W.SL1604s/e?n,IH0010e
```
 - When reviewing this information, it becomes clear that the route originates from IH 35, continues on Loop 1604 going south, then east, then north, and finally east on IH 10. Therefore, the “ ? ” in this example should be replaced with “ _ ” rather than a space.
 - Results are stored by fiscal year in separate tables (tbl_FY04_STEP4 - tbl_FY09_STEP4) in the “Clean characters” dataset.
- **Step 5: Route Data Cleaning.** Implement the route data cleaning logic as follows:
 - Use “[” and “] ” to mark the beginning and end of landmark description, respectively. If the landmark is a junction of two roadways, the second roadway is duplicated and added after the closing bracket. This allows the separation of the information within the bracket from the route without changing the actual Route.

- Use “ ? ” and “ \$ ” to mark the beginning and end of questionable information, respectively.
- Use “ _ ” for direction information.
- Results are stored by fiscal year in separate tables (tbl_FY04_STEP5 - tbl_FY09_STEP5) “clean route descriptions” dataset.

To aid with the understanding of the process, Table 80 provides a listing of datasets that are created by the five-step data cleaning process along with a dataset definition and the process step that produces the dataset.

Table 80. Dataset Definitions during Route Description Data Processing.

| Step | Dataset Name | Dataset Definition |
|------|------------------------------------|--|
| 0 | All permits | The permit records provided by TxDOT. |
| 0 | Permits with route descriptions | The portion of all permits that contains route descriptions. |
| 0 | Permits without route descriptions | The portion of all permits that does not contain route descriptions. |
| 1 | Standardized routes | A portion of “Permits with route descriptions” that contain a route that could be standardized by the process. |
| 2 | Multiline routes | A portion of “Permits with route descriptions” that contain a multi-line route description that could be separated by the process. |
| 3 | Valid route information | A portion of “Permits with route descriptions” that contain valid route information from a multi-line record. |
| 4 | Clean characters | A portion of “Permits with route descriptions” that contain route information that could be cleaned of unwanted characters. |
| 5 | Clean route descriptions | A portion of “Permits with route descriptions” that contain route descriptions that were cleaned by the 5-Step process. |
| 5 | Flagged route descriptions | A portion of “Permits with route descriptions” that contain route descriptions that were flagged by the 5-Step process. |

Route Description Processing Example

The following provides an example of an actual route description and how the data were cleaned and processed using the five-step process. Modifications of the data from one process step to the next are highlighted in light gray. The example begins with the unedited text that the record provided in the route description field (Figure 76).

```
...JCT Everman Parkway/IH35Wn, IH20e, IH45s, N.IH610e?s,  
IH10e, JCT Sheldon Rd..  
  
Not lowboy  
  
AFFIDAVIT STATUS: PWG
```

Figure 76. Unedited Text of Route Description Field.

In Step 1, the text was edited by the process, and the route names were standardized as follows (Figure 77).

```
...JCT Everman Parkway/IH0035Wn, IH0020e, IH0045s,  
N.IH0610e?s, IH0010e, JCT Sheldon Rd..  
  
Not lowboy  
  
AFFIDAVIT STATUS: PWG
```

Figure 77. Route Description Text Edited by Process Step 1.

In Step 2, the process separated the multi-lines into three separate fields (Figure 78).

```
...JCT Everman Parkway/IH0035Wn, IH0020e, IH0045s,  
N.IH0610e?s, IH0010e, JCT Sheldon Rd..  
  
Not lowboy  
  
AFFIDAVIT STATUS: PWG
```

Figure 78. Route Description Text Edited by Process Step 2.

In Step 3, the process identified valid route information in field 1. The research team retained the information in that field, and for the purpose of this project, ignored the information in fields two and three.

```
...JCT Everman Parkway/IH0035Wn, IH0020e, IH0045s,  
N.IH0610e?s, IH0010e, JCT Sheldon Rd...  
  
Not lowboy  
  
AFFIDAVIT STATUS: PWG
```

Figure 79. Route Description Text Edited by Process Step 3.

In Step 4, the researchers manually removed and cleaned up special characters in the descriptions (Figure 80).

```
...JCT Everman Parkway/IH0035Wn, IH0020e, IH0045s,  
N.IH0610e/s, IH0010e, JCT Sheldon Rd...
```

Figure 80. Route Description Text Edited by Process Step 4.

In Step 5, the process standardized the route information and grouped data elements into route segments using the “[“ and “]” symbols. This data cleaning process produced the following cleaned route description (Figure 81).

```
[JCT Everman Parkway/IH0035Wn]IH0035W_n, IH0020_e,  
IH0045_s, N.IH0610_e_s, IH0010_e, [JCT Sheldon Rd]
```

Figure 81. Route Description Text Edited by Process Step 5.

Only a portion of the records with route information produced clean, useable route information at the conclusion of the five-step data cleansing process. More than half of the records were flagged by the process because of one or multiple issues that prevented the data cleaning. The process assigned a flag to each record to indicate a clean route description or problematic route description, as follows:

- **Flag = 0.** These overweight permits contain completely clean route descriptions with no problems that are ready for GIS processing.
- **Flag = 1.** These overweight permits contain route descriptions with at least one problem and require further processing before they can be used in a GIS analysis. Problems could be one of the following:

- Route not identifiable.
- Missing direction.
- Unknown information.
- Unknown route.
- Multi-spur route.

At the end of the route description processing, the research team created two data subsets: Clean routes and routes that contained a problem or error. Table 81 shows the number of records that contain clean versus flagged route descriptions after the five-step data cleansing process. Figure 82 shows the size of the datasets at the conclusion of the data cleansing process.

Table 81. Permits with Clean and Permits with Flagged Route Descriptions after Five-Step Data Cleansing Process.

| Fiscal Year | Permits with Routes | Permits with Clean Route Descriptions | Permits with Flagged Route Descriptions |
|--------------------|----------------------------|--|--|
| 2004 | 387,116 | 188,829 | 198,287 |
| 2005 | 417,263 | 188,993 | 228,270 |
| 2006 | 445,976 | 202,272 | 243,704 |
| 2007 | 463,621 | 191,157 | 272,464 |
| 2008 | 483,136 | 220,369 | 262,767 |
| 2009 | 433,764 | 216,692 | 217,072 |
| Total | 2,630,876 | 1,208,312 | 1,422,564 |

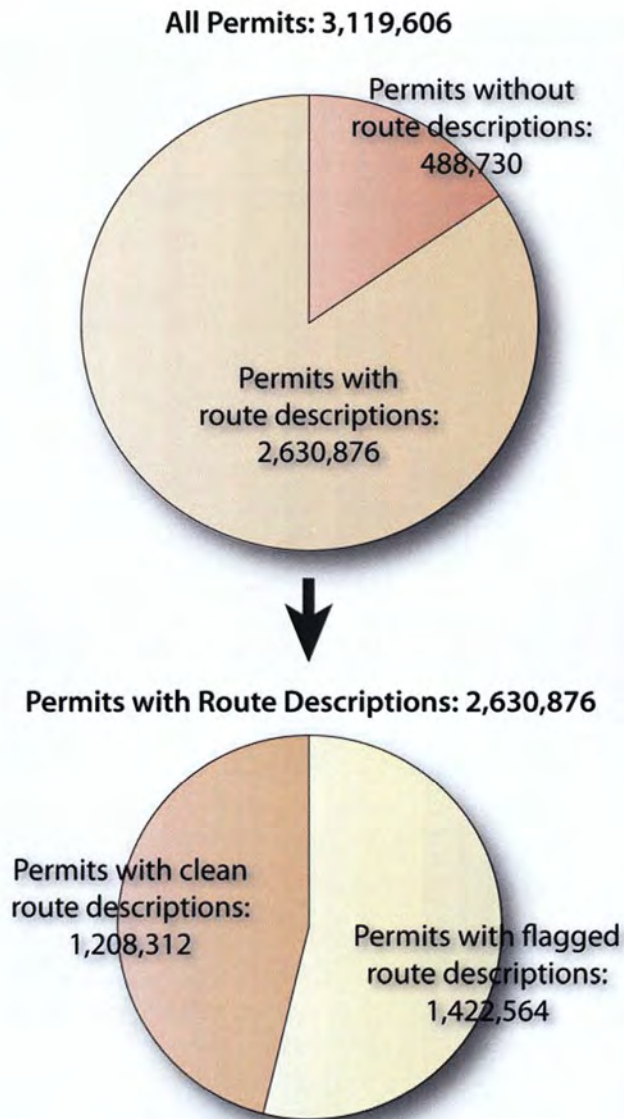

Figure 82. Route Description Data Processing.

The following discussion provides a description of the conditions that resulted in a flag indicating a problem along with an example of a route description that was flagged for that problem.

Route Not Identifiable Issue

A number of permits were flagged because the entry in the route description could not be programmatically identified as a valid route. The following are two examples of route descriptions that were flagged as “no route.”

```
?Jct FM3167/FM0649n- SH0016n- Jct US0059$
```

Figure 83. Route Description with “Route Not Identifiable” Issue, Example 1.

In Figure 83, the operator used a hyphen to separate route information instead of a comma. Since no comma is found, the program cannot positively determine whether this is a valid route description, and thus the record is flagged for “no route.”

?*SEE ATTACHED SHEETS FOR ROUTE AND RESTRICTION INFORMATION*§

Figure 84. Route Description with “Route Not Identifiable” Issue, Example 2.

In Figure 84, the route description field entry is not empty, but it is clearly not a route description. This record is thus also flagged for “no route.” Table 82 provides a count of records that were flagged because of the “no route” condition.

Table 82. Count of Route Descriptions with “Route Not Identifiable” Issue by Year.

| Fiscal Year | Permits with Routes | Routes Not Identifiable | Routes Not Identifiable (%) |
|--------------|---------------------|-------------------------|-----------------------------|
| 2004 | 387,116 | 24,301 | 6.3% |
| 2005 | 417,263 | 28,695 | 6.9% |
| 2006 | 445,976 | 29,218 | 6.6% |
| 2007 | 463,621 | 25,096 | 5.4% |
| 2008 | 483,136 | 31,074 | 6.4% |
| 2009 | 433,764 | 21,864 | 5.0% |
| Total | 2,630,876 | 160,248 | 6.1% |

Missing Direction Issue

A number of permits were flagged because the entry in the route did not provide a valid direction, e.g., n, e, s, w, in the route description. The following is an example of route information that was flagged as “missing direction” (Figure 85).

[JCT WALLISEVILLE
D/E.IH0610s]E.IH0610_s, IH0010_e, E.SL0008_n, US0090_e,
SH0326_n, US0069_n, FM0418_e, [SILSBEE]?BU0096E\$, US0096_n
, FM0363_e, US0190_e

Figure 85. Route Descriptions with “Missing Direction” Issue.

In this case, “BU0096E” is not found in the route database. Since there is no suffix indicating the direction, the record was flagged for “no direction.” Table 83 provides a count of records that were flagged because of the “missing direction” condition.

Table 83. Count of Route Descriptions with “Missing Direction” Issue by Year.

| Fiscal Year | Permits with Routes | Routes with Missing Direction | Routes with Missing Direction (%) |
|--------------------|----------------------------|--------------------------------------|--|
| 2004 | 387,116 | 35,057 | 9.1% |
| 2005 | 417,263 | 43,179 | 10.3% |
| 2006 | 445,976 | 53,415 | 12.0% |
| 2007 | 463,621 | 57,729 | 12.5% |
| 2008 | 483,136 | 45,144 | 9.3% |
| 2009 | 433,764 | 43,250 | 10.0% |
| Total | 2,630,876 | 277,774 | 10.6% |

Unknown Information Issue

Some permits were flagged because the entry in the route description field provided unknown information before the term “JCT” in the route description. The following is an example of route information that was flagged as “unknown information.”

| |
|--|
| <p>[VICTORIA.....3 MILES NORTH OF BU0059ON] US0087_n, US0077_s, US0059_n, W.IH0610_s_e, SH0225_e, SH014 6_n, ?TO THE \$[JCT. SP0330.....BAYTOWN]</p> |
|--|

Figure 86. Route Descriptions with “Unknown Information” Issue.

In this case, “TO THE” is marked as “unknown information before JCT,” and the record was flagged for “unknown information.” Table 84 provides a count of records that were flagged because of the “unknown information” condition.

Table 84. Route Descriptions with “Unknown Information” Issue.

| Fiscal Year | Permits with Routes | Routes with Unknown Information | Routes with Unknown Information (%) |
|--------------|---------------------|---------------------------------|-------------------------------------|
| 2004 | 387,116 | 52,090 | 13.5% |
| 2005 | 417,263 | 74,346 | 17.8% |
| 2006 | 445,976 | 72,212 | 16.2% |
| 2007 | 463,621 | 83,527 | 18.0% |
| 2008 | 483,136 | 66,789 | 13.8% |
| 2009 | 433,764 | 36,482 | 8.4% |
| Total | 2,630,876 | 385,446 | 14.7% |

Unknown Route Issue

Other permits were flagged because the entry in the route contained a highway that could not be recognized in the database. In contrast, if multiple highways were found for a record, this flag was not assigned. The following is an example of route information that was flagged as “unknown route” (Figure 87).

```
[JCT FM0480/SH0027e]SH0027_e, [COMFORT]?BU0087_s$,
IH0010_e,N.SL1604_w,?LA CANTERA (WEST OF IH10)
CROSSUNDER$,SL1604_e,US0281_n,US0190_e,US0183_n,US0281
_n,FM1690_ne,FM0183_ne,US0084_e,S.SL0340_e_n,US0084_e,
W.SL0256_n_e_s,US0079_n,US0259_n,IH0020_e,US0059_n,IH0
030_e
```

Figure 87. Route Descriptions with “Unknown Route” Issue.

In this case, “BU0087” is not shown in the route database, thus the record was flagged for “unknown route.” In addition, there is no route information in “LA CANTERA (WEST OF IH10) CROSSUNDER,” which would have triggered an “unknown route” flag as well. Table 85 provides a count of records that were flagged because of the “unknown information” condition.

Table 85. Count of Route Descriptions with “Unknown Route” Issue by Year.

| Fiscal Year | Permits with Routes | Unknown Routes | Unknown Routes (%) |
|--------------------|----------------------------|-----------------------|---------------------------|
| 2004 | 387,116 | 129,914 | 33.6% |
| 2005 | 417,263 | 143,640 | 34.4% |
| 2006 | 445,976 | 158,662 | 35.6% |
| 2007 | 463,621 | 184,573 | 39.8% |
| 2008 | 483,136 | 171,542 | 35.5% |
| 2009 | 433,764 | 158,662 | 36.6% |
| Total | 2,630,876 | 946,993 | 36.0% |

Multi-Spur Route Issue

A small number of permits were flagged because the entry in the route contained a highway designated as a spur with multiple matches in the route description. The following is an example of route information that was flagged as “multi-spur” (Figure 88).

```
[JCT. IH0035/S.SL0013E]S.SL0013_e, ?SP0122_s$,
IH0410_e_n, US0087_s , [SAN ANTONIO]E.SL1604_e_n,
IH0035_n, [BUDA]S. FM1626_n_e, FM2304_n, [JCT SLAUGHTER
LN...P/U S.SL0001ne]S.SL0001_ne , FM0734_se, IH0035_n,
FM0093_e, SH0095_n, [TEMPLE]S.SL0363_n_w, IH0035_s, [JCT
SH0053]
```

Figure 88. Route Descriptions with “Multi-Spur Route” Issue.

In the route database, there were records of FS0122 and SS0122. As a result, the research team was unable to determine which one this record referred to, and therefore the record was flagged for “multi-spur.” Table 86 provides a count of records that were flagged because of the “multi-spur” condition.

Table 86. Count of Route Descriptions with “Multi-Spur” Issue by Year.

| Fiscal Year | Permits with Routes | Routes with Multi-Spur | Routes with Multi-Spur (%) |
|--------------------|----------------------------|-------------------------------|-----------------------------------|
| 2004 | 387,116 | 328 | 0.1% |
| 2005 | 417,263 | 404 | 0.1% |
| 2006 | 445,976 | 445 | 0.1% |
| 2007 | 463,621 | 706 | 0.2% |
| 2008 | 483,136 | 830 | 0.2% |
| 2009 | 433,764 | 850 | 0.2% |
| Total | 2,630,876 | 3,563 | 0.1% |

ROUTE START AND ROUTE END PROCESSING

The second portion of the data cleansing process was carried out by the San Antonio task force, focusing on the fields ROUTE_START and ROUTE_END. The purpose of the analysis was to review and clean these fields as needed, to develop data elements that would be useful to provide the longitude and latitude for start and end of each route. These data could then be used for the development of GIS route or origin-destination maps. The data standardization process consisted of six phases and multiple steps, which are described below. Following the description are sections that provide additional process information and examples for each phase separately.

- **Phase 0: Data Conversion.** Phase 0 consisted of converting each fiscal year’s information received from TxDOT from a dBase V format database into a Microsoft Access 2007 database.
- **Phase 1: Remove Duplicates.** Phase 1 consisted of setting aside records with a duplicate permit ID and storing these records in the “duplicates” dataset. Remaining data are stored in “distinct permits” dataset.
- **Phase 2: Remove Null Data.** Phase 2 consisted of separating permit records that do not have a route start, route end, and route description (“is null” dataset).
 - Step 1. Identify “is null” records and store them in the “is null” dataset. This dataset is not further used.
 - Step 2. Identify “is not null” records and store them in the “is not null” dataset. This dataset is used in Phase 3.
- **Phase 3: Identify JCT Records.** Phase 3 consisted of identifying records in the “is not null” dataset (Phase 2, Step 2) that use the term “JCT” (Junction) or a variety of that term in the route description field.

- Step 1. Identify records with a “JCT” (Junction) descriptor in the route description and store in “JCT” dataset.
- Step 2. Identify all records that do not contain a “JCT” descriptor in the route description, and store in the “not JCT” dataset.
- **Phase 4: Identify Valid Route Descriptions.** Phase 4A consisted of parsing both the “JCT” and the “not JCT” dataset for information in the route description field that contained valid route descriptions.
 - Step 1. Manually parse the “JCT” dataset (Phase 3 Step 1) to remove any records that do not contain valid route information, and store in “JCT, not valid route description” dataset.
 - Step 2. Compare “JCT” with “JCT, not valid route description,” and store in “JCT, valid route description” dataset.
 - Step 3. Manually parse the “not JCT” dataset (Phase 3 Step 2) to remove any records that do not contain valid route information, and store in “not JCT, not valid route description” dataset.
 - Step 4. Compare “not JCT” with “not JCT, not valid route description,” and create “not JCT, valid route description” dataset.
- **Phase 5: Remove Duplicate Records in the Duplicates Dataset.** Phase 4B consisted of reviewing the dataset of records with duplicate permit IDs (“duplicates,” Phase 1) and eliminating records where all fields are equal.
 - Identify distinct records of the “duplicates” dataset, and store the result in the “distinct duplicates” dataset.
- **Phase 6: Standardize Route Descriptions.** Phase 5 consisted of standardizing the content in the route start and route end fields.
 - Step 1. Create a separate database of all 3,119,606 records that only contains the fields ROUTE_START and ROUTE_END.
 - Step 2. Create two separate tables, one that contains distinct route starts, and one that contains distinct route ends. Each table also included a second field for the cleaned version of the route start or route end.
 - Step 3. Manually review distinct route starts and route ends to determine how they can be standardized.
 - Step 3a. Identify all route starts that cannot be identified as a location, and store as “unknown route start locations” dataset.

- Step 3b. Identify all route ends that cannot be identified as a location, and store as “unknown route end locations” dataset.
- Step 3c. Review the “unknown route start locations” and “unknown route end locations” datasets, and determine locations manually.
- Step 4. Create standardized entries for route starts and route ends using the naming convention of the GNIS TX_FEATURES dataset.
- Step 5. Review distinct route starts and modify problematic entries with standardized feature names created in Step 4, and create the “distinct, standardized route starts” dataset.
- Step 6. Review distinct route ends and modify problematic entries with standardized feature names created in Step 4, and create the “distinct, standardized route ends” dataset.
- Step 7. Combine the two datasets created in Steps 5 and 6 into a single table called “route start and end master.” This table includes both route start and route end locations in one column and may include multiple values for a start or end location.
- Step 8. Review the “route start and end master” table for duplicates, and create a “route start end master, no duplicates” dataset.

To aid with the understanding of the process, Table 87 provides a listing of datasets that were created by the six-phase data cleaning process along with a dataset definition and the process phase that produced the dataset.

Table 87. Dataset Definitions during Route Start and Route End Data Processing.

| Phase | Dataset Name | Dataset Definition |
|--------------|---|--|
| 0 | All permits | The permit records provided by TxDOT. |
| 1 | Duplicates | The permit records with duplicate permit ID values. |
| 1 | Total non duplicate permits | All permits minus the duplicates. |
| 2 | Is null | Distinct permits without route information. |
| 2 | Is not null | Distinct permits with route information. |
| 3 | JCT | A portion of the “is not null” dataset that contains the JCT descriptor. |
| 3 | Not JCT | A portion of the “is not null” dataset that does not contain the JCT descriptor. |
| 4 | JCT, valid route description | A portion of the “JCT” dataset that contains valid route description information. |
| 4 | JCT, not valid route description | A portion of the “JCT” dataset that does not contain valid route description information. |
| 4 | Not JCT, valid route description | A portion of the “Not JCT” dataset that contains valid route description information. |
| 4 | Not JCT, not valid route description | A portion of the “Not JCT” dataset that does not contain valid route description information. |
| 5 | Distinct duplicates | All records of the “Duplicates” dataset except those that appear multiple times in the “Duplicates” dataset. |
| 6 | Unknown route start locations | A list of route start values assembled from all permits that cannot be easily identified as a location. |
| 6 | Unknown route end locations | A list of route end values assembled from all permits that cannot be easily identified as a location. |
| 6 | Distinct, standardized route starts | A list of distinct route start values assembled from all permits that have been standardized using the GNIS TX_FEATURES dataset. |
| 6 | Distinct, standardized route ends | A list of distinct route end values assembled from all permits that have been standardized using the GNIS TX_FEATURES dataset. |
| 6 | Route start and end master | The combination of the datasets “Distinct, standardized route starts” and “Distinct, standardized route ends.” |
| 6 | Route start and end master, no duplicates | The “Route start and end master” dataset without any duplicate entries. |

Phase 0

At the beginning of the analysis, the research team imported each fiscal year's information into a Microsoft Access 2007 databases using a Microsoft Access 2003 format, creating the "All permits" dataset.

Phase 1

For Phase 1, the research team reviewed the permit dataset for duplicate records, using the primary key "PERMIT_NBR." The research team found that a small number of records, about 0.5 percent of all permits, had duplicate permit IDs but different associated data. For example, the same permit number may have been issued for two trucks with different axle configurations and loads (Table 88).

Table 88. Sample of Records with Duplicate Permit Numbers.

| Permit Number | Load Description | Axle Spacing 1 | Axle Spacing 2 | Axle Spacing 3 | Axle Spacing 4 | Axle Spacing 5 |
|---------------|---------------------------------|----------------|----------------|----------------|----------------|----------------|
| ...0423 | Windmill base section | 14 | 4 | 4 | 32 | 4 |
| ...0423 | Windmill base section | 19 | 4 | 66 | 4 | 4 |
| ...0136 | Solar turbine | 15 | 4 | 27 | 4 | 4 |
| ...0136 | Solar turbine | 12 | 4 | 4 | 36 | 4 |
| ...0136 | Solar turbine | 13 | 4 | 33 | 4 | 0 |
| ...0152 | Crane | 4 | 14 | 5 | 0 | 0 |
| ...0152 | Crane | 7 | 5 | 6 | 5 | 0 |
| ...0152 | Crane | 16 | 4 | 29 | 4 | 4 |
| ...0151 | Well Service Unit (S/P mileage) | 4 | 14 | 4 | 4 | 0 |
| ...0151 | Well Service Unit (S/P mileage) | 17 | 4 | 0 | 0 | 0 |
| ...0151 | Well Service Unit (S/P mileage) | 19 | 4 | 38 | 4 | 0 |

Because of the potential for problems during the data analysis, the research team removed duplicate records from the dataset into a dataset called "Duplicates" and used only the dataset of total non-duplicate permits for the subsequent analysis. Table 89 shows the number of duplicate records in the dataset by fiscal year.

Table 89. Duplicate Permit Records.

| Fiscal Year | All Permits | Duplicate Permits | Total Non Duplicate Permits | Total Non Duplicate Permits (% of All) |
|--------------------|--------------------|--------------------------|------------------------------------|---|
| 2004 | 445,081 | 1,497 | 443,584 | 99.7% |
| 2005 | 482,230 | 6,810 | 475,420 | 98.6% |
| 2006 | 523,474 | 1,554 | 521,920 | 99.7% |
| 2007 | 556,338 | 3,768 | 552,570 | 99.3% |
| 2008 | 582,583 | 4,329 | 578,254 | 99.3% |
| 2009 | 529,900 | 4,889 | 525,011 | 99.1% |
| Total | 3,119,606 | 22,847 | 3,096,759 | 99.3% |

Phase 2

For Phase 2, the research team reviewed the content of the route start and route end fields, and found that several records did not contain any values. The research team divided the data into two separate datasets, the “is null” dataset and the “is not null” dataset, as follows:

- **Is Null Dataset (Distinct Permits *without* Route Start, Route End, and Route Description).** The “is null” dataset contains permit records that do not have a route start, route end, and route description, i.e., all three fields have to be empty. Other fields of the permit record such as permit start date and permit end date may be populated. This dataset consists of 487,546 records.
- **Is Not Null Dataset (Distinct Permits *with* Route Start, Route End, and Route Description).** The “is not null” dataset contains permit records that have a route start, route end, and a route description. This dataset contained the data that the research team further analyzed with a total of 2,609,213 records.

Table 90 shows the number of permits that did contain values in the route start and route end fields, and the percentage out of all distinct permits by fiscal year. Over the last six fiscal years, 84 percent of the records contained a route start and end, for a total of about 2.6 million records.

Table 90. Permits with Route Start and Route End Entries.

| Fiscal Year | Total Non-Duplicate Permits | Is Null | Is Not Null | Is Not Null (% of Total Non-Duplicate Permits) |
|--------------------|------------------------------------|----------------|--------------------|---|
| 2004 | 443,584 | 57,672 | 385,912 | 87.3% |
| 2005 | 475,420 | 64,173 | 411,247 | 86.5% |
| 2006 | 521,920 | 77,482 | 444,438 | 85.2% |
| 2007 | 552,570 | 92,692 | 459,878 | 83.2% |
| 2008 | 578,254 | 99,436 | 478,818 | 82.8% |
| 2009 | 525,011 | 96,091 | 428,920 | 81.7% |
| Total | 3,096,759 | 487,546 | 2,609,213 | 84.3% |

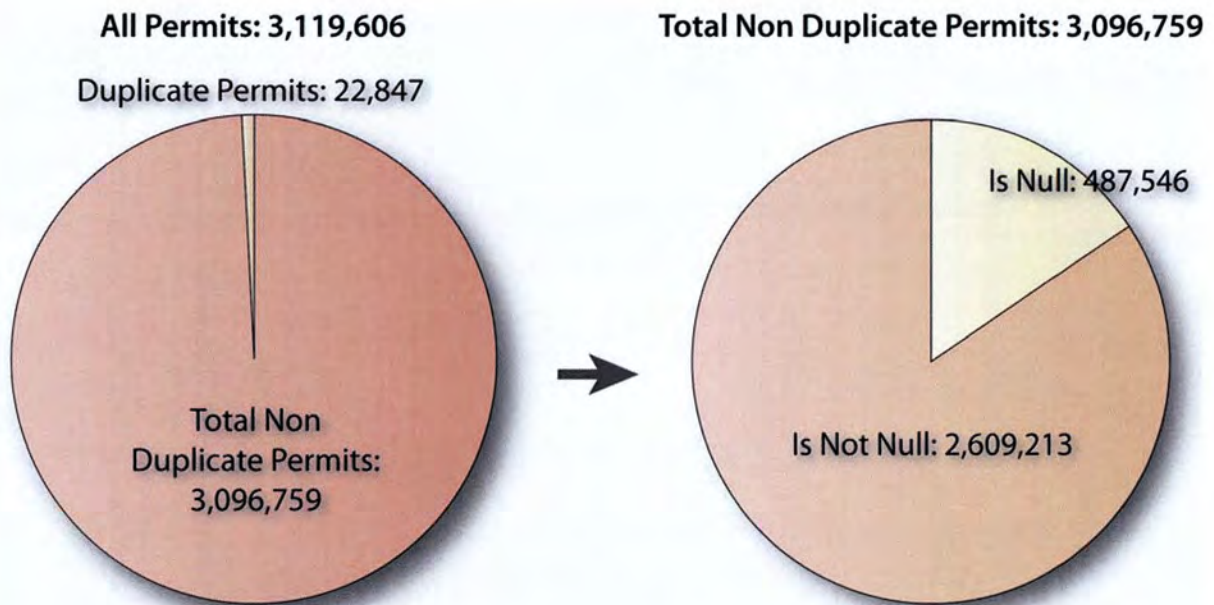

Figure 89. Development of Is Null and Is Not Null Datasets.

Phase 3

In Phase 3, the research team reviewed the route description field of the “is not null” dataset for occurrences of the term JCT to create the “JCT” dataset and the “not JCT” dataset. Table 91 provides a sample of the “JCT” dataset.

Table 91. Sample of "JCT" Dataset.

| |
|--|
| <p>...JCT OK State Line/US60sw, FM282w, FM283n, JCT Quarterhorse Rd...</p> <p>Certificate Information</p> <p>Number: 005094046C Status: Active</p> |
| <p>...JCT OK State Line/US69se, US82e, Paris:W.LP286s/e/n, US271se, US67e, US259s, IH20w, SH42s, SH31se, JCT SH135...</p> <p>ICC# 348837</p> |
| <p>...JCT OK State Line/US75s, FM691w, FM1417s, US82w, US377s, US380w, Denton:E.LP288n/w, IH35s, IH35Ws, Fort Worth:N.IH820w/s, IH20w, US281s, Lampasas:S.US183s, US190w, US281s, San Antonio:N.LP1604e/s, IH35s, N.IH410s/w, IH35s, Laredo:N.LP20sw, FM1472se, JC</p> |
| <p>...JCT OK State Line/US75s, SH91s, FM120e, US69s, US82e, Paris:W.LP286s/e, SH19s, ** IH30SFR, SH154s, SH37s, **US69se, IH20NFRw to the 1st x-over, IH20e, US69se, Tyler:N.LP323e/s/w, SH110s, US84w, US69se, SH7sw, SH103e, Lufkin:W.LP287s/e, US59s, Livingst</p> |
| <p>...JCT OK State Line/US75s, US69se, JCT US82...</p> |
| <p>...JCT OK State Line/US75s, US82e, SH78s, Bonham:SP205e/s, SH56w, SH78s/w, US69s, Tyler:N.323e/s/w, SH110se, JCT Shiloh Rd x-ing FM2964, x-ing FM756, P/U Shiloh Rd/US69s,</p> <p>US175w, SH155s, Palestine:N.LP256e/s, US84w, IH45s, Houston:N.LP8FR, US90w, E.IH</p> |
| <p>...JCT OK State Line/US75s, US82e, US69s, Tyler:N.LP323e/s/w, SH110se, FM2964s, JCT Shiloh Rd, x-ing FM756, P/U @ Shiloh Rd/US69s, Lufkin:N.LP287s/e, US59s, FM3460s, FM2914w, US59s, N.LP8FR, **to 1st turnaround S. of Houston:BU90, E.LP8FRn, **Houston:B</p> |
| <p>...JCT OK State Line/US75s, US82e, US69s, Tyler:N.LP323e/s/w, SH110se, FM2964s, JCT Shiloh Rd, x-ing FM756, P/U @ Shiloh Rd/US69s, Lufkin:N.LP287s/e, US59s, FM3460s, FM2914w, US59s, N.LP8FR, to 1st turnaround S. of Houston:BU90, E.LP8FRn, Houston:BU90e</p> |
| <p>...JCT OK State Line/US75s, US82w, Denton:IH35s, IH35Ws, Fort Worth:N.IH820w/s, IH20w, US281s, Lampasas:S.US183s, US190w, US281s, San Antonio:N.LP1604w/s, SH16se, W.IH410s, IH35s, Laredo:N.LP20sw, FM1472nw, JCT E.O.S.M</p> <p>Spring Branch:US281:use center of</p> |

Table 92 provides the totals of route descriptions with an occurrence of “JCT” and those without. More than 90 percent of the record with route start, route end, and route description included an occurrence of “JCT” in the route description.

Table 92. Permits with “JCT” Occurrence in Route Description.

| Fiscal Year | Is Not Null | Not JCT (Permits without “JCT” Occurrence) | JCT (Permits with “JCT” Occurrence) | JCT (% of Is Not Null) |
|--------------------|--------------------|---|--|-----------------------------------|
| 2004 | 385,912 | 28,490 | 357,422 | 92.6% |
| 2005 | 411,247 | 29,866 | 381,381 | 92.7% |
| 2006 | 444,438 | 34,421 | 410,017 | 92.3% |
| 2007 | 459,878 | 34,878 | 425,000 | 92.4% |
| 2008 | 478,818 | 36,426 | 442,392 | 92.4% |
| 2009 | 428,920 | 32,637 | 396,283 | 92.4% |
| Total | 2,609,213 | 196,718 | 2,412,495 | 92.5% |

Phase 4

For Phase 4, the research team reviewed the route information in the “JCT” and “not JCT” datasets. Since both datasets included valid route descriptions, the research team separated those records that did not include valid route information and created four datasets:

- “JCT, valid route description.”
- “JCT, not valid route description.”
- “not JCT, valid route description.”
- “not JCT, not valid route description.”

Table 93 provides a sample of route information that could not be validated, and Table 94 provides the totals for the four datasets by fiscal year. Although the datasets “JCT, not valid route description” and “not JCT, not valid route description” do not contain any useful route information, they may include useful route start and route end information. Figure 89 shows the size of the datasets from Phase 1 to Phase 4.

Table 93. Sample of Invalid Route Information in Route Description Field.

| |
|---|
| <p>*SEE ATTACHED SHEETS FOR ROUTE AND RESTRICTION INFORMATION*</p> <p>*PERMIT VOID UNLESS ATTACHED SHEETS ACCOMPANY PERMIT*</p> <p>ROUTE INSPECTION ON FILE - T\MAMMOET\BRIDGEPORT TO GIBTOWN</p> <p>*LOCAL LAW ENFORCEMENT MAY NOT REDIRECT THIS LOAD OVER ANY BRIDGE NOT LISTE</p> |
| <p>see attached sheets for routing and restrictions</p> <p>accompanying sheets must be attached or permit is void</p> <p>file code:t\turner\hou-glen</p> <p>total weight is 656,000 lb.</p> <p>AMEND DATE DUE TO WEATHER @ 08:10 ON 10-30-03 BY LEE CARTER</p> |
| <p>564</p> |
| <p>ANY STATE MAINTAIN HWY</p> |
| <p>*SEE ATTACHED SHEETS FOR ROUTE AND RESTRICTION INFORMATION*</p> <p>*PERMIT VOID UNLESS ATTACHED SHEETS ACCOMPANY PERMIT*</p> <p>*ROUTE INSPECTION ON FILE - T\PALLETIZED\GAL-HOU*</p> <p>*LOCAL LAW ENFORCEMENT MAY NOT REDIRECT THIS LOAD OVER ANY BRIDGE NOT LISTED ON THE</p> |
| <p>*SEE ATTACHED SHEETS FOR ROUTE AND RESTRICTION INFORMATION*</p> <p>*PERMIT VOID UNLESS ATTACHED SHEETS ACCOMPANY PERMIT*</p> <p>*ROUTE INSPECTION ON FILE - T\PALLETIZED\GAL-HOU*</p> <p>*LOCAL LAW ENFORCEMENT MAY NOT REDIRECT THIS LOAD OVER ANY BRIDGE NOT LISTED ON THE P</p> |

Table 94. “JCT” and “Not JCT” Permits with and without Valid Route Descriptions.

| Fiscal Year | Distinct Permits with Route Start, End, and Description | JCT, Valid Route Descriptions | JCT, not Valid Route Descriptions | Not JCT, Valid Route Description | Not JCT, Not Valid Route Description |
|--------------|---|-------------------------------|-----------------------------------|----------------------------------|--------------------------------------|
| 2004 | 385,912 | 200,628 | 156,794 | 18,124 | 10,366 |
| 2005 | 411,247 | 223,838 | 157,543 | 19,547 | 10,319 |
| 2006 | 444,438 | 381,641 | 28,376 | 29,650 | 4,771 |
| 2007 | 459,878 | 403,240 | 21,760 | 30,592 | 4,286 |
| 2008 | 478,818 | 438,969 | 3,423 | 33,386 | 3,040 |
| 2009 | 428,920 | 373,699 | 22,584 | 29,289 | 3,348 |
| Total | 2,609,213 | 2,022,015 | 390,480 | 160,588 | 36,130 |

Is Not Null Permits: 2,609,213

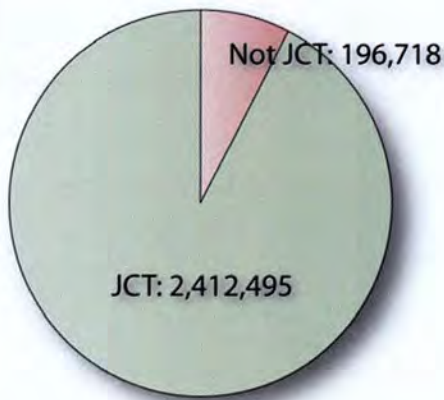

Is Not Null Permits: 2,609,213

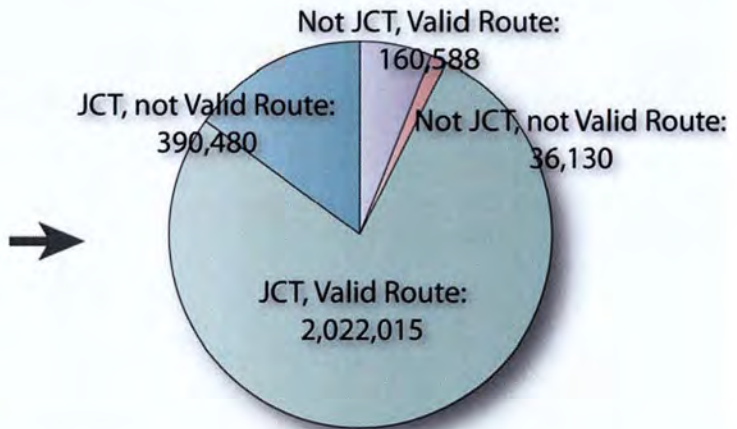

Figure 90. Development of JCT and Not JCT Datasets.

Phase 5

For Phase 5, the research team reviewed the dataset of duplicate records created in Phase 1 and eliminated all records where not only the Permit ID was identical, but the complete record was identical. This dataset was needed for a subsequent step of the data processing. The research team called the resulting dataset “distinct duplicates.”

Table 95. Distinct Duplicate Permit Records.

| Fiscal Year | All Permits | Duplicates | Distinct Duplicates |
|--------------------|--------------------|-------------------|----------------------------|
| 2004 | 445,081 | 1,497 | 743 |
| 2005 | 482,230 | 6,810 | 3,343 |
| 2006 | 523,474 | 1,554 | 776 |
| 2007 | 556,338 | 3,768 | 2,157 |
| 2008 | 582,583 | 4,329 | 2,135 |
| 2009 | 529,900 | 4,889 | 2,435 |
| Total | 3,119,606 | 22,847 | 11,589 |

Phase 6

For Phase 6, the research team processed information in the route start and route end fields. The goal was to process and standardize the information in a way that would enable an automated GIS process to use the information. As provided, the route start and route end information was not immediately useable. For example, city names in the route start field appeared in a multitude of standards and spellings, and appeared to be entered without spell checking the entry. Table 96 provides a sample of inconsistent spellings of cities in the route start field.

Table 96. Sample Spellings of Cities in the Start Route Field.

| Sample Values in Field ROUTE_START |
|---------------------------------------|
| * SAN ANTONIO * |
| \SAN ANTONIO |
| MSAN ANTONIO |
| **HOUSTON** |
| 0HOUSTON |
| HOUST6ON |
| ☺CORPUS CHRIST |
| CORPUS |
| CORPUS CHRI |
| 1DALLAS |
| DALLAS |
| DA;;AS |
| AAMARILLO |
| AMARILLO |
| AMARILLO |

The research team created two separate tables, one that contained distinct route starts and one that contained distinct route ends. Each table also included a second (empty) field for the cleaned version of the route start or route end, called ROUTE_ORIGIN and ROUTE_DESTINATION. The research team then manually reviewed distinct route starts and route ends to determine how they can be standardized. The research team began this process by identifying all route starts that could be easily identified and stored the remaining locations as the “unknown route start locations” dataset. Table 97 provides a sample of route start locations that could not be immediately identified.

In the next step, the researchers repeated the process for the route end field, and stored locations that could not be immediately identified in the “unknown route end locations” dataset. The step that followed reviewed both the “unknown route start locations” and the “unknown route end locations” datasets and attempted to determine the actual locations using a manual process.

Table 97. Sample Unknown Route Start Locations.

| |
|----------------------|
| 6 MILES SOUTH OF LEH |
| A;VARADO |
| ASDF |
| CIT |
| DESSA |
| R.R.A.D |
| SSS |
| T.S.L. |
| UFKIN |
| UNCERTAIN |
| VARIES |

The research team then created standardized entries for all route starts and route ends using the naming convention of the GNIS TX_FEATURES dataset. Subsequently, the research team added the standardized name in the previously empty fields ROUTE_ORIGIN and ROUTE_DESTINATION that the researchers added at the start of this phase. The results of this process were two datasets, the “distinct, standardized route starts” dataset, and the “distinct, standardized route ends” dataset. Table 98 provides a sample of records from the “distinct, standardized route starts” table.

Table 98. Sample Standardized Route Start Values.

| Route Start | Route Origin |
|----------------------|----------------|
| * SAN ANTONIO * | San Antonio |
| \SAN ANTONIO | San Antonio |
| MSAN ANTONIO | San Antonio |
| **HOUSTON** | Houston |
| 0HOUSTON | Houston |
| HOUST6ON | Houston |
| ☺CORPUS CHRIST | Corpus Christi |
| CORPUS | Corpus Christi |
| CORPUS CHRI | Corpus Christi |
| 1DALLAS | Dallas |
| DALLAS | Dallas |
| DA;;AS | Dallas |
| AAMARILLO | Amarillo |
| AMARILLO | Amarillo |
| AMARILLLO | Amarillo |

In the next step, the researchers combined the two datasets “distinct, standardized route starts” and “distinct, standardized route ends” into a single table called “route start and end master,” which included both route start and route end locations in one column. However, many of the start locations were also end locations and vice versa, so it was necessary to review the “route start and end master” table for duplicates, remove the duplicates, and create a “route start end master, no duplicates” dataset.

Table 99. Count of Records in Route Start and End Datasets.

| Distinct, Standardized Route Starts | Distinct, Standardized Route Ends | Route Start and End Master | Route Start and End Master, No Duplicates |
|--|--|-----------------------------------|--|
| 31,860 | 41,137 | 72,997 | 58,236 |

FINAL DATA PROCESSING AND MERGE

In the final data processing and merge step, the researchers combined datasets from Phase 6 to create datasets for the development of GIS maps. The merge was completed in two phases and multiple steps, as follows:

- **Phase 7: Import All Route Descriptions.** Phase 7 consisted of preparing the cleaned route description field that was processed by the College Station task force to the dataset.
 - Step 1. Import Excel spreadsheet information into Microsoft Access 2007 database using Access 2003 format, and create “all processed route descriptions” dataset.
- **Phase 8: Merge Datasets.** Phase 8 consisted of combining databases created in previous steps.
 - Step1. Create the “Distinct duplicates merge” dataset.
 - Step 1a. Merge the “Distinct duplicates” dataset created in Phase 5 with the “Route start and end master, no duplicates” (Phase 6) and the “all processed route descriptions” dataset (Phase 7) to create the fields ROUTE_ORIGIN, ROUTE_DESTINATION, and ROUTE_PATH.
 - Step 1b. Group the result of the dataset created in Step 1a by Permit ID to remove records that are duplicates.
 - Step 2. Merge the “JCT, valid route descriptions” dataset (Phase 4) with the “Route start and end master, no duplicates” (Phase 6) and the “all processed route descriptions” dataset (Phase 7) to create the fields ROUTE_ORIGIN, ROUTE_DESTINATION, and ROUTE_PATH in the “JCT, valid route descriptions, merge” dataset.

- Step 3: Merge the “Not JCT, valid route descriptions” dataset (Phase 4) with the “Route start and end master, no duplicates” (Phase 6) and the “All processed route descriptions” dataset (Phase 7) to create the fields ROUTE_ORIGIN, ROUTE_DESTINATION, and ROUTE_PATH in the “Not JCT, valid route descriptions, merge” dataset.
- Step 4: Merge the “JCT, *not* valid route descriptions” dataset (Phase 4) with the “Route start and end master, no duplicates” (Phase 6) and the “All processed route descriptions” dataset (Phase 7) to create the fields ROUTE_ORIGIN, ROUTE_DESTINATION, and ROUTE_PATH in the “JCT, not valid route descriptions, merge” dataset.
- Step 5: Merge the “Not JCT, *not* valid route descriptions” dataset (Phase 4) with the “Route start and end master, no duplicates” (Phase 6) and the “All processed route descriptions” dataset (Phase 7) to create the fields ROUTE_ORIGIN, ROUTE_DESTINATION, and ROUTE_PATH in the “Not JCT, not valid route descriptions, merge” dataset.
- Step 6: For route processing in a GIS, merge the datasets created in Steps 1, 2, and 3, and store in “Path” dataset.
- Step 7: For route start and route end processing in a GIS, merge the datasets created in Steps 4 and 5, and store in “Origin destination” dataset.

To aid with the understanding of the process, Table 100 provides a listing of datasets that are created by the data merging process along with a dataset definition and the process step that produces the dataset.

Phase 7

Phase 7 prepared the dataset processed by the College Station task force for subsequent merging in Phase 8. The main task of this phase was to import the data from an Excel spreadsheet into a Microsoft Access 2007 database using Access 2003 format. The researchers called this dataset the “all processed route descriptions” dataset.

Table 100. Dataset Definitions during Final Data Processing.

| | | |
|---|--|--|
| 7 | All processed route descriptions | A merge of the clean route descriptions and flagged route descriptions datasets of the 5-Step route description cleaning process. |
| 8 | Distinct duplicates merge | A merge of the datasets “distinct duplicates,” “route start and end master, no duplicates,” and “all processed route descriptions.” |
| 8 | JCT, valid descriptions, merge | A merge of the datasets “JCT, valid route descriptions,” “route start and end master, no duplicates,” and “all processed route descriptions.” |
| 8 | Not JCT, valid route descriptions, merge | A merge of the datasets “Not JCT, valid route descriptions,” “route start and end master, no duplicates,” and “all processed route descriptions.” |
| 8 | JCT, not valid route description, merge | A merge of the datasets “JCT, <i>not</i> valid route descriptions,” “route start and end master, no duplicates,” and “all processed route descriptions.” |
| 8 | Not JCT, not valid route descriptions, merge | A merge of the datasets “Not JCT, <i>not</i> valid route descriptions,” “route start and end master, no duplicates,” and “all processed route descriptions.” |
| 8 | Path | A merge of the datasets “Distinct duplicates merge,” “JCT, valid route descriptions, merge,” and “Not JCT, valid route descriptions merge.” |
| 8 | Origin destination | A merge of the datasets “JCT, <i>not</i> valid route description, merge” and “Not JCT, <i>not</i> valid route description, merge.” |

Phase 8

This phase focused on the merging of several datasets to produce the final, clean datasets for GIS processing. In the first step, the researchers merged the datasets “distinct duplicates” created in Phase 5 with the “route start and end master, no duplicates” (Phase 6) and the “all processed route descriptions” dataset (Phase 7) to create the fields ROUTE_ORIGIN, ROUTE_DESTINATION, and ROUTE_PATH in the dataset “Distinct duplicates, merge.” ROUTE_ORIGIN contains the standardized location definition from the “Route start and end master, no duplicates” that refers to the original location definition in the route start field of the “Distinct duplicates” dataset. Similarly, ROUTE_DESTINATION contains the standardized location definition from the “route start and end master, no duplicates” that refers to the original location definition in the route end field of the “Distinct duplicates” dataset. Further, ROUTE_PATH contains the processed routing information from the “all processed route descriptions” dataset. Table 101 provides an overview of the counts for the merged datasets.

Table 101. Merged Datasets from Step 8.

| Fiscal Year | Distinct Permits without Nulls | Path | | | Origin Destination | |
|--------------|--------------------------------|---------------------------|------------------------------------|---|---|--|
| | | Distinct Duplicates Merge | JCT Valid Route Description, Merge | Not JCT, Valid Route Description, Merge | JCT, Not Valid Route Description, Merge | Not JCT, Not Valid Route Descriptions, Merge |
| 2004 | 386,655 | 743 | 200,628 | 18,124 | 156,794 | 10,366 |
| 2005 | 414,590 | 3,343 | 223,838 | 19,547 | 157,543 | 10,319 |
| 2006 | 445,214 | 776 | 381,641 | 29,650 | 28,376 | 4,771 |
| 2007 | 462,035 | 2,157 | 403,240 | 30,592 | 21,760 | 4,286 |
| 2008 | 480,953 | 2,135 | 438,969 | 33,386 | 3,423 | 3,040 |
| 2009 | 431,355 | 2,435 | 373,699 | 29,289 | 22,584 | 3,348 |
| Total | 2,620,802 | 11,589 | 2,022,015 | 160,588 | 390,480 | 36,130 |

Table 102 provides an overview of the counts for the datasets “Origin destination” and “Path.” Out of the 2.62 million records of distinct permits without nulls, the research team was able to create a dataset with detailed route information for 2.19 million records, or about 84 percent. The remaining 16 percent of data (0.42 million records) provide origin and destination data only.

Table 102. Counts of Records for the Origin Destination and Path Datasets.

| Fiscal Year | Distinct Permits without Nulls | Origin Destination | Path | Path (% of Distinct Permits without Nulls) |
|--------------|--------------------------------|--------------------|------------------|--|
| 2004 | 386,655 | 167,160 | 219,495 | 56.8% |
| 2005 | 414,590 | 167,862 | 246,728 | 59.5% |
| 2006 | 445,214 | 33,147 | 412,067 | 92.6% |
| 2007 | 462,035 | 26,046 | 435,989 | 94.4% |
| 2008 | 480,953 | 6,463 | 474,490 | 98.7% |
| 2009 | 431,355 | 25,932 | 405,423 | 94.0% |
| Total | 2,620,802 | 426,610 | 2,194,192 | 83.7% |

Figure 91 is a graphical representation of the six datasets that make up the complete dataset of 2.6 million records of distinct permits without nulls, and how these datasets were combined to form the “Path” and “Origin destination” datasets.

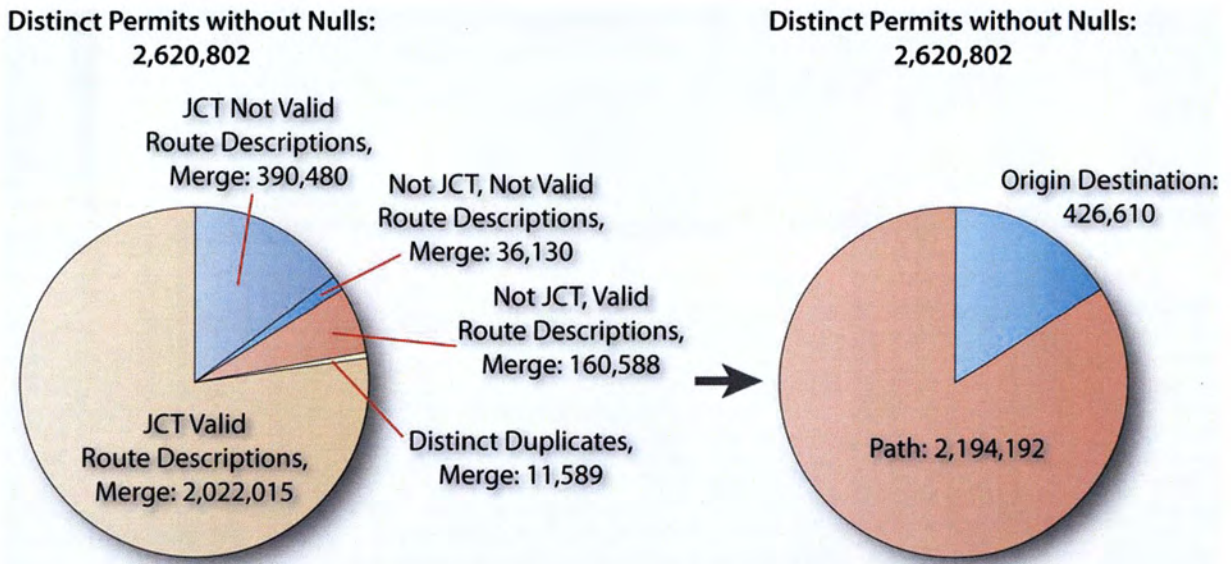

Figure 91. Development of Origin Destination and Path Datasets.

Figure 92 provides a relationship view of the query in Access followed by the syntax of the query in SQL.

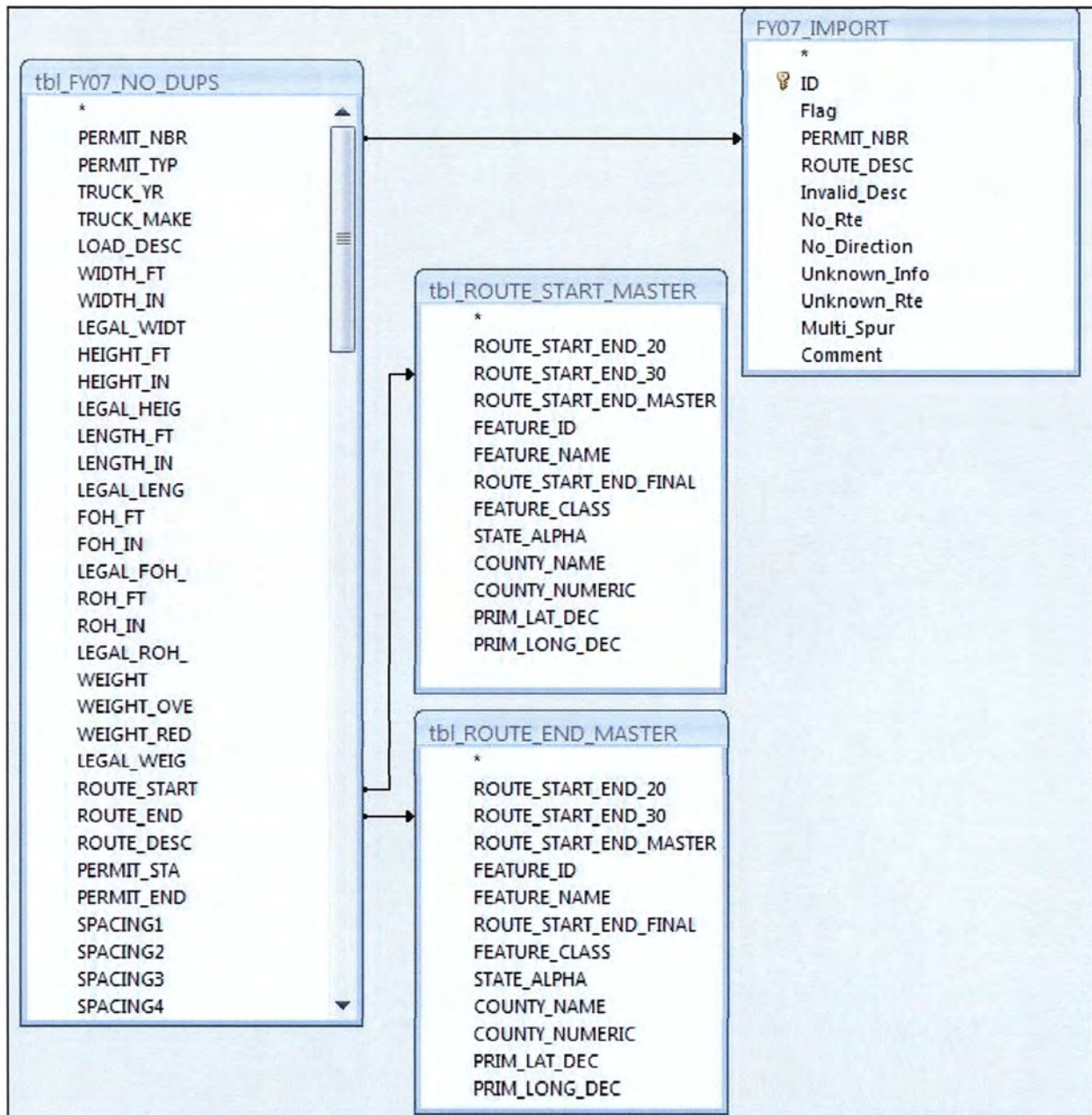

Figure 92. Query for Merging of “Distinct Duplicates,” “Route Start and End Master, No Duplicates,” and “All Processed Route Descriptions” Datasets, Access Design View.

The SQL statement for the query in Figure 92 is as follows:

```

SELECT tbl_FY07_NO_DUPS.PERMIT_NBR, tbl_FY07_NO_DUPS.PERMIT_TYP,
tbl_FY07_NO_DUPS.TRUCK_YR, tbl_FY07_NO_DUPS.TRUCK_MAKE,
tbl_FY07_NO_DUPS.LOAD_DESC, tbl_FY07_NO_DUPS.WIDTH_FT, tbl_FY07_NO_DUPS.WIDTH_IN,
tbl_FY07_NO_DUPS.LEGAL_WIDT, tbl_FY07_NO_DUPS.HEIGHT_FT, tbl_FY07_NO_DUPS.HEIGHT_IN,
tbl_FY07_NO_DUPS.LEGAL_HEIG, tbl_FY07_NO_DUPS.LENGTH_FT, tbl_FY07_NO_DUPS.LENGTH_IN,
tbl_FY07_NO_DUPS.LEGAL LENG, tbl_FY07_NO_DUPS.FOH_FT, tbl_FY07_NO_DUPS.FOH_IN,
tbl_FY07_NO_DUPS.LEGAL_FOH, tbl_FY07_NO_DUPS.ROH_FT, tbl_FY07_NO_DUPS.ROH_IN,
tbl_FY07_NO_DUPS.LEGAL_ROH, tbl_FY07_NO_DUPS.WEIGHT, tbl_FY07_NO_DUPS.WEIGHT_OVE,
tbl_FY07_NO_DUPS.WEIGHT_RED, tbl_FY07_NO_DUPS.LEGAL WEIG,
tbl_FY07_NO_DUPS.ROUTE_START, tbl_FY07_NO_DUPS.ROUTE_END,
tbl_FY07_NO_DUPS.ROUTE_DESC, tbl_ROUTE_START_MASTER.ROUTE_START_END_FINAL AS
ROUTE_ORIGIN, tbl_ROUTE_END_MASTER.ROUTE_START_END_FINAL AS ROUTE_DESTINATION,
FY07_IMPORT.ROUTE_DESC AS ROUTE_PATH, FY07_IMPORT.Flag AS ROUTE_FLAG,
tbl_FY07_NO_DUPS.PERMIT_STA, tbl_FY07_NO_DUPS.PERMIT_END, tbl_FY07_NO_DUPS.SPACING1,
tbl_FY07_NO_DUPS.SPACING2, tbl_FY07_NO_DUPS.SPACING3, tbl_FY07_NO_DUPS.SPACING4,
tbl_FY07_NO_DUPS.SPACING5, tbl_FY07_NO_DUPS.SPACING6, tbl_FY07_NO_DUPS.SPACING7,
tbl_FY07_NO_DUPS.SPACING8, tbl_FY07_NO_DUPS.SPACING9, tbl_FY07_NO_DUPS.SPACING10,
tbl_FY07_NO_DUPS.SPACING11, tbl_FY07_NO_DUPS.SPACING12, tbl_FY07_NO_DUPS.SPACING13,
tbl_FY07_NO_DUPS.SPACING14, tbl_FY07_NO_DUPS.SPACING15, tbl_FY07_NO_DUPS.SPACING16,
tbl_FY07_NO_DUPS.SPACING17, tbl_FY07_NO_DUPS.SPACING18, tbl_FY07_NO_DUPS.SPACING19,
tbl_FY07_NO_DUPS.SPACING20, tbl_FY07_NO_DUPS.SPACING21, tbl_FY07_NO_DUPS.SPACING22,
tbl_FY07_NO_DUPS.SPACING23, tbl_FY07_NO_DUPS.SPACING24, tbl_FY07_NO_DUPS.WEIGHT1,
tbl_FY07_NO_DUPS.WEIGHT2, tbl_FY07_NO_DUPS.WEIGHT3, tbl_FY07_NO_DUPS.WEIGHT4,
tbl_FY07_NO_DUPS.WEIGHT5, tbl_FY07_NO_DUPS.WEIGHT6, tbl_FY07_NO_DUPS.WEIGHT7,
tbl_FY07_NO_DUPS.WEIGHT8, tbl_FY07_NO_DUPS.WEIGHT9, tbl_FY07_NO_DUPS.WEIGHT10,
tbl_FY07_NO_DUPS.WEIGHT11, tbl_FY07_NO_DUPS.WEIGHT12, tbl_FY07_NO_DUPS.WEIGHT13,
tbl_FY07_NO_DUPS.WEIGHT14, tbl_FY07_NO_DUPS.WEIGHT15, tbl_FY07_NO_DUPS.WEIGHT16,
tbl_FY07_NO_DUPS.WEIGHT17, tbl_FY07_NO_DUPS.WEIGHT18, tbl_FY07_NO_DUPS.WEIGHT19,
tbl_FY07_NO_DUPS.WEIGHT20, tbl_FY07_NO_DUPS.WEIGHT21, tbl_FY07_NO_DUPS.WEIGHT22,
tbl_FY07_NO_DUPS.WEIGHT23, tbl_FY07_NO_DUPS.WEIGHT24, tbl_FY07_NO_DUPS.WEIGHT25,
tbl_FY07_NO_DUPS.TIRES1, tbl_FY07_NO_DUPS.TIRES2, tbl_FY07_NO_DUPS.TIRES3,
tbl_FY07_NO_DUPS.TIRES4, tbl_FY07_NO_DUPS.TIRES5, tbl_FY07_NO_DUPS.TIRES6,
tbl_FY07_NO_DUPS.TIRES7, tbl_FY07_NO_DUPS.TIRES8, tbl_FY07_NO_DUPS.TIRES9,
tbl_FY07_NO_DUPS.TIRES10, tbl_FY07_NO_DUPS.TIRES11, tbl_FY07_NO_DUPS.TIRES12,
tbl_FY07_NO_DUPS.TIRES13, tbl_FY07_NO_DUPS.TIRES14, tbl_FY07_NO_DUPS.TIRES15,
tbl_FY07_NO_DUPS.TIRES16, tbl_FY07_NO_DUPS.TIRES17, tbl_FY07_NO_DUPS.TIRES18,
tbl_FY07_NO_DUPS.TIRES19, tbl_FY07_NO_DUPS.TIRES20, tbl_FY07_NO_DUPS.TIRES21,
tbl_FY07_NO_DUPS.TIRES22, tbl_FY07_NO_DUPS.TIRES23, tbl_FY07_NO_DUPS.TIRES24,
tbl_FY07_NO_DUPS.TIRES25, tbl_FY07_NO_DUPS.SIZE1, tbl_FY07_NO_DUPS.SIZE2,
tbl_FY07_NO_DUPS.SIZE3, tbl_FY07_NO_DUPS.SIZE4, tbl_FY07_NO_DUPS.SIZE5,
tbl_FY07_NO_DUPS.SIZE6, tbl_FY07_NO_DUPS.SIZE7, tbl_FY07_NO_DUPS.SIZE8,
tbl_FY07_NO_DUPS.SIZE9, tbl_FY07_NO_DUPS.SIZE10, tbl_FY07_NO_DUPS.SIZE11,
tbl_FY07_NO_DUPS.SIZE12, tbl_FY07_NO_DUPS.SIZE13, tbl_FY07_NO_DUPS.SIZE14,
tbl_FY07_NO_DUPS.SIZE15, tbl_FY07_NO_DUPS.SIZE16, tbl_FY07_NO_DUPS.SIZE17,
tbl_FY07_NO_DUPS.SIZE18, tbl_FY07_NO_DUPS.SIZE19, tbl_FY07_NO_DUPS.SIZE20,
tbl_FY07_NO_DUPS.SIZE21, tbl_FY07_NO_DUPS.SIZE22, tbl_FY07_NO_DUPS.SIZE23,
tbl_FY07_NO_DUPS.SIZE24, tbl_FY07_NO_DUPS.SIZE25 INTO FY07_TxDOT_PERMIT_EXPORT
FROM ((tbl_FY07_NO_DUPS
LEFT JOIN tbl_ROUTE_START_MASTER
ON tbl_FY07_NO_DUPS.ROUTE_START = tbl_ROUTE_START_MASTER.ROUTE_START_END_30)
LEFT JOIN tbl_ROUTE_END_MASTER
ON tbl_FY07_NO_DUPS.ROUTE_END = tbl_ROUTE_END_MASTER.ROUTE_START_END_30)
LEFT JOIN FY07_IMPORT
ON tbl_FY07_NO_DUPS.PERMIT_NBR = FY07_IMPORT.PERMIT_NBR;

```

The researchers repeated this process for the “JCT, valid route descriptions” dataset (Phase 4), merging it also with the “route start and end master, no duplicates” (Phase 6) and the “all processed route descriptions” dataset (Phase 7) to create the fields ROUTE_ORIGIN,

ROUTE_DESTINATION, and ROUTE_PATH in the dataset “JCT, valid route descriptions, merge.” In the next step, the research team repeated this process using the “Not JCT, valid route descriptions” dataset (Phase 4), creating the fields ROUTE_ORIGIN, ROUTE_DESTINATION, and ROUTE_PATH in the dataset “Not JCT, valid route descriptions, merge.” Similarly, the research team created the datasets “JCT, not valid route descriptions, merge” using the “JCT, not valid route descriptions” dataset, and “Not JCT, not valid route descriptions, merge” using the dataset “Not JCT, not valid route descriptions.”

Finally, the researcher merged the datasets “Distinct duplicates, merge,” “JCT, valid route descriptions, merge,” and “Not JCT, valid route descriptions, merge” to create one dataset called “Path.” This dataset was created for GIS processing of the route description. The researchers also merged the datasets “JCT, not valid route descriptions, merge” and “Not JCT, not valid route descriptions, merge” to create one dataset called “Origin destination.” This dataset was created for GIS processing of the route start and route end field. The “Path” dataset will be useful to convert route data to GIS features, which will allow the actual mapping of statewide overweight routes on the transportation system. The “Origin destination” dataset will be useful to develop maps showing the flow of overweight traffic from origins to destinations in Texas.

RECONSTRUCTION OF PERMIT ROUTES

The research team developed a modified shortest path algorithm in ESRI ArcGIS Desktop to reconstruct the overweight permit routes from the route description field. The algorithm directly read and wrote data directly from and to an Oracle database resulting in a dramatically increased processing speed. In addition, it allowed the researchers to execute the process in batches of controllable size, defined by researchers in numbers of data rows.

In order to generate GIS routes from the route descriptions processed in previous steps, researchers developed several GIS programs that involved further data processing. The overall process included the following major steps:

- Preparation of route network.
- Junction layer creation.
- Generation of route shapefiles and attribution.
- Post processing of route shapefiles.

Preparation of Route Network

A required component for creating shapefiles from standardized route descriptions was a navigable route network. The route descriptions only involved on-system routes; local routes between origin or final destination and the nearest access points on a state route were not described. Therefore, it was necessary to construct a route network using a TxDOT roadway network.

The research team received two roadway networks from TxDOT: the official 2008 on-system network from the TxDOT Transportation Planning and Programming Division (TP&P) and the

2009 on-system network used by TxDOT Maintenance Division (MNT) for their Pavement Management Information System (PMIS) and related mapping purposes. Both highway networks were centerline layers that contained only single-line features representing the centerlines of state highway roadbeds.

Since this research involved 2009 permit data, the research team used the 2009 PMIS roadway network as the basis for the route network. Preparing the network required a check of all roadway intersections in the network to ensure the network was fully navigable and correctly reflected ground conditions. Researchers performed this check both manually and programmatically, i.e., by testing connectivity through generating a sample of complex routes. The following are some of the major considerations and challenges the research team encountered during the preparation of the route network.

- **Network connectivity.** Connectivity is a key requirement for a navigable route network. Several factors need to be considered during route network construction to ensure connectivity, including the following:
 - **Grade separations.** Grade separations refer to the cases where a roadway overpasses another roadway without providing vehicles the ability to move from one roadway to the other. These cases would appear as intersections on a PolyLine layer but should not be considered intersections. However, the scope of this research focused strictly on the on-system highways (i.e., major state routes). Most, if not all, intersections between those highways are physically connected either at grade or by ramps or interchanges. Therefore, grade separation was not an issue of concern for this research.
 - **Frontage roads, ramps, and turnarounds.** Most Texas freeways are constructed with frontage roads and use ramps and turnarounds for connection and U-turns. In reality, when a vehicle navigates from a freeway to a non-access controlled highway, it needs to exit the main lanes and then uses a ramp or other connecting road to enter the other highway. However, the route analysis in this research was at the macroscopic level and therefore did not intend to reconstruct detailed intersection movements. Consequently, the roadway network used for this project did not contain microscopic navigation features such as frontage roads, ramps, and turnarounds.
 - **Link errors.** Link errors refer to misrepresentations of ground conditions in the GIS roadway layer due to issues with data accuracy or currentness. During the network construction, the researchers encountered a large number of link errors. Many of these errors only become visible at large zoom levels and are of little concern for typical uses of the network. However, for the purpose of this research, ensuring a connected network was of critical importance. Some of the most frequent link errors included overshoots, undershoots, and broken links, as shown in Figure 93. Undershoots refer to network links that stop short of connecting to the next roadway link, broken links refer to network links that are not connected to the next roadway link, and overshoots refer to network links that (incorrectly)

continue after connecting to the next network link. The research team manually corrected most, if not all of such cases to ensure connectivity.

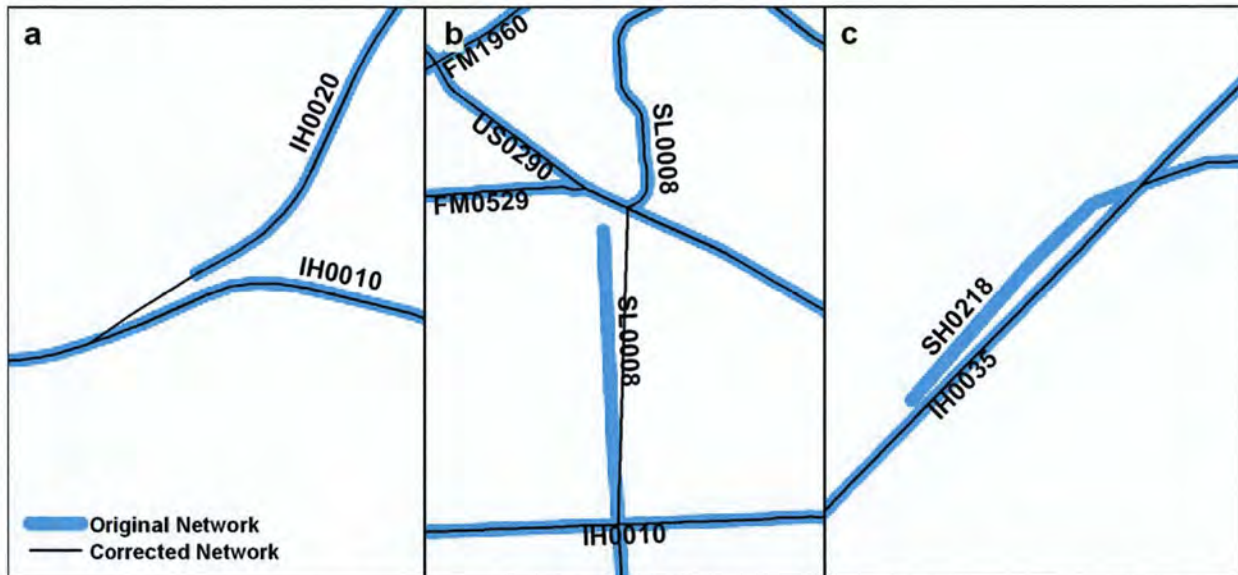

Figure 93. Example of Connectivity Issues in the Original TxDOT Roadway Network (a: Undershoot, b: Broken link, c: Overshoot).

- **Network attributes.** Network attributes are information for each network link such as travel impedance (e.g., traffic information, travel speed, speed limit, and functional classification), directional travel restrictions, and link distances that are needed for route determination. The research team used an approach to reconstructed permit routes by linking the identified intersections using shortest paths and only involved on-system highways. As a result, the only attribute of interest to the research was the link distance available in the original centerline layer.

After making necessary improvements to the 2009 centerline layer, the researchers generated a route network layer using the Network Analyst tool available in ArcGIS Desktop. This route network was used during the subsequent steps for GIS reconstruction of the permit routes. Figure 94 shows the network links and nodes along with a zoomed map insert showing the network for San Antonio.

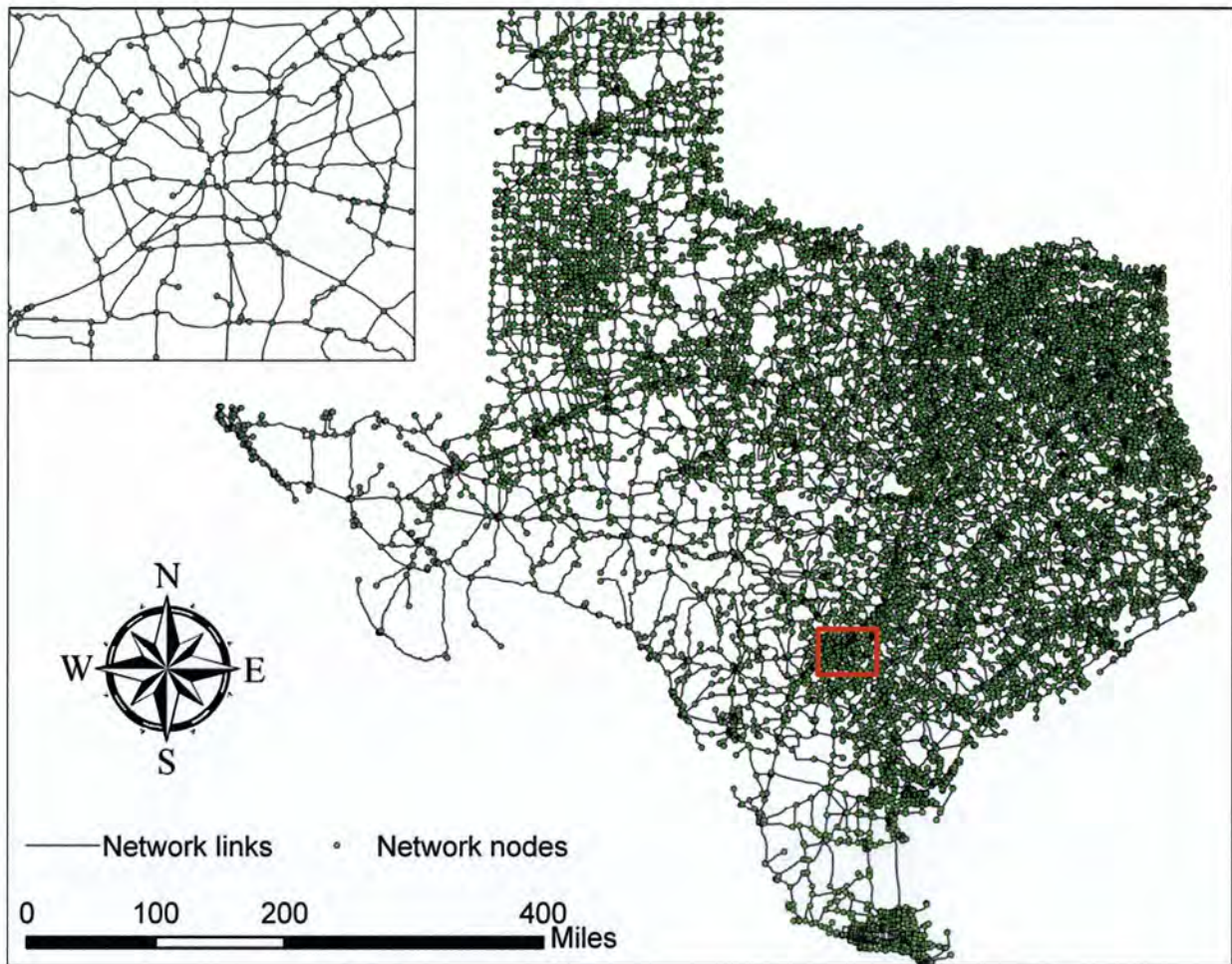

Figure 94. Final Route Network Used for GIS Route Reconstruction.

Junction Layer Creation

Another critical component for the route feature creation was a point layer that corresponded to all intersections, origins, and destinations contained in route descriptions, and was spatially linked to the route network layer. This layer was needed so that for each permit route, the automated route generation program was able to identify the route origin, destination, and all intermediate intersections. Researchers named this layer the “junction layer” for convenience. To generate this layer, researchers needed three types of point features:

- **Highway-state line intersections.** For interstate permit routes, the route descriptions only described the part of the routes that were within Texas state line. For this reason, the origin or destination of such a route would be the intersection between Texas state line and an on-system highway. The research team generated the highway-state line intersections by intersecting the 2009 roadway network layer with a Texas state polygon layer. To ensure accuracy, the research team also manually checked the resulting point layer and added points those that the automated intersecting operation missed.

- Texas cities.** A majority of the permit routes used Texas cities as origins and destinations. Therefore, it was necessary to include all Texas cities in the junction layer. For this purpose, the research team used the 2011 U.S. Geographic Names Information System (GNIS) Populated Place dataset. A point layer of Texas cities was created based on the coordinate information contained in the tabular dataset using the “Display XY Data” tool in ArcGIS Desktop.
- Highway intersections.** The research team generated a point layer of highway intersections by extracting all intersections of the on-system roadway network using the “Intersect” tool in ArcGIS. The resulting layer included many missing junctions and needed extensive manual edits in order to be used for GIS route processing. Missing intersections could be due to several reasons, such as more than two highways intersecting at the same location, and disconnected links at intersections that were not corrected through previous steps. The most frequent cases resulting in missing intersections, however, were network links representing highways with multiple designations (Figure 95a), and highways changing names at intersections (Figure 95b).

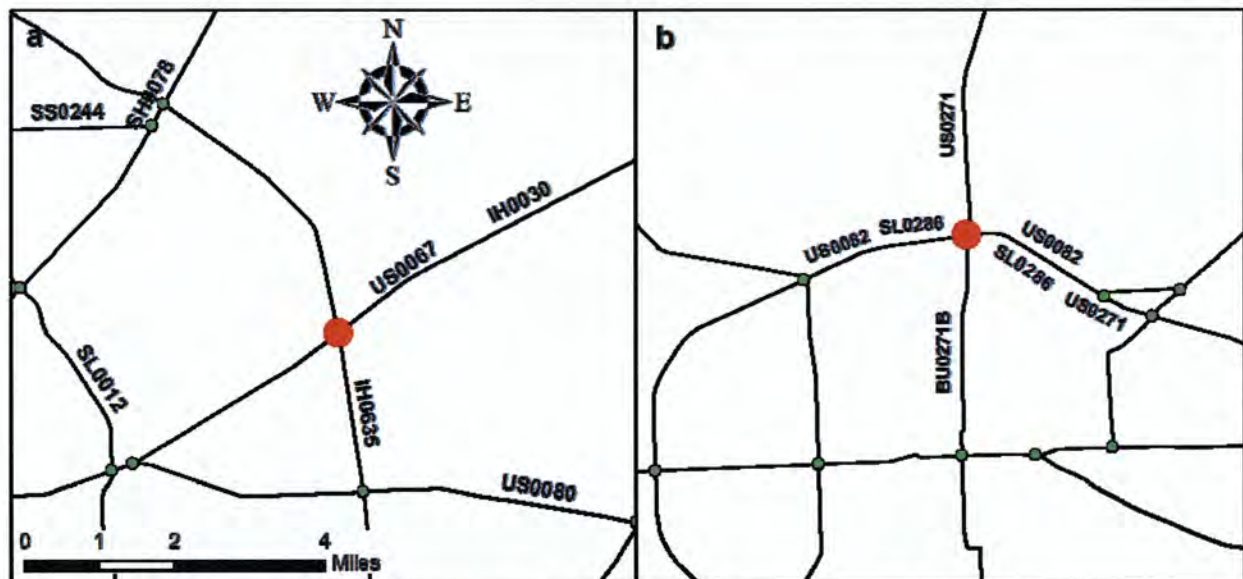

Figure 95. Common Situations Resulting in Missing Intersections.

For example, Figure 95a shows a network link representing a highway with multiple designations, i.e., IH 30 or US 67 in Houston, Texas. Because Interstate designations are more important than US highway designations in the TxDOT functional classification hierarchy, the link on the TxDOT highway network layer used IH0030 as the highway name instead of US0067. Therefore, the automated process generated only one intersection at the location indicated in Figure 95a: IH 635 with IH 30. However, some route descriptions use the designation US 67. Therefore, the researchers had to manually add an intersection point for IH 635 and US 67.

Figure 95b shows highway US 271 intersecting with highway US 82 north of Paris, Texas. East of this intersection, the highway has a triple designation as US 271, US 82,

and SL 286, south of this intersection US 271 continues as Business US 271 (BU0271B), and west of the intersection it has a dual designation of US 82 and SL 286. Because of the name change of US 271, there was a new route feature for Business US 287 that did not physically intersect with the route feature of US 82 on the network layer. As a result, the intersect operation only produced an intersection point between US 271 and US 82. However, the research team needed intersection points for all unique combinations of intersecting highways: US 271 with SL 286, US 82, and Business US 271; and Business US 271 with SL 286 and US 82. The researchers manually added the missing intersections points.

The research team combined all three types of point features into a single junction layer (Figure 96). To match the junctions in route descriptions with the corresponding spatial point representations, the junction layer included the following two key attributes: Highway 1 and Highway 2. In the case of highway intersections, these two fields stored the names of the two intersecting highways with no particular sequence. In the case of highway-state line intersections, Highway 1 stored the name of the state line (e.g., LA STATE LINE, NM STATE LINE, AR STATE LINE, OK STATE LINE, and MX STATE LINE). For cities, Highway 1 included CITY to indicate the record represented a Texas city.

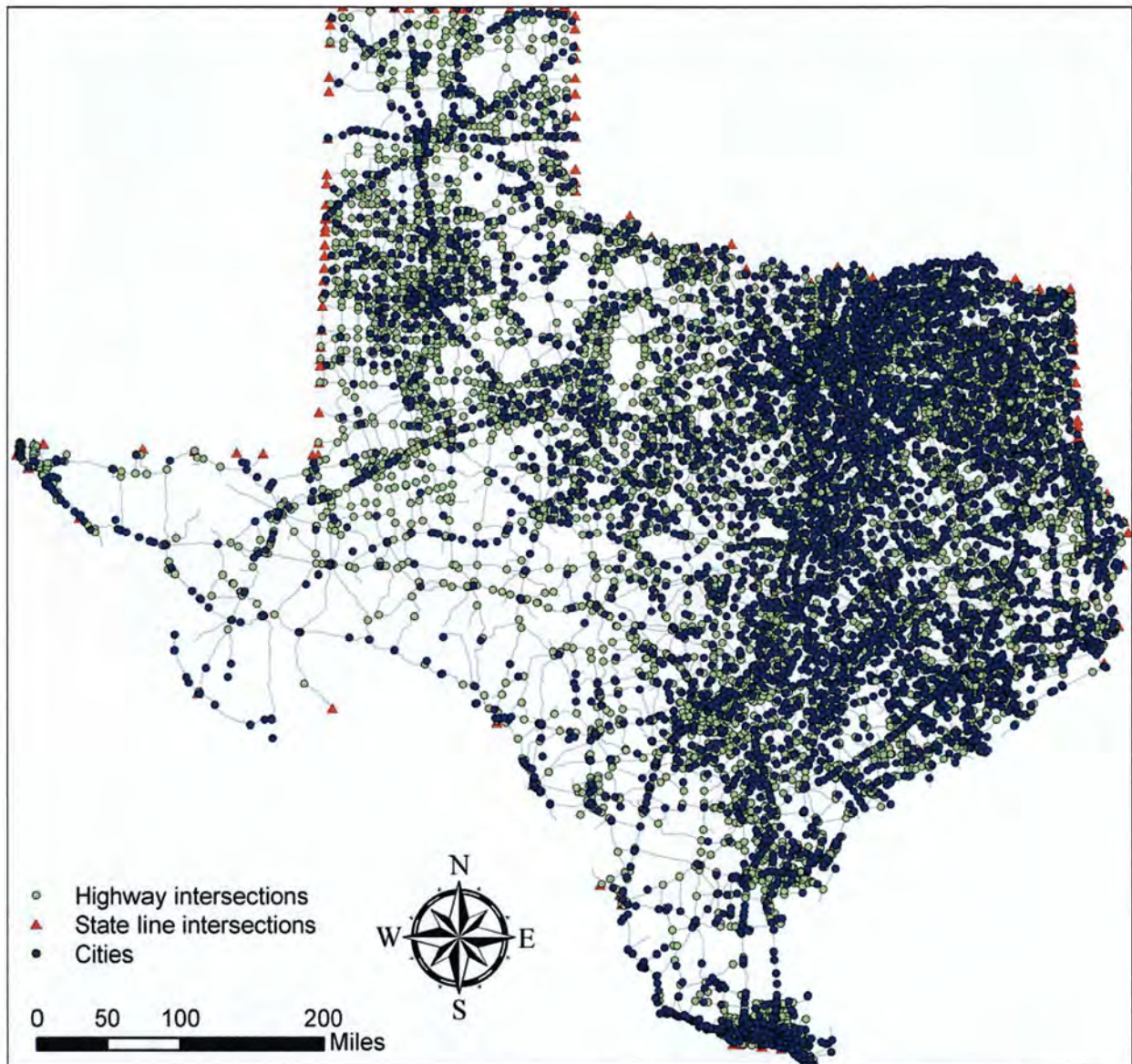

Figure 96. Final Junction Layer for GIS Route Reconstruction.

Generation of Route Shapefiles and Attribution

Additional Route Description Parsing

In previous steps, researchers standardized route descriptions using a syntax that was understandable through programming. In order to create route features using the standardized route descriptions, it was necessary to identify all intersections in the route description and then generate network links between each pair of adjacent intersections. However, the standardized descriptions only listed consecutive highways, not a list of highway intersections. Therefore, researchers converted route descriptions into sequential lists of intersections that could be matched with the junction layer.

An examination of origin, destination, and route descriptions suggested that many permits had identical permit routes. For efficiency, the research team created a separate Oracle table with all unique permit routes for the six study years. Researchers then developed a route description parsing script using C#.NET to extract each of the intersections involved in a permit route sequentially into a new field. The researchers used “~” to separate two highways of an intersection and “;” to separate sequential intersections. At the end of this process, each route description was replaced in the form of a sequential list of intersections. Figure 97 is an example of a route description before and after this parsing, highlighting the changes to the record.

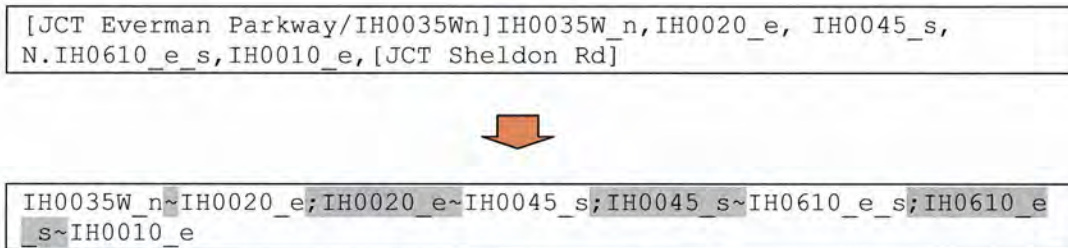

Figure 97. Route Description before and after Intersection Parsing.

GIS Permit Route Reconstruction

The researchers developed an automatic procedure consisting of three VBA programs that closely resembled the route analysis procedure of the ArcGIS Network Analyst. Using three programs that each performed a different processing step enabled the research team to run processes simultaneously on distributed work stations, which greatly improved overall processing speed. For each permit route, the three VBA programs performed the following processes:

- **Generate a point shapefile containing all intersections of the route.** The VBA program completed this step in several stages. First, the program created an empty point shapefile that was used to store the intersection points. The program then read the intersections sequentially into memory from the Oracle database table and matched them with the corresponding point features in the junction layer. Finally, the program extracted the matched points from the junction layer and then appended them into the empty point shapefile. Compared with the following two steps, this step consumed the most processing time and computing resources.
- **Create route segment between each pair of adjacent intersections and store them in a single layer file.** To identify each segment of the permit route, the program read the intersections from the point shapefile that resulted from the previous step and identified the shortest path in distance between each pair of adjacent intersections. In doing so, the program followed the sequence defined in the original route description. Figure 98 shows three alternative paths between two intersections south of Dallas and the shortest path in blue selected by the program. The program then stored each segment as a line feature in a layer file for further processing.

- **Extract route segments from layer file and convert them into a single line feature.**
In the third step, the program combined all the segments of a route into a single line feature and saved the line feature into a separate shapefile.

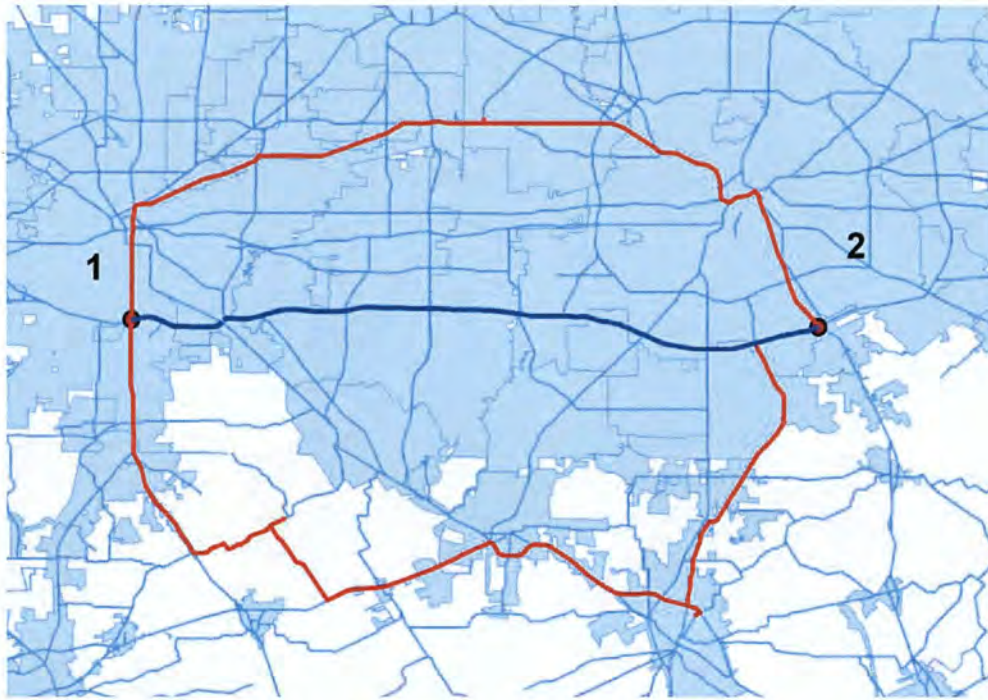

Figure 98. Shortest Path Selection between Two Intersections.

Figure 99 further illustrates the three steps to generate a GIS route feature based on a route description.

When developing the VBA programs for GIS route generation, the research team used several mechanisms that resulted in significant reduction in overall processing time. Particularly worth noting are the direct connection with Oracle database and the enabling of batch processing. A batch is a certain number of permit route records predefined generally based on the length of the permit route description measured in number of characters. Researchers created an index table containing basic batch information, such as batch number, the range of route description length (e.g., 0–50 characters), and the end number of the last record of the batch as it appeared in the Oracle permit route table. The route description length thresholds were designed such that in each batch, the longer the route descriptions, the smaller the number of the records. This mechanism ensured that the times needed for processing different batches were generally balanced. For each program run, the operator entered start and end batch numbers manually.

The use of batches provided maximum flexibility in terms of processing schedule and work station usage. The research team was able to use multiple work stations to process batches. Program parameters were automatically reset after each batch, greatly improving overall computer performance during processing and reducing chances for computing errors.

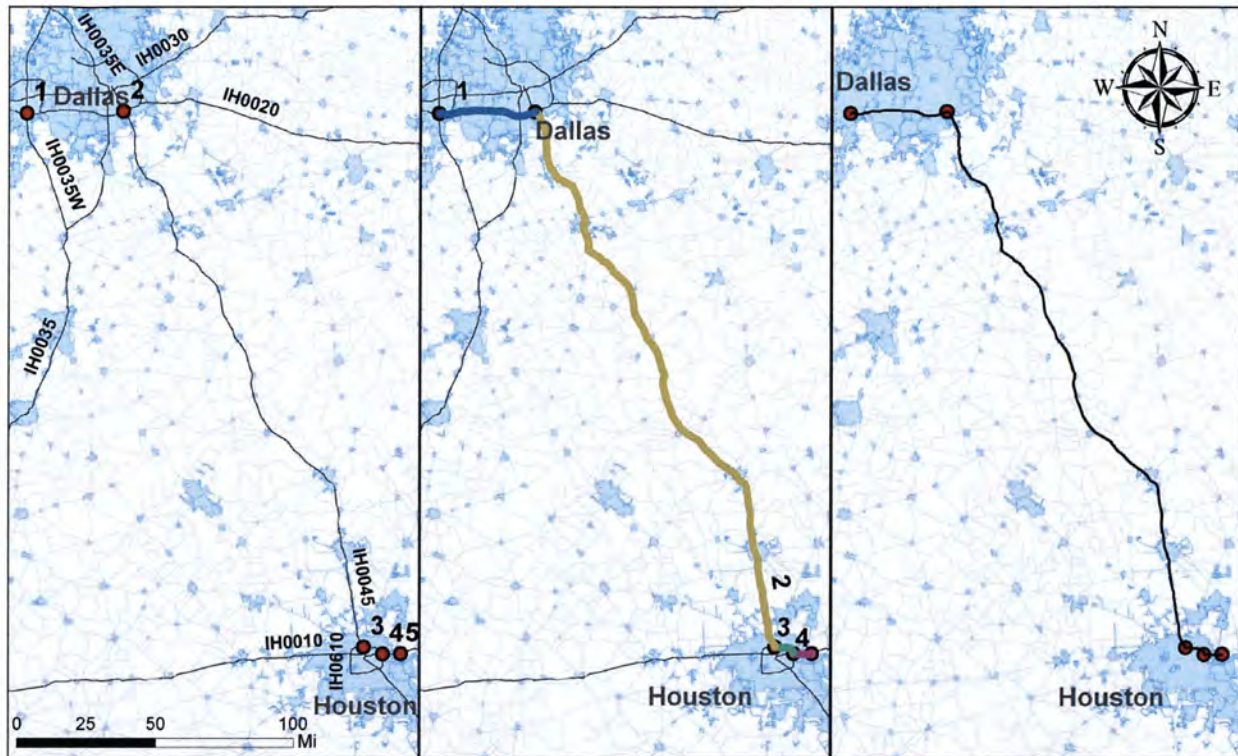

Figure 99. Three Steps of GIS Route Reconstruction (a: Point Shapefile Creation, b: Route Segment Creation, c: Conversion to Single Line Feature).

For efficiency, the research team stored the cleaned route description data in Oracle databases. During the entire GIS route reconstruction process, ArcGIS was able to directly read from and write to the database tables through Microsoft’s Open Database Connectivity (ODBC) technology. ODBC is an interface that enables applications to access external relational databases in an open, vendor-neutral way. ArcGIS supports ODBC data connections through the use of Object Linking and Embedding Database (OLE DB) providers, a tool conforming to the OLE standard used by ESRI products for communicating with and retrieving data from external databases. The use of the Oracle database during processing considerably improved the performance of the route reconstruction process by enabling much more efficient data storage, retrieval, and querying.

Post Processing of Route Shapefiles

The GIS route processing resulted in 590,480 route features, each of which was a separate PolyLine shapefile. During GIS processing, a small number of processed route descriptions were not converted into route features due to a variety of reasons, such as the following:

- **Extremely short routes.** For example, intra-city routes where the on-system portion of the route did not include at least two intersections points.

- **Routes with missing intersections.** A small number of routes had intersections that were not recognized during GIS processing, which resulted in an invalid route error (i.e., an empty line feature class).

To merge the separate shapefiles into line feature classes or a geodatabase, researchers experimented with the “Merge” tool available in ArcGIS Desktop. A few trials indicated that using this tool would be extremely time-consuming due to the large number of shapefiles that needed to be merged. In addition, ArcGIS frequently generated error messages and aborted the merging operations, especially when researchers attempted to simultaneously merge a large group of shapefiles.

To speed up the shapefile merging, the research team used an external program named GeoMerge (1). Unlike the ArcGIS Merge tool, GeoMerge read and output only three files associated with a Shapefile: a .shp file that stores shape type and other geometric data, a .shx file that stores spatial index data, and a .dbf file that stores feature attributes. In addition, the program performed the merging of large number of shapefiles without error.

Using GeoMerge, the research team merged the large number of shapefiles into a few sizeable shapefiles that contained GIS permit routes regardless of permit year. To facilitate GIS route analysis, the researchers imported these shapefiles into a file geodatabase and separated the permit routes into feature classes based on permit year. Table 103 provides a summary of the GIS permit routes processed and stored in the file geodatabase.

Table 103. Summary of Final Processed GIS Permit Routes.

| Fiscal Year | Total Original Permits | Number of Final GIS Routes | Number of Processed Permits | Percent of Total |
|--------------------|-------------------------------|-----------------------------------|------------------------------------|-------------------------|
| 2004 | 444,326 | 99,739 | 225,077 | 50.7% |
| 2005 | 447,876 | 79,723 | 170,464 | 38.1% |
| 2006 | 522,696 | 83,440 | 181,152 | 34.7% |
| 2007 | 554,198 | 86,123 | 186,024 | 33.6% |
| 2008 | 580,410 | 109,051 | 210,776 | 36.3% |
| 2009 | 527,447 | 134,011 | 254,452 | 48.2% |
| Total | 3,076,953 | 592,087 | 1,227,945 | 48.2% |

Because of the large number routes, using the files became somewhat cumbersome: files took a long time to load and draw. To improve usability, researchers split up the files in two or three per year, with a final result of 15 feature classes. Table 104 shows the resulting feature classes as stored in the file geodatabase.

Table 104. File Geodatabase Feature Classes by Fiscal Year

| Fiscal Year | File Name |
|--------------------|------------------|
| 2004 | Route_2004_A |
| | Route_2004_B |
| 2005 | Route_2005_A |
| | Route_2005_B |
| 2006 | Route_2006_A |
| | Route_2006_B |
| 2007 | Route_2007_A |
| | Route_2007_B |
| 2008 | Route_2008_A |
| | Route_2008_B |
| 2009 | Route_2009_A |
| | Route_2009_B |
| | Route_2009_C |

REFERENCES

1. *GeoMerge Geoprocessing Utility*. VDS Technologies, Dover, Delaware, 2011. <http://www.vdstech.com/geomerge.htm>. Accessed August 17, 2011.

APPENDIX C. LETTER TO UTILITY STAKEHOLDERS



October 15, 2009

Re: Evaluation of Overweight Load Routing on Buried Utility Plant, TxDOT Research Project 0-6394

Dear Utility Stakeholder:

The Texas Department of Transportation (TxDOT) is asking for your assistance in identifying locations within state highway right of way with known or suspected risk of damage to buried utility infrastructure. The focus of this research is to identify those locations at risk due to frequency and magnitude of overweight load transport activities (not related to highway construction). This information will be used in a two-year TxDOT sponsored research project entitled, "Evaluation of Overweight Load Routing on Buried Utility Plant" being conducted by the Texas Transportation Institute (TTI), part of the Texas A & M University System. The objectives of the project are to:

- Evaluate the adequacy of the Utility Accommodation Rules (which govern utility installations within state highway right of way) with respect to recent increases in overweight load permitting activity on Texas highways, and
- Develop guidelines for better coordination among TxDOT divisions, regional centers and district offices which seek to minimize impact on buried utility infrastructure.

TTI will evaluate utility damage through forensic field investigation including geotechnical and pavement analysis. For locations within state highway right of way with known or suspected damage to buried utilities possibly caused by overweight load transport activity, please contact TTI with as much of the following information as possible.

- Site Location
 - County
 - Roadway name/designation
 - Location description, nearest intersection, milepoint or coordinates
 - Location relative to roadway (e.g., crossing angle, distance from edge of pavement/ROW line)
- Buried Utility Infrastructure Characteristics
 - Depth
 - Casing/conduit properties (diameter, material, strength/fatigue properties if known)
 - Installation date or approximate age
 - Installation method

THE TEXAS PLAN
REDUCE CONGESTION • ENHANCE SAFETY • EXPAND ECONOMIC OPPORTUNITY • IMPROVE AIR QUALITY
INCREASE THE VALUE OF OUR TRANSPORTATION ASSETS

An Equal Opportunity Employer



October 15, 2009

-Other utility information as available

TTI will consider field evaluations for all sites reported until May 1, 2010. Please email (or mail) information to:

Mr. Edgar Kraus, P.E.
Texas Transportation Institute
1100 NW Loop 410, Ste. 400
San Antonio, TX 78213
e-kraus@tamu.edu

Please include your contact information to allow for follow-up and further coordination if needed. For additional questions, please contact the research project supervisor, Mr. Edgar Kraus at 210.731.9938 or the TxDOT project director, Mr. Randy Anderson at 512.416.2953 or via email at (rande0@dot.state.tx.us). Information submitted to TTI will be handled in strict confidence and will only be used for field evaluations of damage to buried utilities in the context of the research project. Any further dissemination of this outreach to interested stakeholders is encouraged.

The Texas Department of Transportation greatly appreciates your involvement and support of this project as it seeks to better protect the investments made by the ratepayers/taxpayers of this state.

Sincerely,

John P. Campbell, P.E.
Director of Right of Way

THE TEXAS PLAN

REDUCE CONGESTION • ENHANCE SAFETY • EXPAND ECONOMIC OPPORTUNITY • IMPROVE AIR QUALITY
INCREASE THE VALUE OF OUR TRANSPORTATION ASSETS

An Equal Opportunity Employer

**Texas Transportation Institute
The Texas A&M University System
College Station, TX 77843-3135
979-845-1734
<http://tti.tamu.edu>**