

**Southwest Region University Transportation Center**

**Developing Infrastructure for Interconnecting  
Transportation Network and Electric Grid**

SWUTC/11/161006-1

Texas Transportation Institute  
Texas A&M University System  
College Station, Texas 77843-3135





1. Report No. <b>SWUTC/11/161006-1</b>		2. Government Accession No.		3. Recipient's Catalog No.	
4. Title and Subtitle <b>Developing Infrastructure for Interconnecting Transportation Network and Electric Grid</b>				5. Report Date <b>September 2011</b>	
				6. Performing Organization Code	
7. Author(s) <b>Seok Kim and Ivan Damnjanovic</b>				8. Performing Organization Report No. <b>Report 161006-1</b>	
9. Performing Organization Name and Address <b>Texas Transportation Institute Texas A&amp;M University System College Station, Texas 77843-3135</b>				10. Work Unit No. (TRAIS)	
				11. Contract or Grant No. <b>10727</b>	
12. Sponsoring Agency Name and Address <b>Southwest Region University Transportation Center Texas Transportation Institute Texas A&amp;M University System College Station, Texas 77843-3135</b>				13. Type of Report and Period Covered <b>Research Report</b>	
				14. Sponsoring Agency Code	
15. Supplementary Notes <b>Supported by general revenues from the State of Texas.</b>					
16. Abstract <b>This report is primarily focused on the development of mathematical models that can be used to support decisions regarding a charging station location and installation problem. The major parts of developing the models included identification of the problem, development of mathematical models in the form of bilevel and stochastic programming problems, and development of a solution approach using a meta-heuristic method. PEV parking building problem was formulated as a bilevel programming problem in order to consider interaction between transportation flow and a manager decisions, while the charging station installation problem was formulated as a stochastic programming problem in order to consider uncertainty in parameters. In order to find the best-quality solution, a genetic algorithm method was used because the formulation problems are NP-hard. In addition, the Monte Carlo bounding method was used to solve the stochastic program with continuous distributions. The results of this study provide managerial implications for developers and operators of parking building.</b>					
17. Key Words <b>PEV, Parking Building, Charging Station, Decision-Support Model, Transportation Network, Electric Power Network</b>			18. Distribution Statement <b>No restrictions. This document is available to the public through NTIS: National Technical Information Service 5285 Port Royal Road Springfield, Virginia 22161</b>		
19. Security Classif.(of this report) <b>Unclassified</b>		20. Security Classif.(of this page) <b>Unclassified</b>		21. No. of Pages <b>121</b>	22. Price



# **Developing Infrastructure for Interconnecting Transportation Network and Electric Grid**

Seok Kim  
Graduate Student Assistant  
Department of Civil Engineering  
Texas A&M University System

Ivan Damnjanovic (Ph.D)  
Assistant Professor  
Department of Civil Engineering  
Texas A&M University System

**Research Report SWUTC/11/161006-1**

Southwest Region University Transportation Center  
Texas Transportation Institute  
Texas A&M University System  
College Station, Texas 77843-3135

September 2011



## ABSTRACT

This report formulates and develops models and solution approaches for plug-in electric vehicle (PEV) charging station installation. The models are formulated in the form of bilevel programming and stochastic programming problems, while a meta-heuristic method, genetic algorithm, and Monte Carlo bounding techniques are used to solve the problems.

Demand for PEVs is increasing with the growing concerns about environment pollution, energy resources, and the economy. However, battery capacity in PEVs is still limited and represents one of the key barriers to a more widespread adoption of PEVs. It is expected that drivers who have long-distance commutes hesitate to replace their internal combustion engine vehicles with PEVs due to range anxiety. To address this concern, PEV infrastructure can be developed to provide re-fully status when they are needed.

This report is primarily focused on the development of mathematical models that can be used to support decisions regarding a charging station location and installation problem. The major parts of developing the models included identification of the problem, development of mathematical models in the form of bilevel and stochastic programming problems, and development of a solution approach using a meta-heuristic method.

PEV parking building problem was formulated as a bilevel programming problem in order to consider interaction between transportation flow and a manager decisions, while the charging station installation problem was formulated as a stochastic programming problem in order to consider uncertainty in parameters. In order to find the best-quality solution, a genetic algorithm method was used because the formulation problems are NP-hard. In addition, the Monte Carlo bounding method was used to solve the stochastic program with continuous distributions.

## **DISCLAIMER**

The contents of this report reflect the views of the authors, who are responsible for the facts and the accuracy of the information presented herein. This document is disseminated under the sponsorship of the Department of Transportation, University Transportation Centers Program, in the interest of information exchange. Mention of trade names or commercial products does not constitute endorsement or recommendation for use.



## **ACKNOWLEDGMENT**

The authors recognize that support for this research was provided by a grant from the U.S. Department of Transportation, University Transportation Centers Program to the Southwest Region University Transportation Center which is funded, in part, with general revenue funds from the State of Texas.



## EXECUTIVE SUMMARY

Plug-in electric vehicles (PEVs), either as battery electric vehicles (BEVs) or plug-in hybrid electric vehicles (PHEVs), have gained much attention as an effective solution to growing concerns about energy security and environmental pollution. The market for PEVs has been steadily growing. Recently, rising gas prices have made drivers consider a PEV as their next vehicle. Furthermore, federal and local governments are now providing incentives for consumers to increase PEV sales, including carpool lane access, rebates, and tax credits.

The unique feature of PEVs—a connection to an electric power grid using a plug—could bring significant benefits to electric power systems. Generally, when electric power stored in PEVs flows to a power grid, it is called “vehicle-to-grid” (V2G). The opposite flow of electric power is referred to as “grid-to-vehicle” (G2V). PEV infrastructure with the V2G mode has potential to develop a new business model for vehicle charging. PEV parking garage could provide ancillary services of regulation, spinning reserve, and peak power in the V2G mode as a business model. PEV infrastructure with the G2V mode would accelerate the increased PEV adoption rate. Drivers who have long-distance commutes hesitate to replace their ICEVs with PEVs due to range anxiety. In this situation, PEV infrastructure could encourage people to replace their ICEVs with PEVs.

Unlike conventional parking buildings, PEV parking buildings can provide charging services to users and contract with an independent system operator (ISO) to service the grid and make a profit. The PEV parking building problem in this study was formulated to determine the optimal location and (dis)incentive structure on a pre-specified link. Therefore, the PEV infrastructure development problem was formulated in the form of a bilevel programming problem (BLPP). The traffic assignment problem is defined as a lower-level problem and the business model as an upper-level problem. The traffic assignment problem requires data and parameters, such as traffic counts, parking hours, and network properties. The results of the traffic assignment problem, link flows between nodes, were used to calculate the demand for a PEV parking building. The business model consists of services provided by a PEV parking building: parking, charging, regulation, and peak demand service. In addition, the business model requires electric power price data and plausible PEV adoption rates.

A PEV parking building can be considered as a power generation source, or power load in an electric power network. Hence, PEV parking demand can change the electric load on buses. Impact model investigates the impact of PEVs on traffic flow and micro-level power system configurations, such as a nodal area, from a parking garage developer’s perspective. The model developed in this study employs data such as trip rates and power system operating conditions to calculate PEV parking demand and locational marginal prices on buses, which can explain the impact of a PEV infrastructure on transportation network and electric power network. The locational marginal prices are used in the business model.

Installation of charging stations could affect drivers' parking choices. Parking building with charging stations could encourage people to replace their ICEVs with PEVs as they could charge the batteries while parked. PEV charging station installation model can help operators make better decisions such as how many charging stations to install. In this study, a stochastic model was formulated in the form of a two-stage stochastic problem with simple recourse and full recourse. The PEV charging station installation problem was formulated in the form of a stochastic programming problem (SPP). In this study, two types of SPPs were designed: a two-stage simple recourse, and a two-stage recourse problem. Two-stage simple recourse model focuses on the first stage decisions and the consequence in the others. On the other hand, two-stage recourse problem considers that the initial decision will affect the decision in the second stage. To calculate PEV parking demand, data such as parking demand, PEV penetration rate, and rate of willingness to charge are required. The total cost is the sum of installation cost and utility cost calculated from the PEV parking demand. The PEV charging station installation problem determines the number of charging stations that constitute the optimal decision variables.

Managerial implications and recommendations for PEV parking building developers and managers were suggested in terms of sensitivity analysis. First, in the planning stage, the developer of the PEV parking building should consider long-term changes in future traffic flow and locate a PEV parking building closer to the node with the highest destination trip rate. Second, to attract more parking users, the operator needs to consider the walkability of walking links. Third, the operator of the PEV parking building can control the demand of the PEV parking building by manipulating the incentive structure (parking fee). In addition, from PEV charging station problem, the parking facility operator should focus more on forecasting the mean values of the two random variables (PEV penetration rate and rate of willingness to charge) at the planning stage. These are critical values in determining the total cost and the number of charging stations. Second, in order to reduce the total cost, it is recommended that managers reduce the utility cost and unit installation cost. Unlike the uncertain rates, these two costs may be manipulated by the parking operator based on policies to encourage the use of PEVs.

# TABLE OF CONTENTS

ABSTRACT .....	v
DISCLAIMER.....	vi
ACKNOWLEDGEMENTS.....	vii
EXECUTIVE SUMMARY .....	ix
TABLE OF CONTENTS .....	xi
LIST OF FIGURES.....	xii
LIST OF TABLES.....	xv
1. INTRODUCTION .....	1
1.1 Background and Research Motivation .....	1
1.2 Research Objectives .....	2
1.3 Scope of the Study .....	3
1.4 Overview of Study Approach.....	3
1.4.1 PEV Infrastructure Development Problem.....	4
1.4.2 Model for Impact of PEV Infrastructure .....	4
1.4.3 PEV Charging Station Installation Problem.....	5
1.4.4 Solution Approaches .....	5
1.5 Dissertation Outline .....	5
2. LITERATURE REVIEW.....	7
2.1 Facility Location Problem.....	7
2.2 Traffic Assignment.....	8
2.3 Parking Choice Model.....	10
2.4 Network Design Problem .....	11
2.5 Stochastic Programming .....	11
2.6 Electricity Power Market .....	12
2.7 Economic Dispatch and Locational Marginal Price.....	14
2.8 Summary .....	15
3. PEV PARKING BUILDING DEVELOPMENT PROBLEM .....	17
3.1 Problem Description.....	17
3.2 The Model .....	19
3.2.1 Lower-Level Problem.....	23
3.2.2 Upper-Level Problem.....	26
3.3 Computational Study.....	27
3.3.1 Simple Network.....	27
3.3.2 Large Network.....	34
3.4 Summary .....	37

4. IMPACT OF PEV ON ELECTRICITY NETWORK.....	39
4.1 Problem Description.....	39
4.2 The Model.....	41
4.2.1 Network Design Problem.....	41
4.2.2 Power System Operating Conditions .....	42
4.3 Computational Study.....	43
4.3.1 Simple Network.....	43
4.3.2 Large Network.....	52
4.4 Summary .....	63
5. CHARGING STATION INSTALLATION PROBLEM (TWO-STAGE STOCHASTIC PROBLEM WITH SIMPLE RECOURSE) .....	65
5.1 Problem Description.....	65
5.2 The Model.....	67
5.3 Monte Carlo Bounding Approach.....	69
5.4 Case Study.....	70
5.4.1 Area Scope .....	70
5.4.2 Data .....	73
5.4.3 Results .....	76
5.4.4 Sensitivity Analysis.....	76
5.5 Summary .....	78
6. CHARGING STATION INSTALLATION PROBLEM WITH DECISION-DEPENDENT ASSESSMENT OF UNCERTAINTY (TWO-STAGE STOCHASTIC PROBLEM WITH RECOURSE).....	79
6.1 Problem Description.....	79
6.2 The Model.....	81
6.3 Decision-Dependent Assessment of Uncertainty.....	82
6.4 Case Study.....	85
6.5 Summary .....	87
7. SUMMARY AND CONCLUSIONS.....	89
7.1 Overall Summary and Discussion.....	89
7.2 Recommendations for Future Research .....	91
REFERENCES .....	93
APPENDIX A.....	101
APPENDIX B.....	102
APPENDIX C.....	103
APPENDIX D.....	104
APPENDIX E.....	105

## LIST OF FIGURES

Figure 1.1 Overall Study Approach.....	4
Figure 2.1 Power Market Structure.....	13
Figure 3.1 Roles of PEV Parking Building.....	17
Figure 3.2 Simple Transportation Network with PEV Parking Building .....	18
Figure 3.3 Example of Demand of PEV Parking Building for One Day.....	19
Figure 3.4 Simple Network.....	28
Figure 3.5 Demands of PEV Parking Building Depending on Location and Incentive	31
Figure 3.6 Fitness and Contour Graph for Total Revenue .....	33
Figure 3.7 Results of Sensitivity Analysis.....	34
Figure 3.8 Sioux Falls Network.....	35
Figure 3.9 Fitness Graph for Total Revenue.....	36
Figure 3.10 Results of Sensitivity Analysis.....	37
Figure 4.1 Schematic Representation of the Networks with PEV Parking Building.....	40
Figure 4.2 Example Networks .....	44
Figure 4.3 Power Load in V2G.....	46
Figure 4.4 Power Generation in V2G .....	47
Figure 4.5 LMP in V2G.....	48
Figure 4.6 Power Load in G2V.....	49
Figure 4.7 Power Generation in G2V .....	50
Figure 4.8 LMP in G2V .....	51
Figure 4.9 Surface and Contour Graphs for Total Revenues.....	52
Figure 4.10 IEEE 14 Bus Test System on Transportation Network in Sioux Falls .....	53
Figure 4.11 Operating Areas for Each Bus.....	54
Figure 4.12 Limits of Operating Areas in Transportation Network .....	55
Figure 4.13 Fitness Graph for Total Revenue.....	57
Figure 4.14 Power Load in V2G of Large Network .....	58
Figure 4.15 Power Generation in V2G of Large Network.....	59
Figure 4.16 LMP in V2G of Large Network .....	60
Figure 4.17 Power Load in G2V of Large Network .....	61
Figure 4.18 Power Generation in G2V of Large Network.....	62
Figure 4.19 LMP in G2V of Large Network .....	63
Figure 5.1 Influence of Installation of Charging Stations.....	65
Figure 5.2 Model Framework .....	66
Figure 5.3 Existing Parking Garages and Surface Parking Lots.....	71
Figure 5.4 Installation Cost.....	73
Figure 5.5 Utility Cost .....	74
Figure 5.6 Attraction Rate by Walking Distance.....	75
Figure 5.7 Distributions for Uncertain Parameter.....	75
Figure 5.8 Results of Sensitivity Analysis.....	77
Figure 6.1 Model Framework .....	80
Figure 6.2 Procedure of Bayesian Updating.....	84

Figure 6.3 Fitness Graph for Total Cost ..... 86



## LIST OF TABLES

Table 3.1	Link Data for Example Network .....	28
Table 3.2	Forecasts of Power Price Used for Numerical Example .....	29
Table 3.3	Methods and Parameters of GA Operators.....	32
Table 4.1	Generation Data for Example Network.....	44
Table 4.2	Modified Generator Data.....	55
Table 4.3	Modified Branch Data .....	56
Table 4.4	Modified Generator Cost Data .....	57
Table 5.1	Equations for Monte Carlo Bounding Method.....	70
Table 5.2	Parking Spaces .....	71
Table 5.3	Walking Distances from Northgate Garage .....	72
Table 5.4	Result.....	76
Table 6.1	Methods and Parameters of GA Operators.....	85
Table 6.2	Result.....	87



# 1. INTRODUCTION

## *1.1 Background and Research Motivation*

Plug-in electric vehicles (PEVs), either as battery electric vehicles (BEVs) or plug-in hybrid electric vehicles (PHEVs), have gained much attention as an effective solution to growing concerns about energy security and environmental pollution. Currently, the transportation sector accounts for more than half of the total liquid fuel demand (EIA 2009) and produces the highest amount of CO<sub>2</sub> emissions in the US—around 33% (Lilienthal and Brown 2007). PEVs represent solution to these concerns in that they provide higher fuel efficiency and lower greenhouse gas (GHG) emissions than internal combustion engine vehicles (ICEVs).

The market for PEVs has been steadily growing. Recently, rising gas prices have made drivers consider a PEV as their next vehicle. Furthermore, federal and local governments are now providing incentives for consumers to increase PEV sales, including carpool lane access, rebates, and tax credits. Growing PEV demand also encourages major automobile manufacturers to develop PEV models. Several researchers have recently stated that the market share of PEVs will significantly increase in the future. For example, Sort and Denholm (2006) estimated that by 2030, the market share of PEVs could reach 25%, and a technical report from the University of Michigan (Sullivan et al. 2009) predicts that the market share of PHEVs could reach around 20% by 2040, in an optimistic scenario.

The unique feature of PEVs—a connection to an electric power grid using a plug—could bring significant benefits to electric power systems. Generally, when electric power stored in PEVs flows to a power grid, it is called “vehicle-to-grid” (V2G). The opposite flow of electric power is referred to as “grid-to-vehicle” (G2V). The generating potential of V2G technology could be substantial. For instance, 150 PHEVs, such as PHEV-40 or PHEV-60, which stand for a plug-in hybrid electric vehicle with 40 miles or 60 miles of electric only range, could provide 1 MW of power for several hours, which is enough to support a large building (Solomon and Vincent 2003). Also, if all light vehicle fleets in the United States connected to a power grid, the generated power would be around seven times larger than the average national load (Kempton and Dhanju 2006). PEVs connected to a power grid could perform the role of a distributed generator, which in turn could provide several advantages: improving efficiency of power generation, making power grids more stable, and reducing the losses from transmission and distribution systems (Stovall et al. 2005).

Further, PEVs play an important synergetic role in wind generation, thereby helping with the difficulty in managing such sources of energy. Wind energy has been regarded as one of the most powerful and renewable sources of energy. However, wind energy has a reliability problem in that the production of electricity does not remain consistent. As a solution for managing the supply of wind energy, Kempton and Tomic (2005b) suggested that the V2G technology of PEVs can provide operating reserves and storage to control the volatility of wind energy as well as that of other renewable energy sources.

PEV infrastructure with the V2G mode has potential to develop a new business model for vehicle charging. For example, Kempton and Tomic (2005a; 2005b) suggested a PEV parking garage that could provide ancillary services of regulation, spinning reserve, and peak power in the V2G mode as a business model. Similarly, Guille and Gross (2009) proposed a framework to integrate the aggregated battery vehicles into the electric power grid and presented the aggregated PEVs in a parking facility as one of the electric power sources.

PEV infrastructure with the G2V mode would accelerate the increased PEV adoption rate. Battery capacity in PEVs is one of the key barriers in the more widespread adoption of PEV. Drivers who have long-distance commutes hesitate to replace their ICEVs with PEVs due to range anxiety. In this situation, PEV infrastructure could encourage people to replace their ICEVs with PEVs.

This research was motivated by the lack of advances in development of PEV infrastructures. A PEV infrastructure represents an interface between a transportation network and an electric power system. Developers of PEV infrastructures need to carefully consider two different networks and systems at the construction planning stage. However, little attention has been paid to the development of new PEV infrastructures by concurrently considering behavior of two different networks and systems (i.e. transportation and electric power flow).

Making sound decisions based on accurate estimates of cost and future revenue, which occurs in the planning stage, is important for developing a new infrastructure that is effective and beneficial to project developers. This study provides a basis for: a) developing new parking infrastructures, and b) investigating the impact of those new parking infrastructures on transportation and electric power system. The analyses are limited to planning stage of project development.

The methodology developed through this research involves the integration of two different networks and systems and a solution framework based on a genetic algorithm and the Monte Carlo bounding technique.

## ***1.2 Research Objectives***

The main goal of this research is to develop strategic decision-support models for PEV infrastructure development from a business proposition perspective, and to investigate the impact of PEV infrastructures on the electric power market and transportation system performance. The strategic decision models were created for project developers or facility managers. More specifically, the research objectives and issues are as follows:

- Objective 1: Formulate a deterministic PEV infrastructure development problem that can be used to make optimal decisions based on current traffic and power system conditions. The PEV infrastructure location problem should be able to take into account sensitivity of transportation network structure, origin-destination trip rates, parking fee, and electric power price on profitability of the project.

- Objective 2: Formulate a stochastic PEV charging station installation problem that can be used to determine the optimal number of charging stations to be installed in existing parking buildings. The problem considers uncertainty on PEV adoption rates, cost of installation, and opportunity cost of converting existing parking spots that currently guarantee certain revenue.
- Objective 3: Design meta-heuristic algorithms that can exploit problem structure in solving the proposed problems (both small scale and large scale networks) within a reasonable run time.
- Objective 4: Develop a model to investigate the impact of PEV infrastructures on transportation networks and electric power systems. This is an inverse problem of the problem in objective 1 where the focus is on private development. The model should be able to provide optimal decisions depending on different conditions, such as V2G with fixed power price, V2G with locational marginal prices, and G2V with locational marginal prices.

### ***1.3 Scope of the Study***

The scope of the study is as follows:

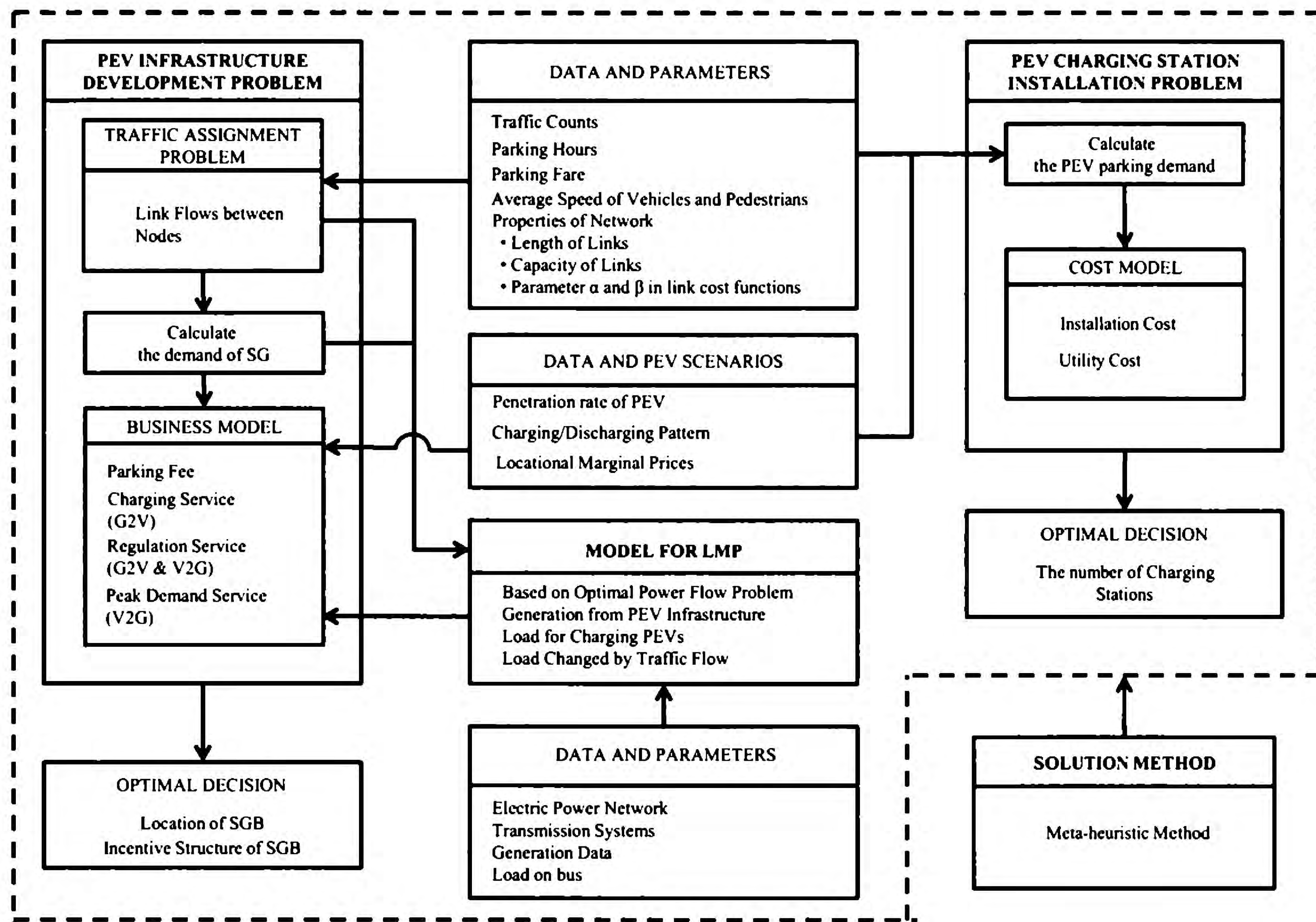
- The present study focuses on identifying optimal decisions for developing a PEV infrastructure project and the impact of a PEV parking building on the electric power market and transportation system.
- The proposed problems were developed from the perspective of PEV infrastructure developers and managers. Note that developers and managers can make optimal decisions in order to increase their profit and decrease their cost.
- The proposed problems are considered in project planning stage. The decisions such as facility location, incentive structure, and the number of charging stations, are usually made during the planning stage.
- A PEV infrastructure serves as a parking facility and an electric aggregator<sup>1</sup>. PEV developers and managers can make a profit from providing parking service and charging service, as well as contracting with an independent system operator (ISO) to sell electric power generated from vehicle batteries.

### ***1.4 Overview of Study Approach***

The research study described in this report was carried out in four parts, as shown in Figure 1.1. Details of the framework for each part of the study are provided in the following sections.

---

<sup>1</sup> A person or company that gathers together electric customers for the purpose of negotiating the purchase of electric generation services from an electric supplier (Fell et al. 2010).



**Figure 1.1 Overall Study Approach**

#### 1.4.1 PEV Infrastructure Development Problem

The PEV infrastructure development problem was formulated in the form of a bilevel programming problem (BLPP). The traffic assignment problem is defined as a lower-level problem and the business model as an upper-level problem. The traffic assignment problem requires data and parameters, such as traffic counts, parking hours, and network properties. The results of the traffic assignment problem, link flows between nodes, were used to calculate the demand for a PEV parking building. The business model consists of services provided by a PEV parking building: parking, charging, regulation, and peak demand service. In addition, the business model requires electric power price data and plausible PEV adoption rates.

#### 1.4.2 Model for Impact of PEV Infrastructure

A PEV parking building can be considered as a power generation source, or power load in an electric power network. Hence, PEV parking demand can change the electric load on buses. The model developed in this study employs data such as trip rates and power system operating conditions to calculate PEV parking demand and locational marginal prices on buses, which can explain the impact of a PEV infrastructure on transportation network and electric power network. The locational marginal prices are used in the business model.

### *1.4.3 PEV Charging Station Installation Problem*

The PEV charging station installation problem was formulated in the form of a stochastic programming problem (SPP). In this study, two types of SPPs were designed: a two-stage simple recourse, and a two-stage recourse problem. Two-stage simple recourse model focuses on the first stage decisions and the consequence in the others. On the other hand, two-stage recourse problem considers that the initial decision will affect the decision in the second stage. To calculate PEV parking demand, data such as parking demand, PEV penetration rate, and rate of willingness to charge are required. The total cost is the sum of installation cost and utility cost calculated from the PEV parking demand. The PEV charging station installation problem determines the number of charging stations that constitute the optimal decision variables.

### *1.4.4 Solution Approaches*

As it is very difficult to solve bilevel programming problems and stochastic programs with continuous distributions, a meta-heuristic method was used in this study to find the high-quality, optimal solution. Among meta-heuristic methods, the genetic algorithm is a general method for searching the feasible landscape for highly fit solutions. The genetic algorithm consists of three types of operators, including selection, cross-over, and mutation.

Finally, a sensitivity analysis revealed some managerial implications for the proposed problems in this study. Generally, sensitivity analysis provides a measure of how the optimal decisions vary with the changes in the parameters and scenarios.

## *1.5 Report Outline*

This report is organized in seven chapters.

- Chapter 1 reveals the background and research motivation, including the study objectives, scope, and approach, and provides an outline of the research.
- Chapter 2 reviews the conventional facility location problem, network design problem, stochastic programming problem, and other related research efforts in the electricity power market.
- Chapter 3 describes the proposed model for developing a new PEV parking building. In the model, interaction between a transportation network and an electric power system is formulated in terms of a bilevel programming problem. For a developer, managerial implications are suggested based on a sensitivity analysis.
- Chapter 4 focuses on an investigation of the impact of a PEV parking building on an electric power system. To look into the impact, this study considered locational marginal prices by integrating the PEV parking building problem in Chapter 3 and a power flow analysis.

- Chapter 5 presents a model for installing charging stations in an existing parking building. The model was formulated in the form of the stochastic programming problem in order to consider uncertainty in parameters.
- Chapter 6 describes an improvement of the model in Chapter 5, in order to explain the influence of the initial decision on uncertainty in parameters. The framework of Bayesian updating of random parameters is described. The model gives the best combination of two decisions: the number of initial charging stations in the first stage and that of additional charging stations in the second stage.
- Chapter 7 discusses the achievement of research goals, contributions, and limitations of developed problems. In addition, future research endeavors are recommended.



## 2. LITERATURE REVIEW

This chapter presents an overview of the background literature on conventional facility location problems, traffic assignment problem, parking choice model, network design problems, stochastic programming problems, and other related research efforts on modeling the electricity power market and price. Section 2.1 introduces a general background of facility location problems and reviews continuous single facility location problems. In Section 2.2, traffic assignment problem is introduced in terms of driver's behavior assumptions and time-dependency. Section 2.3 shows some parking choice models and important factors for the models. In Section 2.4, a brief review of network design problems and some applications are presented. Section 2.5 introduces a basic formulations of a stochastic programming problem and presents some application areas of the modeling formulations. Section 2.6 presents the power market analysis and structure. Some basic equations to calculate economic generation plan and regional electric power prices are shown in Section 2.7.

### 2.1 Facility Location Problems

Facility location problems can be used to determine the optimal location of industrial or governmental buildings. Location decision has been shown to have an influence on service cost and quality and is generally applied to hospital, warehouse, and plant location problems. Location problems are classified as discrete and continuous facility location problems. This section presents a brief background of continuous facility location problems.

Since Alfred Weber (1909) first introduced the concept of finding optimal location, location problems have been extensively used for determining facility location, fire-station coverage, and in-network design problems. The objective of the Weber problem, also known as the 1-median problem, is to find the location of a facility by minimizing the sum of the weighted distances and is formulated as follows:

$$\min f(x) = \sum_{i=1}^n w_i \rho(x - x_i) \quad (2.1)$$

where,  $x$  is the location of the new facility;  $x_i$  is the location of the existing facility;  $\rho(x - x_i)$  is the function of the distance between  $x$  and  $x_i$ ;  $w_i$  is the parameter used to convert the distance to cost; and  $n$  is the number of existing facilities.

In a continuous facility location problem, every point on a line, plane, or space represents a feasible location for a facility. Continuous single facility location problems (CSFLPs) have been extensively studied (Cooper 1963; Goldman 1971; Plastria 1987). Plastria (1987) formulated a CSFLP and provided a solution based on the cutting plane algorithm. A continuous facility location problem has several basic assumptions: (a) travel demands and supplies are known; (b) transportation costs are proportional to distance; and (c) distance is derived from Euclidean distance.

In order to decide the location of PEV parking building, the models in this report are formulated in the form of CSFLP. Therefore, the decision variable for parking building location will be defined as a positive real number.

## 2.2 Traffic Assignment

Traffic assignment problem is closely related to the routing choice problem in transportation network, and can be approached as either user equilibrium (UE) and system optimal (SO) traffic assignment in the terms of driver behavior as assumptions. In UE traffic assignment, all drivers choose their routes to minimize their own travel time. Here, the equilibrium means no driver can find a lower transportation cost by changing his or her route choice. Beckmann (1956) first formulated the UE flow pattern as follows:

$$\min_x \sum_a \int_0^{f_a} C_a(x) dx \quad (2.2)$$

$$s.t. \quad \sum_p X_{ijp} = T_{ij} \quad (2.3)$$

$$X_{ijp} \geq 0 \quad (2.4)$$

$$f_a = \sum_i \sum_j \sum_p X_{ijp} \delta_{ijp}^a \quad \forall a \quad (2.5)$$

where,  $f_a$  is the flow on link  $a$ ;  $T_{ij}$  is the flow from  $i$  to  $j$ ;  $X_{ijp}$  is the flow on path  $p$  from  $i$  to  $j$ ;  $C_a(x)$  is the average travel cost function for link  $a$ ; and  $\delta_{ijp}^a$  is 1, if link  $a$  is on path  $p$  from  $i$  to  $j$ , 0 otherwise.

In SO traffic assignment, all drivers choose their routes to minimize some global cost, e.g. the sum of all travel time. Comparing to the UE formulation, the SO formulation of traffic assignment has a different objective function, but includes same constraints in Equation 2.3 through 2.5. The objective function of SO traffic assignment is defined as the sum of travel costs as follows (LeBlanc 1975):

$$\min \sum_a f_a C_a(f_a) \quad (2.6)$$

Further, traffic assignment problems also can be divided into static traffic assignment (STA) and dynamic traffic assignment (DTA) problem in the terms of time independence of origin-

destination matrix and link flows. STA problem explains O-D traffic flow based on the assumption that traffic flow on transportation network is static.

Unlike STA problem, DTA problem considers time-varying traffic flow. DTA problem can be generally classified as either analytical or simulation-based approach techniques. The analytical approach is formulated using mathematical programming, variational inequality formulations, and optimal control. Among many analytical approaches, cell transmission traffic flow model (Ziliaskopoulos 2000) is formulated as below. The notation used in the model is shown in APPENDIX A.

$$\min \sum_{\forall i \in T} \sum_{\forall i \in C \setminus C_S} x_i^t \quad (2.7)$$

*s.t.*

$$x_i^t - x_i^{t-1} - \sum_{k \in \Gamma^{-1}(i)} y_{ki}^{t-1} + \sum_{j \in \Gamma(i)} y_{ij}^{t-1} = 0 \quad \forall i \in C \setminus \{C_R, C_S\}, \forall t \in T \quad (2.8)$$

$$y_{ij}^t - x_i^t \leq 0, y_{ij}^t \leq Q_j, y_{ij}^t \leq Q_i, y_{ij}^t + \delta_j x_j^t \leq \delta_j N_j^t, \forall (i, j) \in E_O \cup E_R, \forall t \in T \quad (2.9)$$

$$y_{ij}^t - x_i^t \leq 0, y_{ij}^t \leq Q_i, \quad \forall (i, j) \in E_S, \forall t \in T \quad (2.10)$$

$$y_{ij}^t \leq Q_j, y_{ij}^t + \delta_j x_j^t \leq \delta_j N_j^t, \quad \forall (i, j) \in E_D, \forall t \in T \quad (2.11)$$

$$\sum_{\forall j \in \Gamma(i)} y_{ij}^t - x_i^t \leq 0, \sum_{\forall j \in \Gamma(i)} y_{ij}^t \leq Q_i, \quad \forall i \in C_D, \forall t \in T \quad (2.12)$$

$$y_{ij}^t - x_i^t \leq 0, y_{ij}^t \leq Q_i, \quad \forall (i, j) \in E_M, \forall t \in T \quad (2.13)$$

$$\sum_{\forall i \in \Gamma^{-1}(j)} y_{ij}^t \leq Q_j, \sum_{\forall i \in \Gamma^{-1}(j)} y_{ij}^t + \delta_j x_j^t \leq \delta_j N_j^t, \quad \forall j \in C_M, \forall t \in T \quad (2.14)$$

$$x_i^t - x_i^{t-1} + y_{ij}^{t-1} = d_i^{t-1}, \quad j \in \Gamma(i), \forall i \in C_R, \forall t \in T, x_i^0 = \zeta_i, \forall i \in C \quad (2.15)$$

$$y_{ij}^0 = 0 \quad \forall (i, j) \in E \quad (2.16)$$

$$x_i' \geq 0 \quad \forall i \in C, \forall t \in T \quad (2.17)$$

$$y_{ij}' \geq 0, \quad \forall (i, j) \in E, \forall t \in T \quad (2.18)$$

In order to evaluate PEV parking demand in this report, drivers' routing choice needs to be determined. In this report, UE-STA problem is used, and as such represents lower level problem in the network design problem.

### 2.3 Parking Choice Model

Early studies of drivers' parking choices have investigated the effect of various factors on the propensity to park at specific location. Parking choice models, developed based on survey data, include works by Ergün (1971) that formulated a set of a logit models based on a survey of commuters' parking behavior in 1969. Hunt (1988) developed hierarchical logit models which can describe the choice of parking location and type. Lambe (1996) formulated a parking choice model in the form of a logit model and proposed that walking distance and parking fee are important in choosing parking locations. Tatsumi (2003) presented a multinomial logit model which considered walking distance, parking price, parking lot capacity, driving time, and parking guidance and information as explanatory variables.

Recently, parking choice models have been developed based on network formulations. Tong et al. (2004) presented a parking choice model by adopting a user equilibrium network assignment. Parking cost function was formulated with walking distance, hourly parking cost, parking duration, and parking space searching cost, which was included in the objective function. The parking cost is formulated as follows:

$$u_{cjp} = \gamma_c^f \tau_p(f) + \gamma_c^s s_{jp} + \theta_c d_{cp} h_p \quad \forall c \in C, \forall j \in J, \forall p \in P \quad (2.19)$$

where  $\gamma_c^f$  and  $\gamma_c^s$  are the unit cost for searching a parking space and walking for commodity  $c$ .  $\tau_p(f)$  is the search time for a parking space at parking facility  $p$ .  $s_{jp}$  is the walking distance between destination  $j$  and parking facility  $p$ .  $\theta_c$  is the parking charge discount for commodity  $c$ .  $d_{cp}$  is the parking duration of commodity  $c$  at parking facility  $p$ .  $h_p$  is the hourly parking cost at parking facility  $p$ .

Lam et al. (2006) developed a parking choice model as a time-dependent network equilibrium model. The study revealed that travel demand, walking distance, parking capacity, and parking charge significantly affect the parking behavior. The model can explain temporal and spatial

interaction between parking congestion and road traffic. Joint choice of departure time and parking duration is formulated as multinomial logit model.

Comparing between survey-based choice models and network-based approach, we can see that network approach is more flexible solution to the problem that is investigated in this report.

#### **2.4 Network Design Problem**

Network design problems (NDPs) have been widely used to identify the best, among many network expansion policy alternatives, and are often modeled as BLPPs. Basically, formulation of an NDP as a BLPP consists of two levels: the upper-level problem that is relevant to managerial decision-makers and the lower-level problem that is described by the traffic assignment problem. In general, a bi-level programming problem (BLPP) is formulated as follows (Kolstad 1985):

$$\min_x F(x, y) \tag{2.20}$$

$$s.t. \quad G(x) \leq 0 \tag{2.21}$$

$$\min_y f(x, y) \tag{2.22}$$

$$s.t. \quad g(x, y) \leq 0 \tag{2.23}$$

Equation 2.20 and 2.21 are defined as upper level problem and Equation 2.22 and 2.23 are defined as lower level problem.

BLPPs have been used to solve many NDPs, including road pricing (Yang and Bell, 1997; Labbe`, Marcotte and Savard, 1998), link improvement (Abdulaal and Leblanc, 1979; Friesz et al., 1992; Davis, 1994), and traffic signal control problems (Marcotte, 1983; Fisk, 1984).

NDPs also have been applied to determine optimal decisions for parking facilities. Tam and Lam (2000) suggested a model to determine the maximum number of cars by zones considering network capacity and parking space. Garcia and Marin (2002) presented a model to determine optimal parking investment and pricing. Zhichun et al. (2007) studied the optimization problem to determine parking charging and supply.

#### **2.5 Stochastic Programming**

Stochastic programming is widely used as a modeling framework for optimization problems that deal with uncertainty parameters. The general goal of stochastic programming is to find the most

feasible alternative for the possible data instances through maximizing the expectation of decision functions. The classical two-stage stochastic linear programming was introduced by Dantzig (1955) and Beale (1955) as the following:

$$\min z = c^T x + E_\epsilon \left[ \min q(\omega)^T y(\omega) \right] \quad (2.24)$$

$$s.t. \quad Ax = b \quad (2.25)$$

$$T(\omega)x + Wy(\omega) = h(\omega) \quad (2.26)$$

$$x \geq 0, y(\omega) \geq 0 \quad (2.27)$$

where,  $\omega$  is a random event; each component of  $q(\omega)$ ,  $T(\omega)$ , and  $h(\omega)$  is a possible random variable; and  $x$  and  $y(\omega)$  are decision variables.

First, the first-stage decision  $x$  is determined without realizing random event  $\omega$  and second-stage data. After the random event is realized, the second-stage problem data,  $q(\omega)$ ,  $T(\omega)$ , and  $h(\omega)$ , become known. Then, the second-stage decision  $y(\omega)$  can be determined.

In stochastic programming, some variables are determined by decision-makers and some parameters are determined by chance. Stochastic programming can be subdivided into a simple recourse model and a full recourse model, depending on when the decision-maker makes decisions. While Equations 2.24 through 2.27 indicate a typical recourse model, if the second decision variable is disregarded, the stochastic programming problem becomes a simple recourse model.

Stochastic programming has been applied to many areas, including economy policy (Mulvey and Vladimirou 1991; Birge and Rosa 1995), power systems (Pereira and Pinto 1991; Takriti 1995), finance (Carino et al. 1994), and transportation (Frantzeskakis and Powell 1990; Powell 1990). The models in this report also considered uncertainties in parameters in the forms of stochastic programming problem.

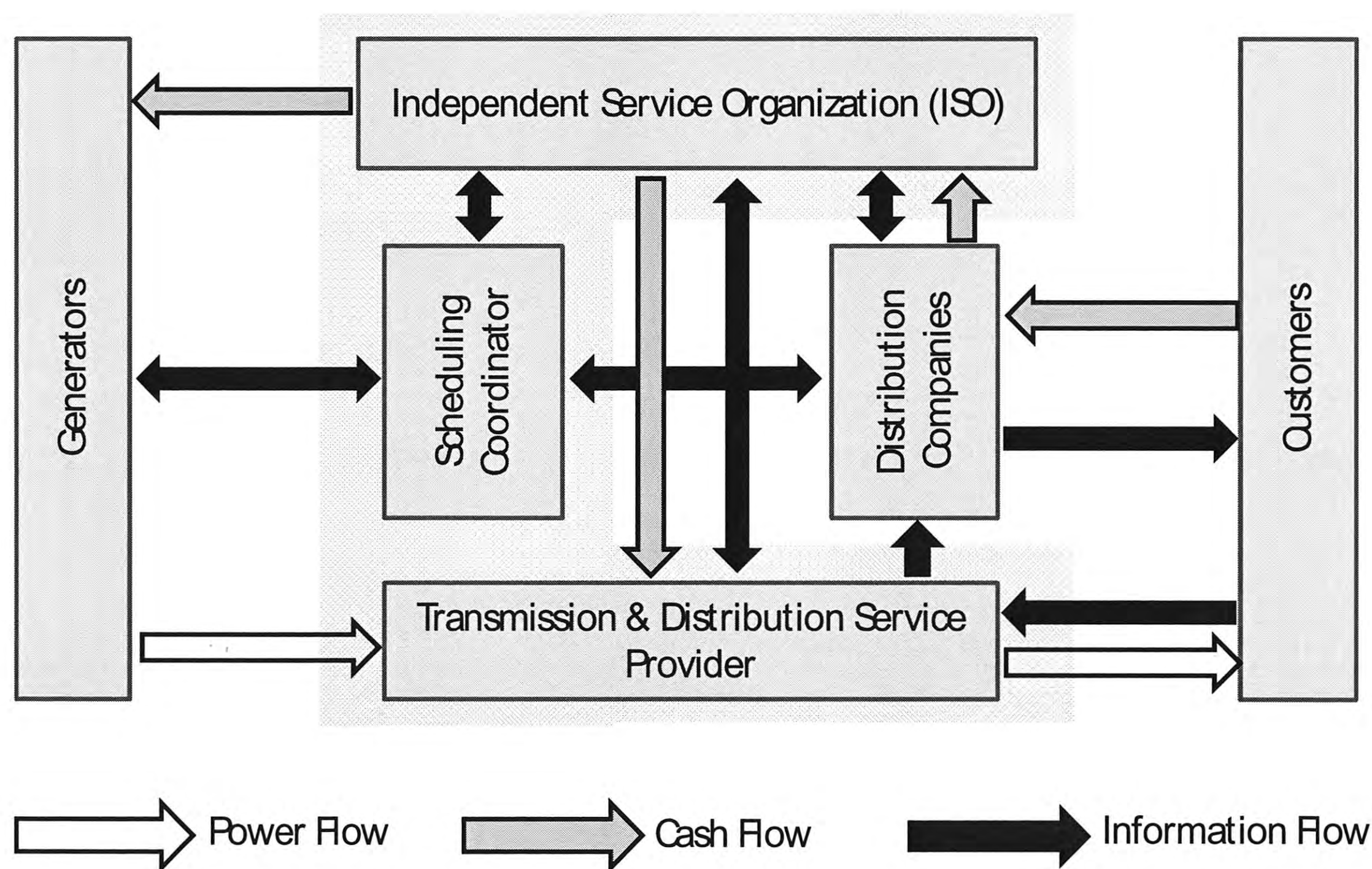
## **2.6 Electricity Power Market**

A number of studies have accounted for the potential impact of PEVs on power systems (Hadley and Tsvetkova 2008; Parks, Denholm, and Markel 2007; Denholm and Short 2006; Axsen and Kurani 2008). These studies show various impacts, such as load profile, cost of electricity, and generation from PEVs, depending on some plausible scenarios using assumed or surveyed

parameters. More specifically, previous studies have mostly focused on the impact of PEV penetration on macro-level power systems like the case in California, the Northeast, or nationally.

The power market could generally be divided into two markets—the zonal market of the macro level, and the nodal market of the micro level—in terms of the size of the control area. In the United States, the nodal power market has become the preferred market, beginning in 2000. The reported drawbacks of the zonal power market are the absence of effective competition and the increase in the power of the monopolist (Harvey and Hogan 2000). Presently, California, New England, ERCOT<sup>2</sup>, and PJM (including all or parts of 13 states and the District of Columbia) employ the nodal market.

Figure 2.1 shows a power market structure. Electric power propagates from generators to customers through a transmission and distribution (T&D) service provider. On the other hand, cash is channeled in the opposite direction, from customers to generators and T&D providers. Information, including power price and amount of power supply and demand, is exchanged among the entities. PEV infrastructure can be both generator and customer.



**Figure 2.1 Power Market Structure**

<sup>2</sup> Electric Reliability Council of Texas

## 2.7 Economic Dispatch and Locational Marginal Price

Electric power system is operated in economic and reliable condition. Except at peak demand, available generation capacity is generally more than the total load and less than transmission capacity. Therefore, there are various possible generation assignments to satisfy the total loads and losses in the transmission links. ISO manages the electric power system in order to keep the system in reliable status with minimized generation cost, which is referred as economic dispatch (ED). The classic economic dispatch is formulated as shown in Equation 2.28 through 2.30 (Saadat 2002). Equation 2.28 is the objective function which minimizes the sum of all generation costs. Equation 2.29 indicates the balance between active power generations and total load. Equation 2.30 is the range of power generation.

$$\min f = \sum_{i=1}^m C_i(P_{gi}) \quad (2.28)$$

$$s.t. \quad \sum_{i=1}^m P_{gi} = P_L \quad (2.29)$$

$$P_{gi\min} \leq P_{gi} \leq P_{gi\max} \quad i = 1, \dots, m \quad (2.30)$$

where,  $C_i(\cdot)$  is the cost function of generator.  $P_{gi}$  is the real power generation of the  $i$ th generator.  $P_{gi\min}$  and  $P_{gi\max}$  are real power limits of the  $i$ th generator.  $m$  is the number of generators.  $P_L$  is the fixed load demand.

Settlement price for ancillary service and transmission congestion cost are estimated in terms of locational marginal price (LMP) that is the cost of providing the next increment of demand at a specific node. Different LMPs between buses are generally caused by power system operating conditions, such as transmission system, generation, and load. Ott (2003) presented mathematical LMP formulations that are utilized in PJM market as shown in Equation 2.31 through 2.35. Comparing classic economic dispatch, the equations for LMP consider transmission system configurations which are expressed as a shift factor in equations. Shift factors are a measure of the change in power flow on the constraint's monitored elements for a unit change in megawatt injection at a bus and a corresponding unit change in megawatt withdrawal at the reference bus.

$$\min Z = \sum_{i=1}^m C_i(\Delta P_i) - \sum_{j=1}^n C_j(\Delta P_{Lj}) \quad (2.31)$$



$$s.t. \quad \sum_{i=1}^m \Delta P_i - \sum_{j=1}^n \Delta P_{Lj} = 0 \quad (2.32)$$

$$\Delta P_{i \min} \leq \Delta P_i \leq \Delta P_{i \max} \quad (2.33)$$

$$\Delta P_{Lj \min} \leq \Delta P_{Lj} \leq \Delta P_{Lj \max} \quad (2.34)$$

$$A_{ik} \Delta P_i + D_{jk} \Delta P_{Lj} \leq 0 \quad (2.35)$$

where,  $A_{ik}$  is the matrix of shift factors for generation bus on the binding transmission constraints  $k$ .  $D_{jk}$  is the matrix of shift factors for load bus on the binding transmission constraints  $k$ .

LMP at a particular location is the sum of the marginal price of generation at the reference bus and the marginal congestion price at the location associated with the various binding transmission constraints. Formulation for LMP is as follows:

$$LMP_i = \lambda - \sum A_{ik} \times SP_k \quad (2.36)$$

where,  $\lambda$  is marginal price of generation at the reference bus.  $SP_k$  is shadow price of constraint  $k$ .

PEV parking building where will have a role of ancillary service will use LMP as clearing price for trading an electric power.

## 2.8 Summary

The literature review provided fundamental equations that are necessary to develop new problems. This chapter also presented the necessary background for creating a new facility location problem that can explain the interactions between transportation and electric power systems and a new charging station installation problem that considers uncertainty in parameters. In the following chapters, the basic problems from the literature are reformulated and adjusted for developing the new models that can help PEV parking building developers and managers make optimal decisions.



### 3. PEV PARKING BUILDING DEVELOPMENT PROBLEM

Unlike conventional parking buildings, PEV parking buildings can provide charging services to users and contract with an independent system operator (ISO) to service the grid and make a profit. This chapter presents a mathematical model for finding the optimal location and operations plan for a new PEV parking building.

The revenue of PEV infrastructure project is closely related to the number of parked PEVs. The location of a PEV parking building and the amount of (dis)incentive (fee or rebate) are important factors when drivers decide where to park. Details of the problem description will be discussed in the first section of this chapter. In the second section, a mathematical model for a PEV parking building problem is formulated in the form of a BLPP. Then, in the third section, two numerical examples are presented.

#### 3.1 Problem Description

Commercial and public parking buildings in a central business district (CBD) provide thousands of parking spaces for commuters and visitors. However, none of these facilities are equipped with charging infrastructure for PEVs. In the future, PEV owners will consider parking their vehicles in buildings that can provide charging services for depleted vehicle batteries.

A PEV parking building represents an interface between a transportation network and an electric power system. Figure 3.1 shows a PEV parking building acting as the interface between the two networks: it provides charging services for PEV drivers, which is a G2V operation; as well as ancillary services for an electricity power network, which is a V2G operation. To facilitate these operations, a PEV parking building needs to communicate with an ISO to obtain prices and to identify the amount of available electricity to provide.

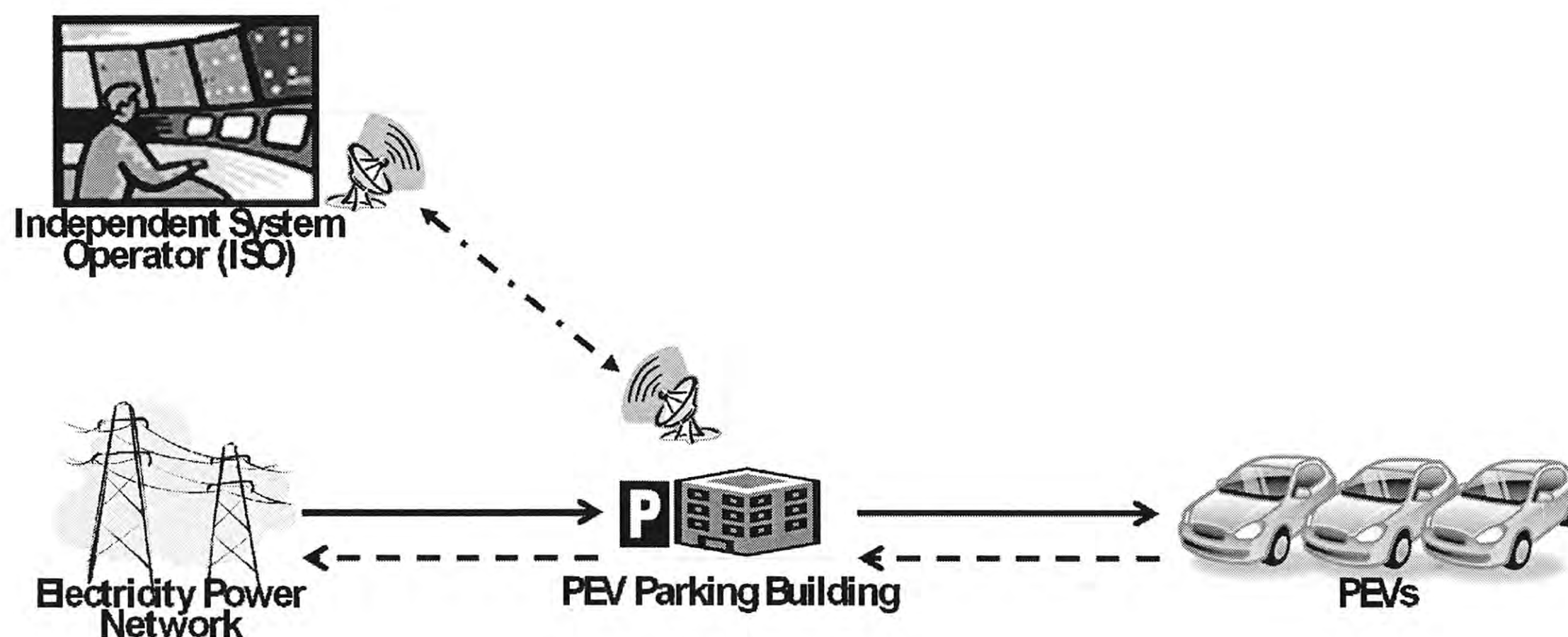
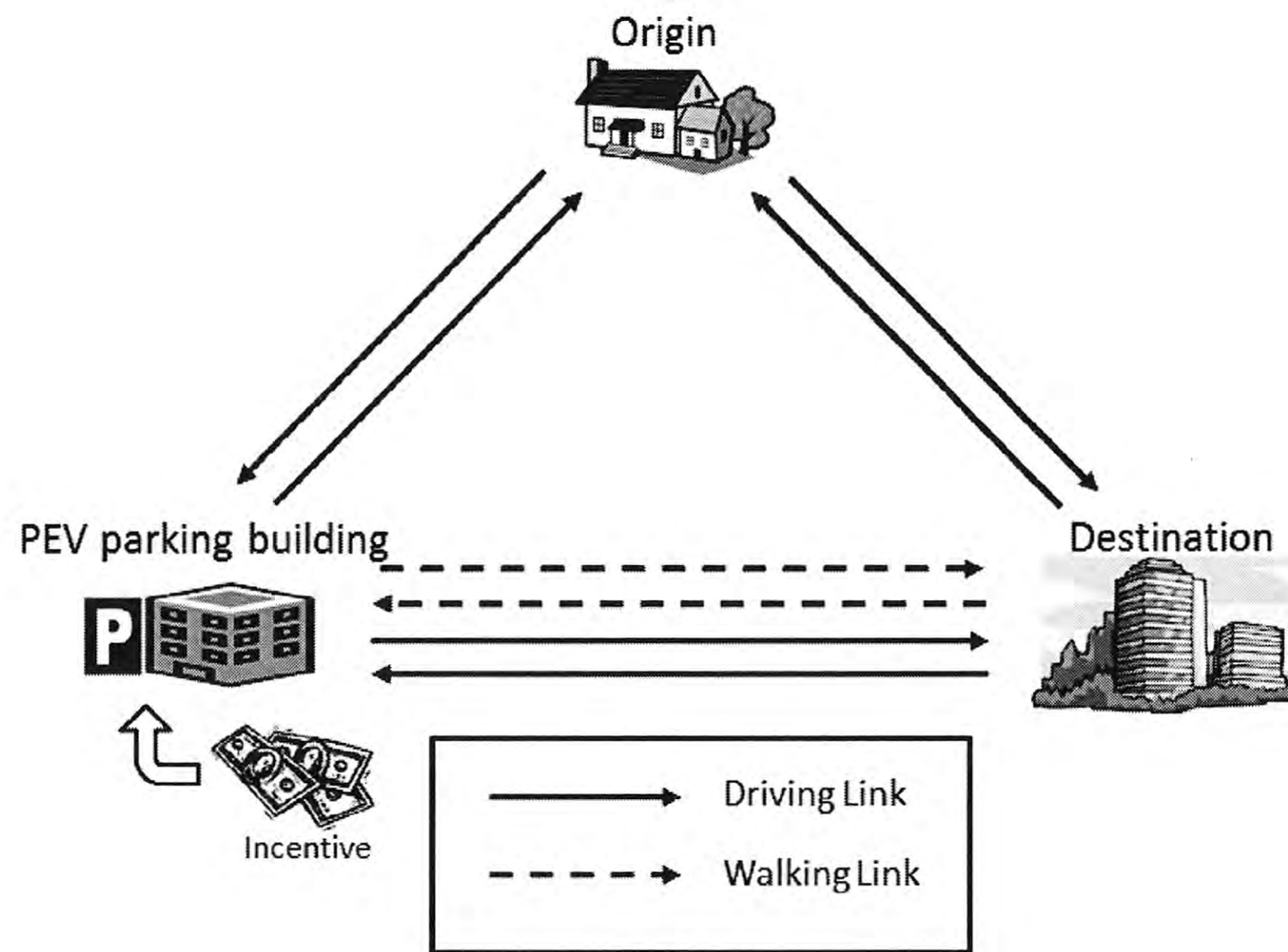


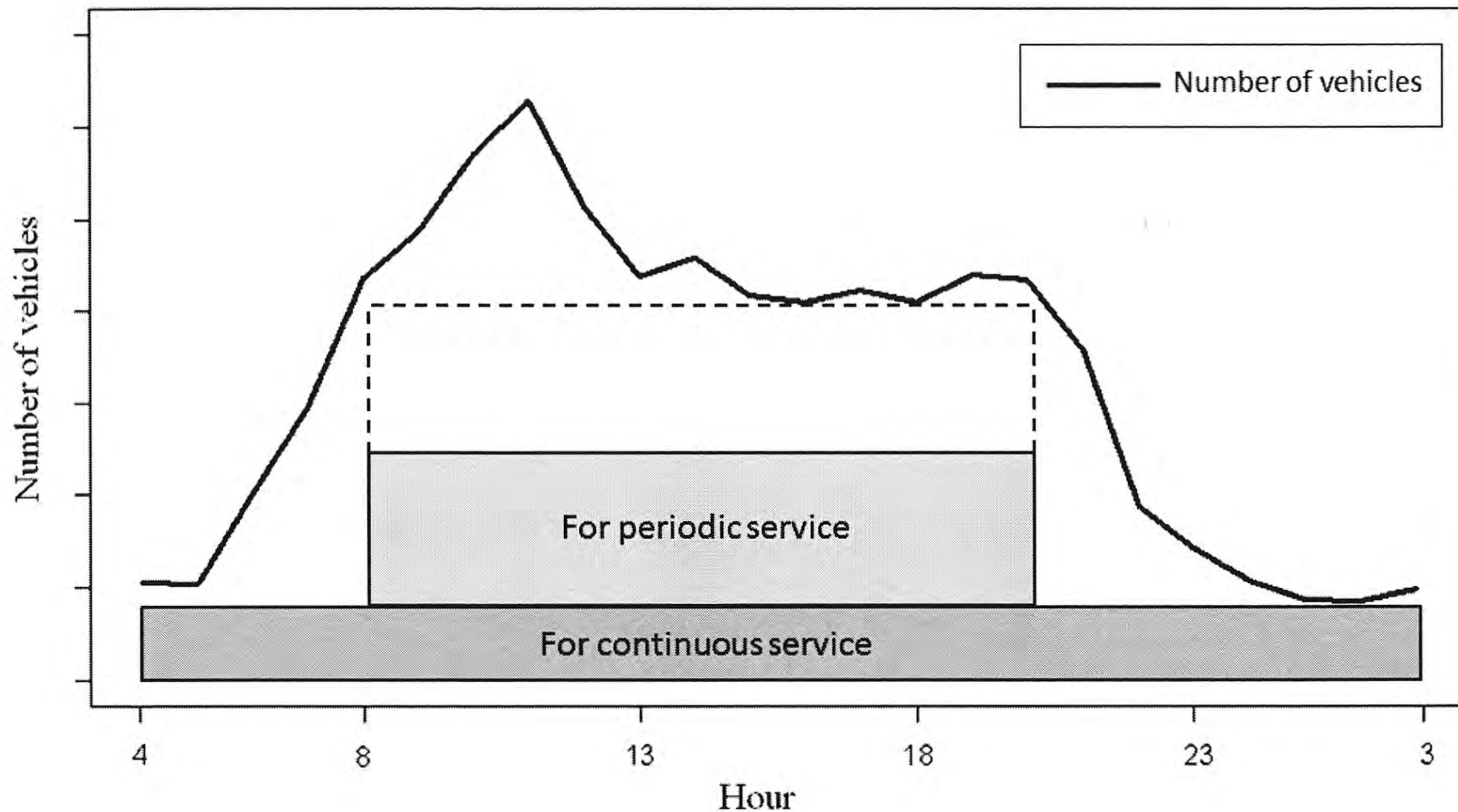
Figure 3.1 Roles of PEV Parking Building

Figure 3.2 shows a simple transportation network with a PEV parking building. When a new PEV parking building is constructed, PEV drivers have two options: proceed to the final destination directly, or park at the PEV parking building and walk to the destination. Drivers in transportation networks select a parking garage based on multiple factors. These include cost of parking, congestion on links, walking distance, and others. In this problem, the location of the PEV parking building and the fee structure are considered decision variables (i.e. under control of the parking garage developer).



**Figure 3.2 Simple Transportation Network with PEV Parking Building**

The electric power capacity of a PEV parking building is estimated based on the total number of parked PEV vehicles or in other words PEV parking demand. Generally, the PEV parking demand varies during the day. It is higher during business hours and lower during the night, similar to the demand for a conventional parking building, as shown in Figure 3.3. This poses a problem to the garage operator that wants to provide services to the grid using guaranteed generating capacity in patterns of parked vehicles. Due to this variance, electric power capacity is defined in two parts—for periodic service, and for continuous service—as shown in Figure 3.3. The available electric power during business hours can be used to procure peak demand service, while leveled constant capacity (0-24hr) can be used to provide regulation service in the V2G mode of operation.



**Figure 3.3 Example of Demand of PEV Parking Building for One Day**

To standardize the proposed problems, four key assumptions are considered:

- When choosing travel paths, users follow the user equilibrium principle (Wardrop 1952). Wardrop's first principle implies that drivers choose the routes that minimize the travel cost. The user equilibrium is obtained when no driver can find a lower transportation cost as a result of changing his or her route choice.
- The parking building users return from the destination to the origin directly. For simplicity, trip chaining is not considered.
- The time interval is defined as one hour and all trips occur within this time interval. Traffic flow from the origin to the destination and from the destination to the origin is generated every hour, and parking duration is defined in the unit of one hour.
- Penetration (or adoption) rate of PEVs is constant. Ratio of PEVs to all vehicles of traffic flow would be different every hour and on every link, but, for simplicity, the ratio is assumed as being constant.

### **3.2 The Model**

Consider a directed network  $G(N, A)$  of  $N$  nodes and  $A$  links, where set  $A$  consists of two subsets of links: driving (roadway) and walking (sidewalk) links,  $A_D$  and  $A_W$ , respectively. The network includes  $k$  origin-destination (O-D) pairs  $(r_i, s_i)$ ,  $r_i, s_i \in N$ ,  $i = 1, \dots, k$ , and  $\theta$  mode transfer nodes.

The PEV parking building problem in this study was formulated to determine the optimal location and (dis)incentive structure on a pre-specified link. The PEV parking building problem has two level problems. The notations of the PEV parking building problem are as follows:

#### Sets

- $A_D$  = the set of driving links in the O-D trip
- $A_W$  = the set of walking links in the O-D trip
- $J$  = the set of path of the ICEV
- $K$  = the set of path of the PEV
- $N$  = the set of nodes
- $W$  = the set of path of non-users of the PEV parking building
- $Y$  = the set of path of users of the PEV parking building

#### Parameters

- $c_a$  = the capacity of the driving link
- $c_b$  = the capacity of the walking link
- $E_{dis}$  = the total energy dispatched over the contract period
- $f$  = the parking fee at the conventional parking building
- $f'$  = the parking fee at the PEV parking building
- $I$  = the upper limit of incentive ( $i$ )
- $L$  = the upper limit of distance ( $l$ )
- $P$  = the power limited by a vehicle's stored energy
- $P_{cap}$  = the capacity price
- $P_{con}$  = the contracted capacity (MW)
- $R_{d-c}$  = the dispatch-to-contract ratio

- $s_a$  = the average speed of cars  
 $s_b$  = the average speed of pedestrians  
 $t_{con}$  = the duration of the contract  
 $U$  = the upper limit of parking hours ( $u$ )  
 $\hat{Z}_h$  = the forecast power price  
 $\gamma$  = the incentive parameter  
 $\delta_{a,j}^{rs}$  = the indicator variable—1 if link  $a$  is on path  $j$  of ICEV connecting O-D pair  $r-s$ , 0 otherwise  
 $\lambda$  = the power extraction ratio  
 $\tau$  = the ratio of PEVs to all vehicles

#### Variables

- $d_h(\cdot)$  = the PEV parking demand on time  $h$   
 $(f_j^{rs})_h$  = the flow on path  $j$  of ICEV connecting O-D pair  $r-s$  on time  $h$   
 $i$  = the incentive provided by the PEV parking building  
 $l$  = the distance between the PEV parking building and destination  
 $(q_j^{rs})_h$  = the trip rate of ICEV connecting O-D pair  $r-s$  on time  $h$   
 $r_{PF}(\cdot)$  = the revenue from the parking fee  
 $r_{PH}(\cdot)$  = the revenue from the peak hour service  
 $r_{RS}(\cdot)$  = the revenue from the regulation service  
 $r_{Total}(\cdot)$  = the total revenue

$t_a(\cdot)$  = the driving link cost function

$t_b(\cdot)$  = the walking link cost function

$(x_a)_h$  = the link flows on driving links at time  $h$

$(x_b)_h^u$  = the link flows on walking links at time  $h$  and with  $u$  parking hours

The PEV parking building problem is formulated as follows:

$$\max_{l,i} r_{Total}(l,i) = r_{PF}(l,i) + r_{RS}(l,i) + r_{PH}(l,i) \quad (3.1)$$

$$s.t. \quad 0 \leq l \leq L \quad (3.2)$$

$$0 \leq i \leq I \quad (3.3)$$

$$d_h(l,i) = \sum_{u=1}^N (x_b)_h^u + \sum_{u=2}^N (x_b)_{h-1}^u + \dots + \sum_{u=n}^N (x_b)_{h-(n-1)}^u \quad \forall b \in A_w \quad (3.4)$$

$$\min \sum_{A_D} \int_{\omega=0}^{\omega=x_a} (t_a(\omega, l, i))_h d\omega + \sum_{A_w} \int_{\omega=0}^{\omega=x_h} (t_b(\omega, l, i))_h d\omega \quad (3.5)$$

$$s.t. \quad \sum_j (f_j^{rs})_h = (q_j^{rs})_h \quad \forall r \in N, \forall s \in N \quad (3.6)$$

$$\sum_k (f_k^{rs})_h = (q_k^{rs})_h \quad \forall r \in N, \forall s \in N \quad (3.7)$$

$$\sum_w (f_w^{sr})_h = (q_w^{sr})_h \quad \forall r \in N, \forall s \in N \quad (3.8)$$

$$\sum_y (f_y^{sr})_h = (q_y^{sr})_h \quad \forall r \in N, \forall s \in N \quad (3.9)$$

$$(f_j^{rs})_h, (f_k^{rs})_h, (f_w^{sr})_h, (f_y^{sr})_h \geq 0 \quad \forall r \in N, \forall s \in N, \forall j \in J \quad (3.10)$$

$$\forall k \in K, \forall w \in W, \forall y \in Y$$



$$\begin{aligned}
(x_a)_h = & \sum_r \sum_s \sum_j (f_j^{rs})_h \delta_{a,j}^{rs} + \sum_r \sum_s \sum_k (f_k^{rs})_h \delta_{a,k}^{rs} \\
& + \sum_r \sum_s \sum_w (f_w^{sr})_h \delta_{a,w}^{sr} + \sum_r \sum_s \sum_y (f_y^{sr})_h \delta_{a,y}^{sr} \quad \forall a \in A \quad (3.11)
\end{aligned}$$

$$(x_b)_h = \sum_r \sum_s \sum_k (f_k^{rs})_h \delta_{b,k}^{rs} + \sum_r \sum_s \sum_y (f_y^{sr})_h \delta_{b,y}^{sr} \quad \forall b \in A_t \quad (3.12)$$

The upper-level objective function specified in Equation 3.1 consists of three revenue components: parking fee (disincentive), regulation service fee, and peak demand service fee. Equations 3.2 and 3.3 define the location and incentive decision space. Equation 3.4 defines the PEV parking demand based on the results from the user equilibrium problem. The lower-level problem is the user equilibrium problem with two user classes (PEV and ICEV), time-dependent trip rates, and walking link costs.

### 3.2.1 Lower-Level Problem

Construction of a PEV parking building changes the topology of a transportation network and drivers' behaviors. As it represents an additional node, the existing driving and walking link cost functions can be modified to account for changes in network topology and the link cost. The modified driving and walking link cost functions are discussed in the Modified Link Cost Functions section.

O-D trip rates and parking hours are considered deterministic. Destination-origin (D-O) trip rates are calculated from the result of the O-D assignment problem and assumed parking hours. There are two types of D-O trip rates: "proceed to origin directly" and "walk to the PEV parking building and drive to origin." Here, D-O trip rate of "proceed to origin directly" is derived from O-D trip rate of ICEV and PEV which do not park at PEV parking building, while D-O trip rate of "walk to the PEV parking building and drive to origin" is calculated from O-D trip rate of PEV which park at PEV parking building. The details for trip rates are discussed in the Trip Rates section.

#### 3.2.1.1 Modified Link Cost Functions

A Bureau of Public Roads (BPR 1964) function has been widely used by researchers and engineers to model travel time/cost on roadway links. A similar function was developed by Fox and Associates (1994) for modeling pedestrian travel on walking links. Free-flow driving and walking time is derived from the lengths of the driving and walking links ( $l_a$  and  $l_b$ ) and the

average speeds of vehicles and pedestrians ( $s_a$  and  $s_b$ ). Equations 3.13 and 3.14 present modified link cost functions, where the walking link cost function in Equation 3.14 includes the effect incentive ( $-\gamma \cdot i$ ) on the travel time.

$$t_a = \frac{l_a}{s_a} \left[ 1 + \alpha_a \left( \frac{x_a}{c_a} \right)^{\beta_a} \right] \quad a \in A_D \quad (3.13)$$

$$t_b = \frac{l_b}{s_b} + \alpha_b \left( \frac{x_b}{c_b} \right)^{\beta_b} - \gamma \cdot i \quad b \in A_W \quad (3.14)$$

where, the quantities  $\alpha$  and  $\beta$  are model parameters.

In Equation 3.14,  $\gamma$  represents a cost parameter that transfer walking time into cost function. For example, an incentive parameter  $\gamma$  of 20 means that people will price 20 minutes of walk as \$1. This incentive parameter affects by the walkability of the walking links. For example, people prefer to walk in urban area links, which means the incentive parameter  $\gamma$  increases with an increase in the quality of walking links. Several studies (Southworth 2005; Litman 2003; Hess et al. 1999) identified important attributes for the design of a pedestrian network, such as safety, quality of walking path, and connectivity of paths. Landis (2001) developed a mathematical model to measure pedestrian level of service (LOS) using statistical methods, while Hoogendoorn and Bovy (2004) developed a mathematical theory for pedestrian behavior in respect to walking cost and utility.

### 3.2.1.2 Trip Rates

This study considered bi-direction trips: O-D and D-O. The total O-D trip rates ( $q_{Total}^{rs}$ ) were divided into two categories: the trip rates of ICEVs ( $q_j$ ) and the trip rates of PEVs ( $q_k$ ) defined by the penetration rate of PEVs ( $\tau$ ). The trip rates were assumed to be generated in intervals of one hour and are defined as follows:

$$\left( q_{Total}^{rs} \right)_h = \left( q_j^{rs} \right)_h + \left( q_k^{rs} \right)_h = (1 - \tau) \left( q_{Total}^{rs} \right)_h + \tau \left( q_{Total}^{rs} \right)_h \quad (3.15)$$

$$\forall r \in N, \forall s \in N$$

While total O-D trip rates are divided by types of vehicles, the total D-O trip rates ( $q_{Total}^{rs}$ ) are divided by whether or not drivers use the PEV parking building. Hence, there are two D-O trip

rates: the rate for the vehicles that have not parked at the PEV parking building ( $q_w^{sr}$ ) and the rate for the vehicles that have ( $q_y^{sr}$ ). The D-O trip rates are defined as follows:

$$(q_{Total}^{sr})_h = (q_w^{sr})_h + (q_y^{sr})_h \quad \forall r \in N, \forall s \in N \quad (3.16)$$

The D-O trip rates are determined from the results of the previous O-D assignment problem. That is, drivers assigned to a PEV parking building in the previous O-D trips should walk back to the parking building in the D-O trip, and drivers assigned to a conventional parking garage in previous O-D trips should return to their origins directly in the D-O trip.

The link flows on  $A_w$  are composed of drivers who park for different parking hours, which is defined in Equation 3.17. The link flows  $(x_b)_h$  are part of  $(q_k^{rs})_h$  and are obtained from the assignment problem.

$$(x_b)_h = (x_b)_h^1 + (x_b)_h^2 + \dots + (x_b)_h^U \quad \forall b \in A_w \quad (3.17)$$

D-O trip rates,  $q_w^{sr}$  and  $q_y^{sr}$ , are calculated based on link flows  $(x_b)_h$ . Trip rate  $q_y^{sr}$  is derived from the pedestrian flows,  $x_b$ , of PEV drivers who parked their cars in the PEV parking building.

As discussed above,  $x_b$  could be divided into  $(x_b)^u$ 's, depending on parking hours,  $u$ . The parking hours,  $u$ , should be less than or equal to  $U$ . Drivers who have parked their vehicles for specific hours will leave the parking building after their stay at the destination node expires.

Therefore,  $(q_y^{sr})_{h+1}$  is defined as follows:

$$(q_y^{sr})_{h+1} = \sum_{u=1}^h (x_b)_{h+1-u}^u \quad \forall b \in A_w, \forall r \in N, \forall s \in N \quad (3.18)$$

Finally  $(q_w^{sr})_{h+1}$  is computed by subtracting  $(q_y^{sr})_{h+1}$  from D-O trip rates. It is defined as follows:

$$(q_w^{sr})_{h+1} = \sum_{u=1}^h \left[ (q_j^{rs})_{h+1-u}^u + (q_k^{rs})_{h+1-u}^u - (x_b)_{h+1-u}^u \right] \quad (3.19)$$

$$\forall b \in A_w, \forall r \in N, \forall s \in N$$

### 3.2.2 Upper-Level Problem

Kempton and Tomic (2005b) proposed a business model that can be applied to V2G technologies. The revenue from V2G technologies can be obtained from three types of services the garage provides to the grid: peak power, spinning reserve, and regulation. Much like in Kempton and Tomic's (2005b) model, the manager of a PEV parking building has an option to partially discharge the stored power from parked PEV batteries during parking hours. The total amount of available power is dependent on the number of parked PEVs, or, in other words, on the PEV parking demand ( $d_h$ ).

As previously mentioned, this study considered an upper-level objective based on three revenue components: the parking fee, the regulation service, and the peak hour service. The incentive that the PEV parking building could provide to the users can be considered as a cost, or a negative value of the parking fee. Hence, in an upper-level objective, there is a tradeoff between the parking fee and the cost of attracting more PEVs to park and get the value from ancillary service fees. When a PEV parking building is constructed at location  $l$  and provides incentive  $i$  to users, the revenue model from the parking fee is defined as follows:

$$r_{PF}(l, i) = \sum_{h=1}^{24} (d_h(l, i) \cdot f') \quad (3.20)$$

where,  $f'$  is the parking fee at a PEV parking building and is the difference between the parking fee at a conventional parking building ( $f$ ) and the incentive provided by a PEV parking building ( $i$ ).

In addition to the revenue from parking fees, the garage operator receives revenue from V2G operations. Utilizing the PEV in the PEV parking building, the operator contracts with an aggregator (or independent system operator) to provide power regulation storage and peak hour services.

The regulation service—one of the key ancillary services—corrects unintended fluctuations of power generation in order to meet a load demand. If a load demand exceeds power generation, PEVs discharge power from the battery, and if power generation meets a load demand, when battery capacity is abundant, PEVs charge power from the power grid. The PEV parking building can provide regulation service for 24 hours at the level of  $d^*(l, i)$ , as shown in Figure 3.3.

Kempton and Tomic (2005b) suggested a revenue model for regulation service as follows:

$$r_{RS}(l, i) = \sum_{h=1}^{24} d^*(l, i) \cdot (p_{cap} \cdot P + P \cdot R_{d-c} \cdot \hat{Z}_h) \quad (3.21)$$

where,  $P$  is the power limited by the vehicle's stored energy,  $d^*(l, i)$  is the minimum amount of vehicles for 24 hours,  $\hat{Z}_h$  is the forecast power price,  $p_{cap}$  is the capacity price, and  $R_{d-c}$  is the dispatch-to-contract ratio, as defined below:

$$R_{d-c} = \frac{E_{dis}}{P_{con} t_{con}} \quad (3.22)$$

where,  $E_{dis}$  is the total energy dispatched over the contract period,  $P_{con}$  is the contracted capacity (MW), and  $t_{con}$  is the duration of the contract.

The peak hour demand market is another source of revenue for the operator of a PEV parking building. The extracted power from the PEVs parked during the day can provide electric power, with the PEVs basically functioning as a distributed generator. The manager of the PEV parking building can contract with the ISO to sell power for a specific period. In this study, the specific period was defined as 8:00 a.m. to 8:00 p.m., when demand for the PEV parking building is high. The PEV parking building can extract power up to  $d^{***}$ , which would be the point that the battery in a PEV is drained. Therefore, defining a proper power extraction ratio ( $\lambda$ ) is essential. The revenue model for the peak hour services is defined as follows:

$$r_{PH}(l,i) = \sum_{h=8}^{20} (P \cdot d^{**}(l,i) \cdot \hat{Z}_h) \quad (3.23)$$

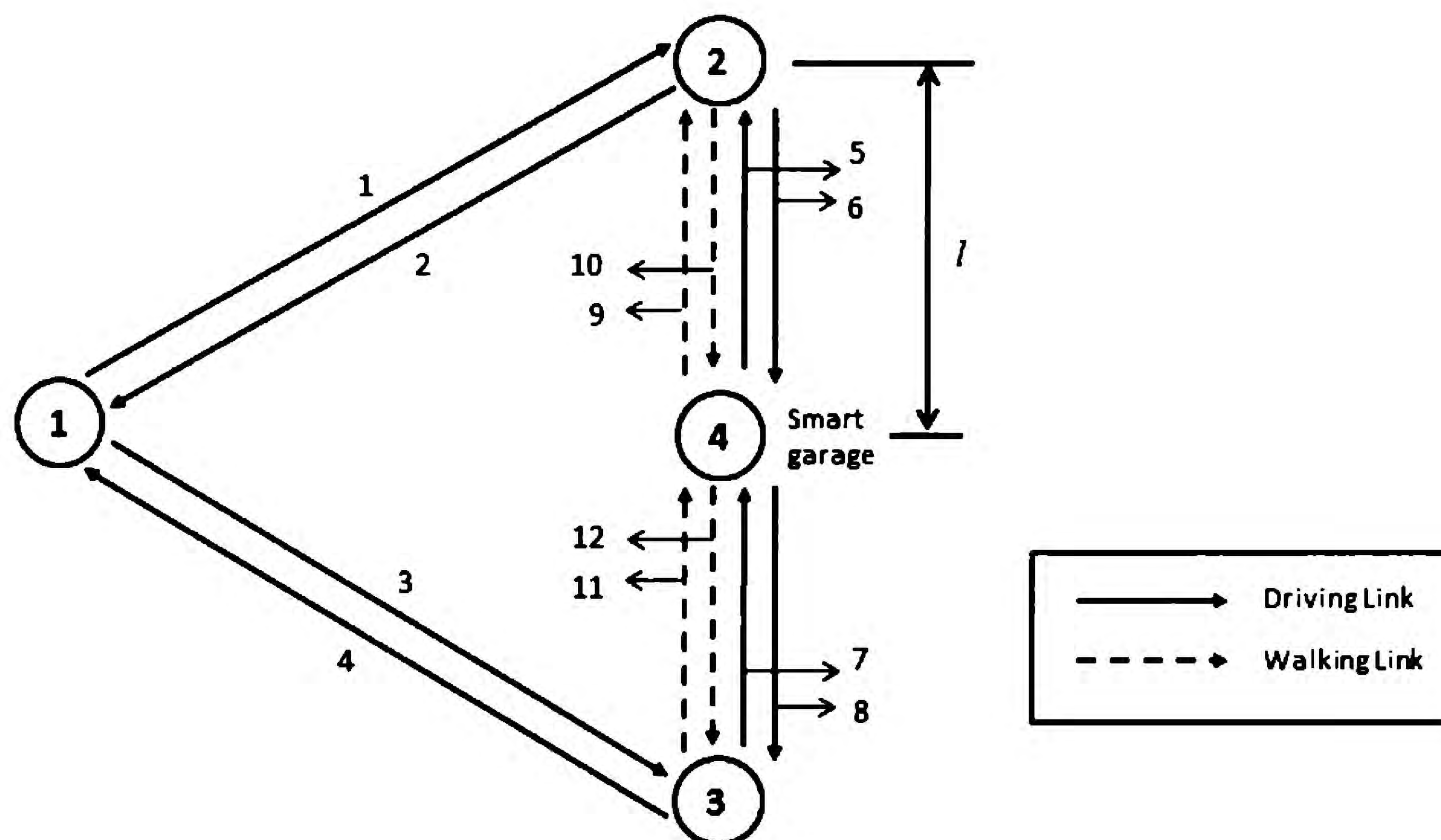
where,  $d^{**}(l,i) = \lambda(d^{***}(l,i) - d^*(l,i))$  and  $d^{***}(l,i)$  is the maximum amount of vehicles between 8:00 a.m. and 8:00 p.m.

### 3.3 Computational Study

Numerical examples to illustrate the application of the developed bilevel PEV parking building problem are presented next. In the first section, a simple network structure is considered to investigate system behavior when the effects can be isolated. In the next section, a large network is considered to capture realistic situations.

#### 3.3.1 Simple Network

A small example network shown in Figure 3.4 consists of four nodes and 12 links. It is assumed that node 2 and node 3 have a conventional parking garage and a PEV parking building is constructed at distance  $l$  from node 2. The links are divided into two types: driving links and walking links.



**Figure 3.4 Simple Network**

The driving links and walking links each have a link cost function, i.e. Equations 3.13 and 3.14. Lengths and capacities for each link are given in Table 3.1. Pedestrian trips are generally considered less than 1.6 km (Matley et al. 2000), but can extend to 3.0 km in a central business district (Ker and Ginn 2003). Based on the pedestrian trips in a central business district, the distance between nodes 2 and 3 is defined as 3.0 km.

**Table 3.1 Link Data for Example Network**

Link	Length $l$ (km)	Capacity $c$ (veh/h)	Link	Length $l$ (km)	Capacity $c$ (veh/h)
1	16	600	7	$3-l^*$	300
2	16	600	8	$3-l^*$	300
3	15	600	9	$l^*$	Inf.
4	15	600	10	$l^*$	Inf.
5	$l^*$	300	11	$3-l^*$	Inf.
6	$l^*$	300	12	$3-l^*$	Inf.

Parameters assumed in the computational study are described below.

For modeled link cost functions, the average speeds of vehicles and pedestrians ( $s_a$  and  $s_b$ ) are assumed to be 0.632 km/min and 0.1167 km/min, respectively (Pisarski 2006). Parameters  $\alpha_a$

and  $\beta_a$  in the cost function of the driving link are assumed as 0.15 and 4, respectively (LeBlanc 1975).

The sidewalk capacity in the cost function of walking links can be measured in a real network but, for simplicity, is assumed to be infinity. The incentive parameter ( $\gamma$ ) is assumed as 40, while the parking fee at a conventional parking garage at nodes 2 and 3 ( $f$ ) is assumed as \$1/hr.

The example network has two O-D pairs and four O-D and D-O trip rates, depending on the type of vehicles or whether or not they are parked in the PEV parking building, or not. As previously discussed, D-O trip rates are derived from the O-D trip rates and drivers' parking duration.

Further, the trip rates on each O-D pair ( $q_{Total}^{rs}$ )<sub>h</sub> are assumed to be deterministic.

Even though the ratio of PEVs to all vehicles of traffic flow would be different every hour, on every link, and on each origin-destination pair, for simplicity, the ratio is assumed as being constant in this example. The ratio of PEVs to all vehicles ( $\tau$ ) is assumed as 25% (Sort and Denholm 2006). With trip rates and the penetration ratio of PEVs, the ICEV and PEV flows are calculated. Finally, the forecasted power prices ( $\hat{Z}_h$ ) are summarized in Table 3.2.

**Table 3.2 Forecasts of Power Price Used for Numerical Example**

Hour	Power Price (\$/MW-h)	Hour	Power Price (\$/MW-h)	Hour	Power Price (\$/MW-h)
4	14.74	12	23.72	20	25.50
5	15.08	13	23.80	21	23.65
6	17.70	14	23.49	22	23.06
7	23.81	15	22.74	23	20.51
8	25.12	16	22.50	24	17.51
9	24.90	17	22.51	1	15.51
10	24.07	18	25.50	2	15.51
11	24.00	19	26.50	3	15.51

Depending on the facility location,  $l$ , and the incentive level,  $i$ , the link flows will vary. In the upper-level problem objective function (e.g., revenue), based on Kempton and Tomic's study (2005b), values for parameters are assumed as follows: the power limited by a vehicle's stored energy ( $P$ ) is assumed as 20 kWh, and the capacity price<sup>3</sup> ( $p_{cap}$ ) is assumed to be 30 \$/MW-h. The dispatch-to-contract ratio<sup>4</sup> ( $R_{d-c}$ ) is assumed as 0.1, and the power extraction ratio ( $\lambda$ ) is assumed as 0.5.

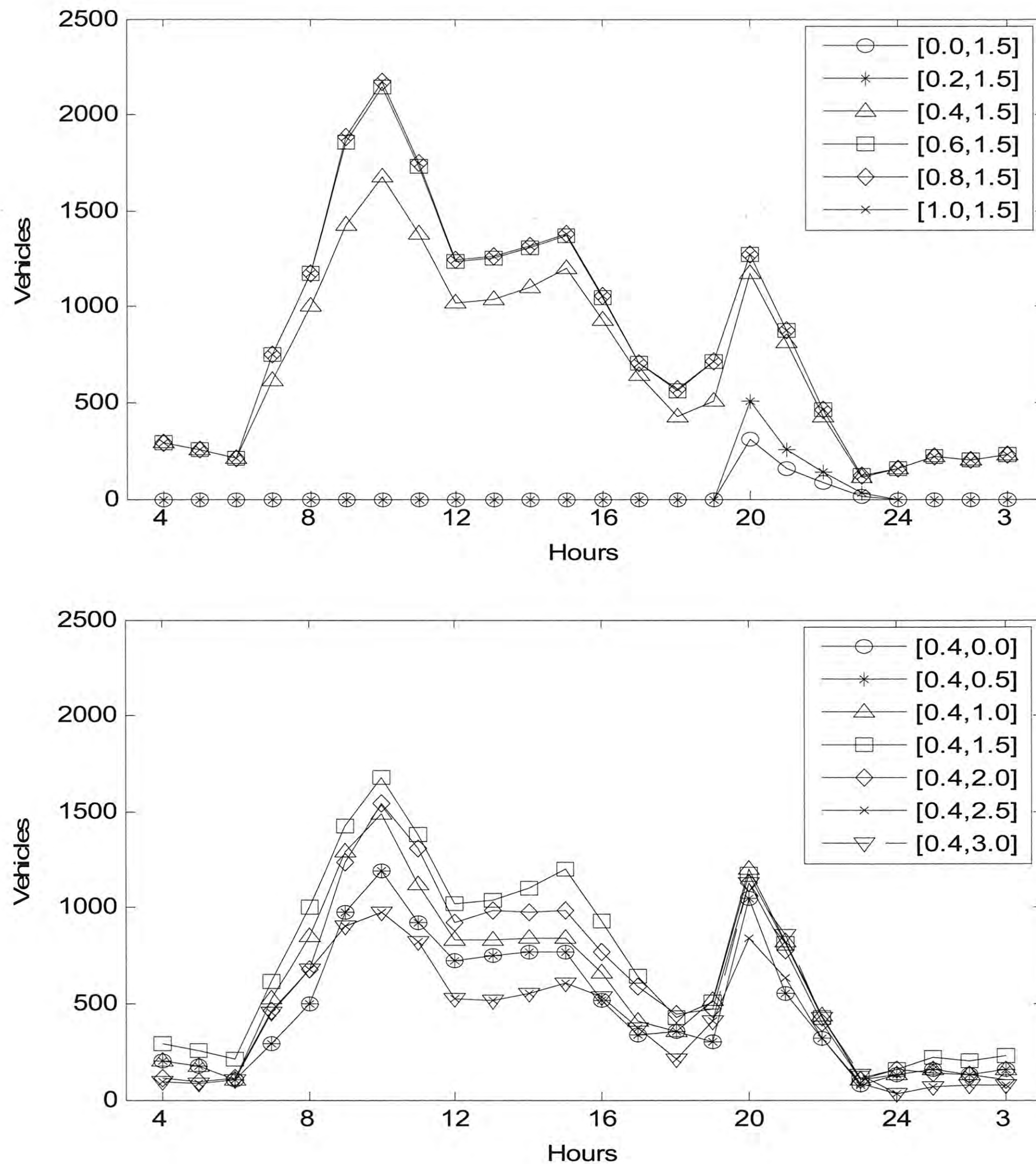
<sup>3</sup> This term is defined as the price paid to have a unit available for a specified service.

<sup>4</sup> This term is defined for that actual energy dispatched for regulation is some fraction of the total power available and contracted for.

### 3.3.1.1 Results

Figure 3.5 shows the demand patterns for the PEV parking building ( $d_h$ ) depending on  $l$  and  $i$ . In the legend, the first value in the parentheses indicates the amount of incentive in '\$' and the second value indicates the location of the PEV parking building in 'km'. The various garage demand scenarios were calculated by using combinations of the location and the incentive. It can be observed from the figure that as the incentive increases and the optimal location is centered between the two nodes, the PEV parking demand increases as well. This result shows that PEV parking demand will be the greatest, when PEV parking building is constructed where PEV drivers can move with minimizing their travel costs.





**Figure 3.5 Demands of PEV Parking Building Depending on Location and Incentive**

To find optimal solution, PEV parking development model in the forms of bilevel problem will have to be solved. As a bilevel nonlinear programming problem is an NP-hard problem (Hansen et al. 1992), a genetic algorithm (GA) was utilized. A genetic algorithm is a method of searching the fitness landscape for a highly fit (i.e. optimal) solution. This algorithm is inspired by evolutionary biology, as the population (solution) is increasingly better adapted, much like in the evolutionary process (Mitchell 1998). The simple form of a genetic algorithm typically consists of three types of operators, including selection, cross-over, and mutation. For the numerical example, basic GA operators are defined in Table 3.3.

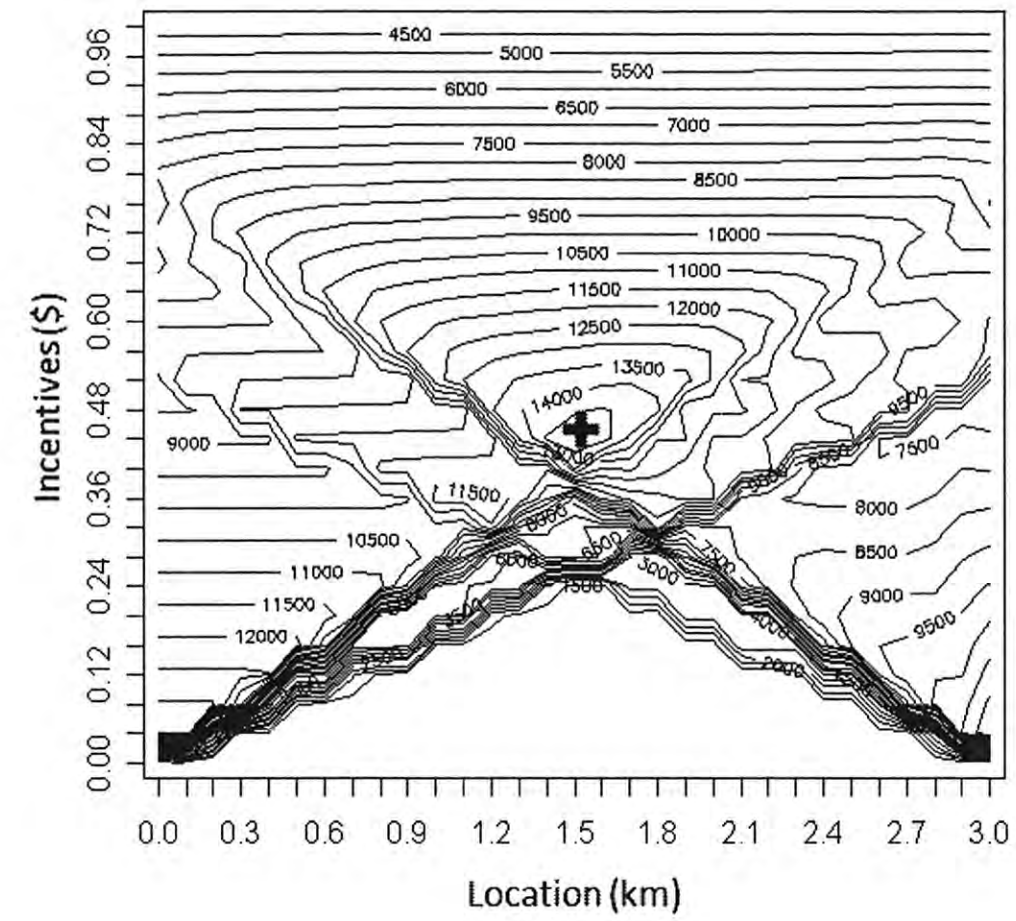
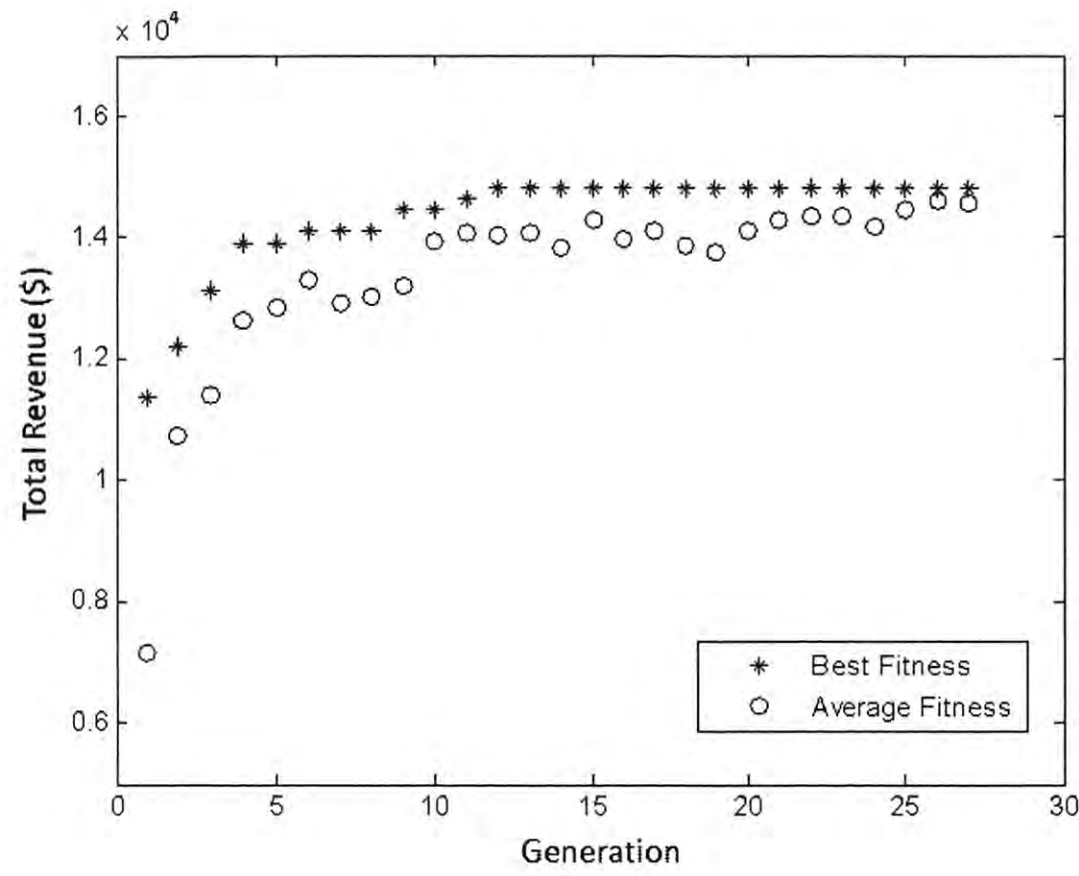
**Table 3.3 Methods and Parameters of GA Operators**

Operator	Method	Parameter
Selection	Binary Tournament Selection	1. Population size: 10 2. Elites: 2
Cross-Over	Simulated Binary Cross-Over	1. Rate of cross-over: 0.8 2. Distribution index ( $\eta$ ): 2
Mutation	Gaussian Mutation	1. Rate of mutation: 0.8 2. Standard deviation: <ul style="list-style-type: none"><li>• 0.05 (for incentive)</li><li>• 0.15 (for location)</li></ul>

The GA process is terminated by a defined stopping criterion. In this study, the stopping criterion was evoked if the successive best solutions no longer produced higher fitness (more than \$1) during 10 generations.

Graph (a) in Figure 3.6 shows the best fitness and average fitness for all generations. At the initial generation, GA explored decision space to find fitness values. Then, at the end of generation, GA found the best fitness value, which was around \$14,000. The maximized total revenue was obtained at \$14,817, and the optimal incentive and location were approximately \$0.44/hr and 1.53 km from node 2, respectively.

Graph (b) in Figure 3.6 presents a contour graph of the objective function (i.e. total revenue), which was calculated from 801 combinations using the enumeration method. The optimal point (“+” mark in the figure) was obtained from the GA operation. Graph (b) shows that, as incentive increases, location becomes a less important factor. In fact, drivers are incentivized to park in the PEV parking building and walk to their final destination. There is an optimal level of incentive at the point where the marginal increase in electric power generating potential (e.g., PEV parking demand) is equal to the marginal opportunity cost of charging for parking. For example, if developer provides more incentive, PEV parking demand will be increased, but total revenue could be decreased due to excessive incentive. Therefore, finding optimal incentive is very important to maximize a profit.

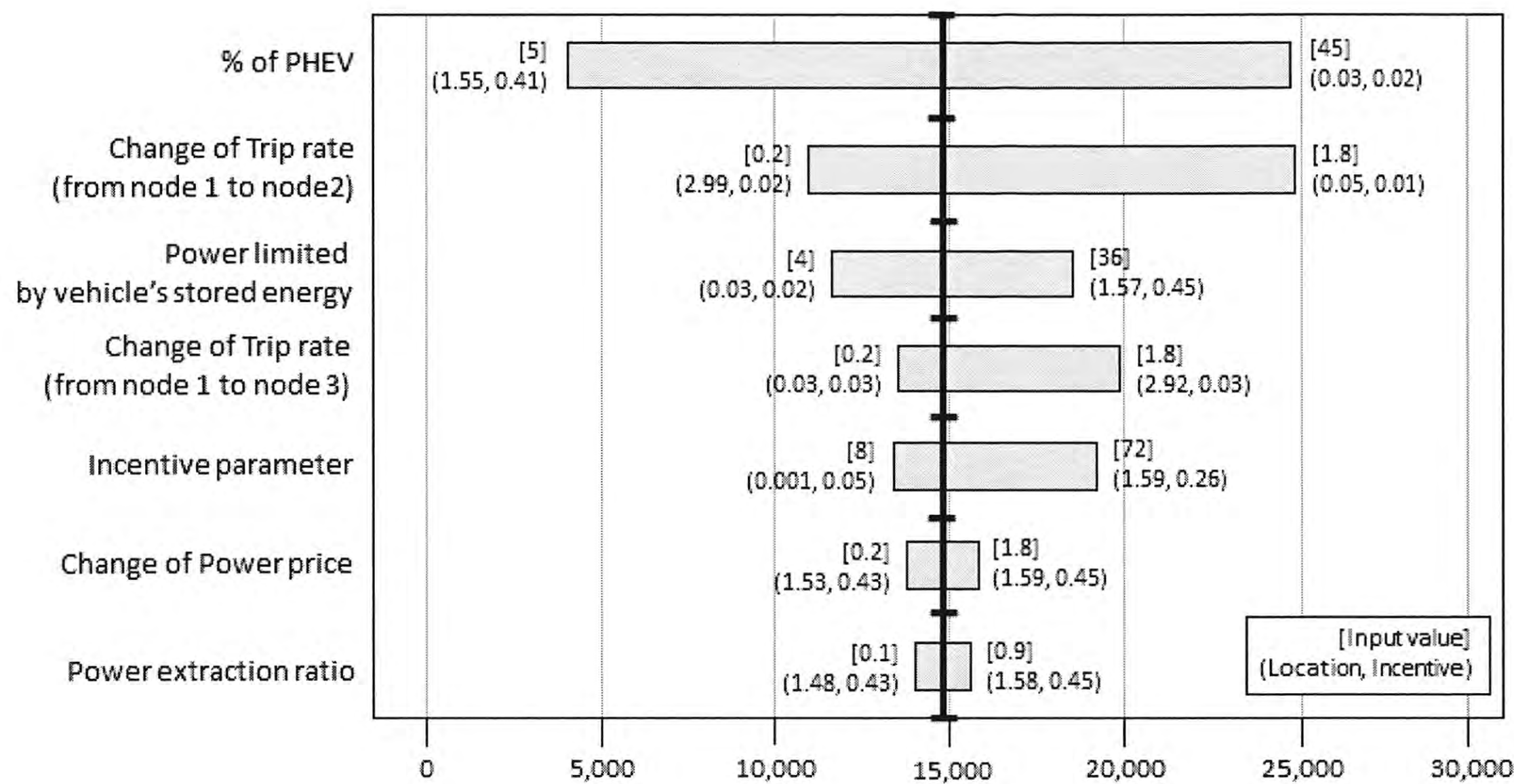


(a) (b)  
**Figure 3.6 Fitness and Contour Graph for Total Revenue**

### 3.3.1.2 Sensitivity Analysis

The suggested model is based on a number of empirical variables and parameters, including the battery limitation (i.e., power limited by the vehicle’s stored energy), ratio of extraction, and trip rates. As the value of these parameters is largely uncertain, a sensitivity analysis was conducted to understand the extent of their marginal influences.

Figure 3.7 shows the results of the sensitivity analysis. The penetration rate of a PEV ( $\tau$ ) and the power limited by the vehicle’s stored energy ( $P$ ) have the most significant effect on the total revenue when contrasted with the other parameters. The total revenue is sensitive to changes of trip rate from node 1 to node 2 much more than the changes of trip rate from node 1 to node 3. The difference of sensitivity comes from the volume of trip rate.



**Figure 3.7 Results of Sensitivity Analysis**

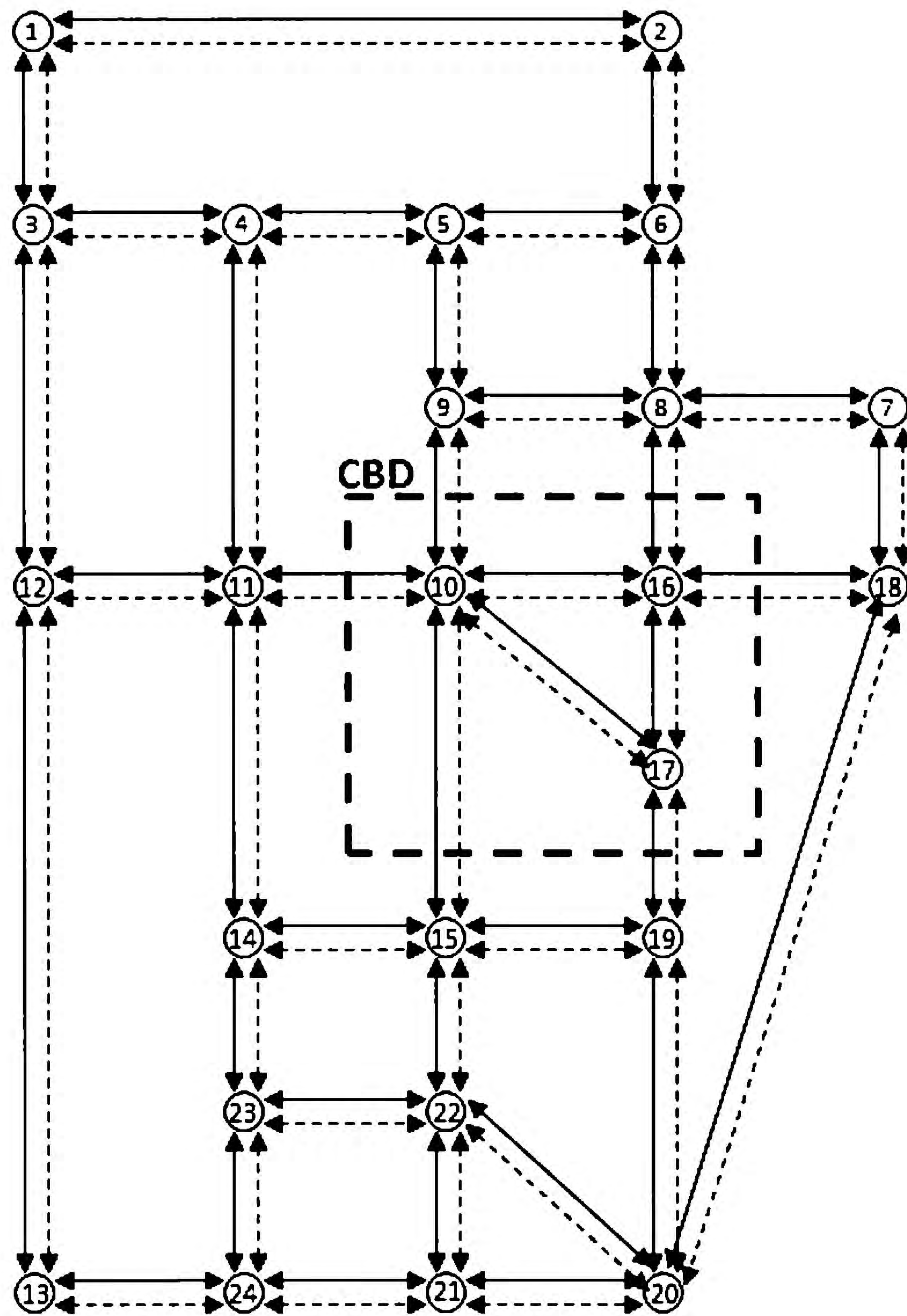
The sensitivity analysis also showed that the change of trip rate and incentive parameter could affect the optimal location and incentive. The optimal location is located close to the node where a greater trip rate is allocated, and the optimal incentive decreases as the location of the PEV parking building moves closer to the node with the conventional parking garage. Similar to the sensitivity analysis for the total revenue, the trip rate with the higher traffic flow has more influence on the total revenue.

The results of the sensitivity analysis indicate important implications for PEV parking building management. First, in the planning stage, the developer of the PEV parking building should consider long-term changes in future traffic flow and locate a PEV parking building closer to the node with the highest destination trip rate. Second, to attract more parking users, the operator needs to consider the walkability of walking links. For example, even if the manager of the PEV parking building provides much incentive, pedestrians do not want to walk through a dangerous area with poor walkability. Third, the operator of the PEV parking building can control the demand of the PEV parking building by manipulating the incentive structure (parking fee). For instance, when there is an excessive demand for a PEV parking building, the operator can readjust the incentive and reduce the demand of the PEV parking building, or vice versa. In other words, the operator should decrease the cost of parking fee to the level when total marginal benefits from V2G operations equal to the opportunity cost from parking service.

### 3.3.2 Large Network

PEV parking building model is applied next to larger and more realistic network, Sioux Falls network in Figure 3.8. The network consists of 24 nodes, 38 driving bi-directional links and 38

walking bi-directional links. Trip rates between nodes and parameters for link cost function are given in APPENDIX B and APPENDIX C, respectively. The network, trip rates, and parameters are referred from LeBlanc's work (1975). The values of other parameters, including average speed of vehicles and pedestrians, parking fee in conventional parking building, and electric power prices, are assumed equal to the case on the simple network used in the previous section.



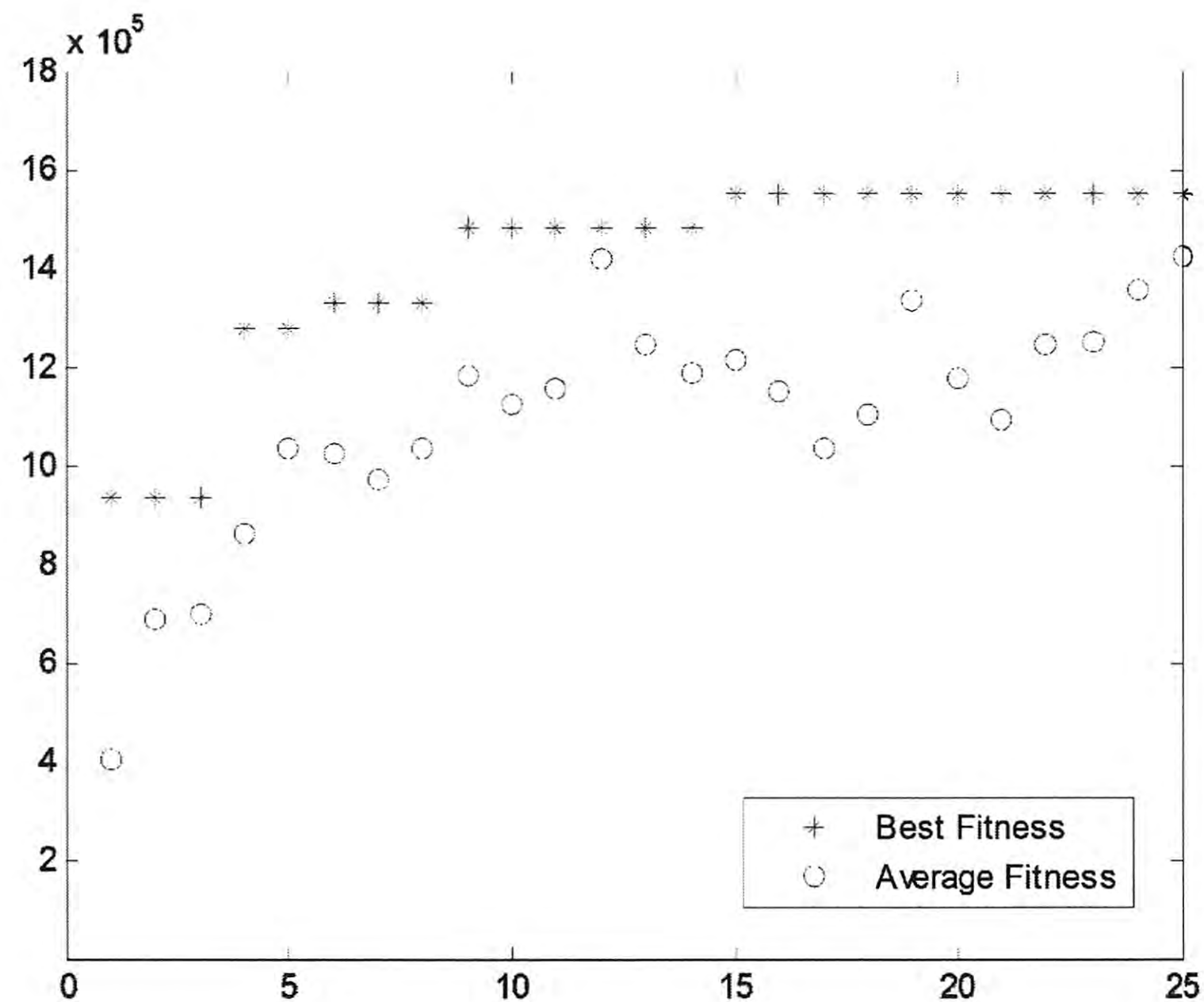
**Figure 3.8 Sioux Falls Network**

New PEV parking building will be constructed on the link in CBD. In other words, feasible spaces for the garage are between node 10, 16, and 17.

### 3.3.2.1 Results

Like in a simple network, the genetic algorithm approach is utilized to find optimal solution. The GA operators and methods are the same as in the simple network (see Table 3.3), but some parameters are defined differently; distribution index ( $\eta$ ) is defined as 1.5, and rate of mutation is defined as 0.2. Standard deviation for optimal location is defined as ‘ $0.05 \times \text{length of the link}$ ’, while standard deviation for incentive is defined as ‘ $0.05 \times 1$ ’.

Figure 3.9 shows the best fitness and average fitness for all generations. GA found the best fitness value, which was around \$1,550,000. The maximized total revenue was obtained at \$1,547,700. The optimal incentive was approximately \$0.24/hr, and optimal location of PEV parking building was 0.045 km from node 10 on the link between node 10 and node 16.



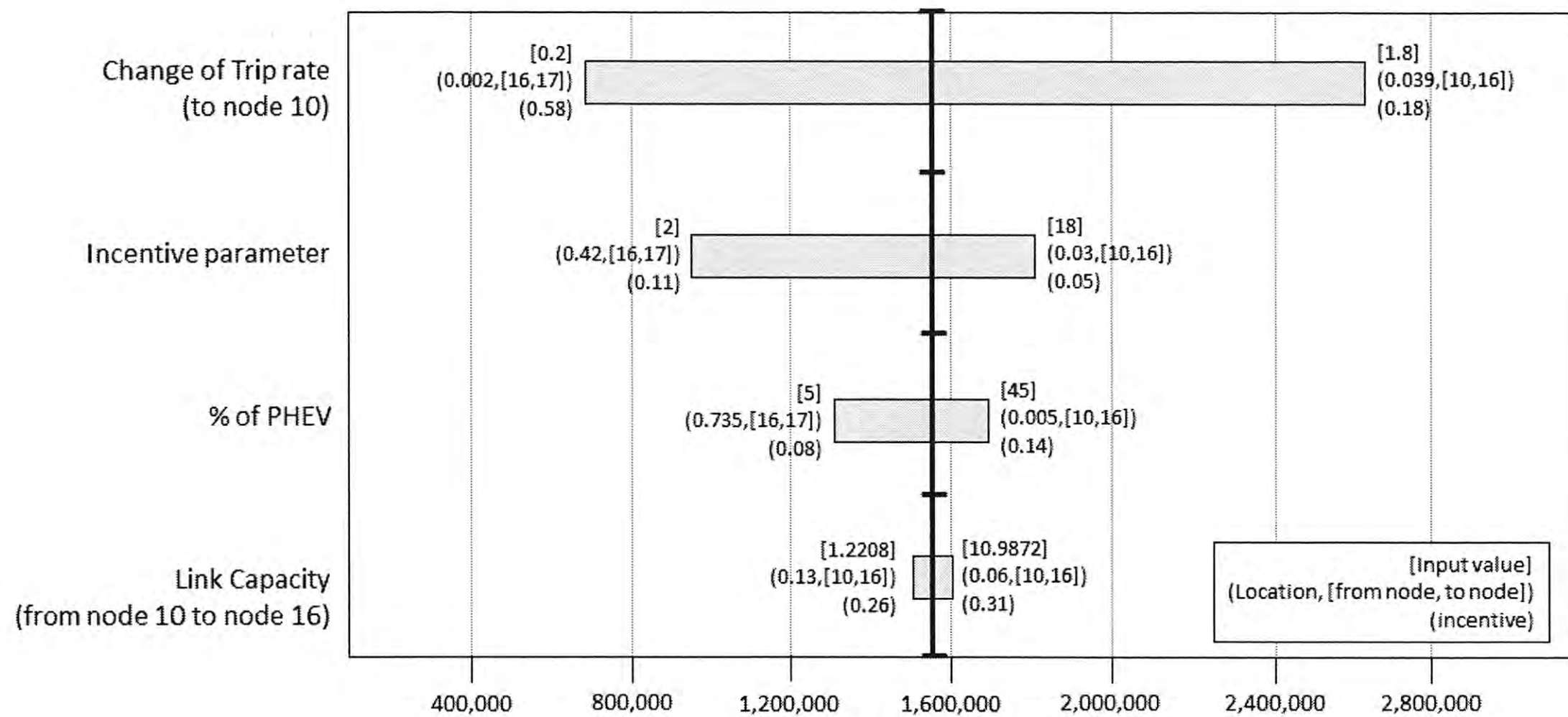
**Figure 3.9 Fitness Graph for Total Revenue**

The result confirms that optimal location is close to the node where the greatest trip rate is located. Among three nodes in CBD, node 10 has the higher trip rate and node 16 has the second most trip rate. The optimal location of PEV parking building is not only on the link between node 10 and node 16, but also closer to node 10.

### 3.3.2.2 Sensitivity Analysis

Figure 3.10 shows the results of the sensitivity analysis for large network. The result shows that the change of trip rate has the most significant effect on the total revenue when contrasted with

the other parameters. Unlike penetration rate of a PEV in the sensitivity analysis of simple network, the penetration rate of a PEV in the sensitivity analysis of large network is much less sensitive, which indicates penetration rate has more influence on small network or with less trip rate. The link capacities have the least effect on the total revenue.



**Figure 3.10 Result of Sensitivity Analysis**

When trip rate to node 10 is reduced to the ratio of 0.2, the total revenue decreases and the optimal location changes from the link between node 10 and node 16 to the link between node 16 and node 17. As trip rate to node 10 decreases, the optimal location of PEV parking building moves away from node 10. This change of the optimal location is also observed with changes in other factors, such as incentive parameter and penetration rate of PEV. As incentive parameter and penetration rate are reduced, the optimal location of PEV parking building is on the link between node 16 and node 17, not on the link between node 10 and node 16.

Sensitivity analysis of the large network provides similar implications for PEV parking building management. In a planning stage of PEV parking building project, the developer should carefully consider future change of trip rate. The trip rate shows significant influence on the total revenue and the location of PEV parking building. Also, developer needs to consider walkability of walking links, which is related to incentive parameter. Better walkability will bring more profit for developers.

### 3.4 Summary

This chapter presented a strategic model that can be used to determine the optimal location for a PEV parking building and the optimal incentive, or parking fee structure. Such a parking facility for PEVs represents an interface between a transportation network and an electric power system. Hence, traffic flows and power prices need to be considered simultaneously. In this study, a traffic assignment problem was used to determine transportation network flow with multi-class

users, time-dependent trip rates, and walking link costs. The results of the model show that demand for a PEV parking building is highly sensitive to selected location and incentive structure. Finally, the model was formulated as a bilevel problem with an upper objective composed from three revenue components: the parking fee, the peak hour service, and the regulation service.

Some fundamental insights into how the results in this study can be applied on real networks are provided. First, the maximum trip rate has a significant effect on the optimal location and incentive of a PEV parking building. Second, the walkability of walking links is an important factor in determining the optimal location and incentive and is related to the study of incentives. Sensitivity analysis shows that PEV parking demand is highly influenced by poor walkability, or lower incentive parameters.



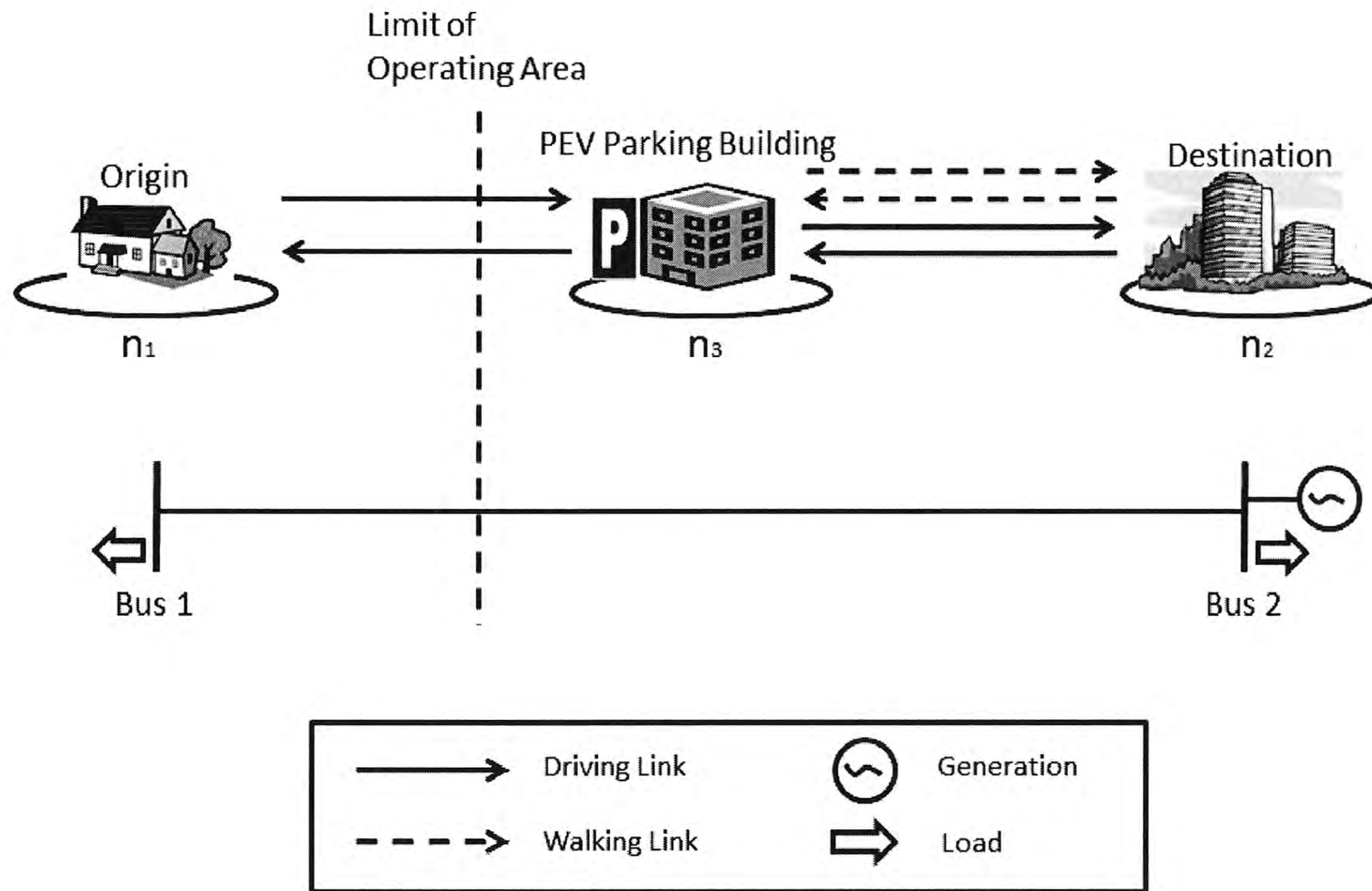
## 4. IMPACT OF PEV ON ELECTRICITY NETWORK

In the future, PEV parking facilities could be an important place for exchange of electric power. Parking building developers could have an opportunity to gain revenue not only from the parking fees and charging services, but also by acting as an aggregator in electricity markets. A PEV parking building uses electricity for charging services and generates electricity from PEV batteries for ancillary services. This chapter investigates the impact of PEVs on traffic flow and micro-level power system configurations, such as a nodal area, from a parking garage developer's perspective. The model in this chapter is an extension of the previous PEV parking development model in which market electricity price are considered as parameter.

The next section will present an overview of the problem and the key assumptions. Section 4.2 presents mathematical formulations of the model. A simple numerical example showing the impact of PEVs and the total revenue model is provided in Section 4.3.

### *4.1 Problem Description*

Generally, a bus in a power network represents the smallest unit where power transaction is conducted. A bus could be associated with one or more nodes placed within an operating area. Figure 4.1 shows a schematic representation of a power and a transportation network with a PEV parking building. While node 1 is within the operating area of bus 1, node 2 and node 3 are within the operating area of bus 2.



**Figure 4.1 Schematic Representation of the Networks with a PEV Parking Building**

In the transportation network, both node 1 ( $n_1$ ) and node 2 ( $n_2$ ) have conventional parking garages where both ICEVs and PEVs can be parked. Node 3 ( $n_3$ ) indicates the PEV parking building where PEVs can be charged or discharged. PEV drivers would choose a parking garage between node 2 and node 3 based on parking fare and walking distance. In node 3, batteries in PEVs could be charged or discharged. That is, the PEV parking building on node 3 could be a power load or generator within the operating area of bus 2. Given this schematic representation, the developer of the PEV parking building needs to make the optimal location and parking fare decisions that would maximize the total revenue.

In this section, key assumptions are defined for clarity of the model presentation. For the transportation network problem, the three assumptions defined in Section 3.1 are used as well. For the electric power network problem, the following three assumptions are defined for model formulation:

- Minimum MW contract size is not considered.
- Power load is the sum of the total power consumption within an operating area.
- Movement of people between each operating area is accomplished only through vehicles.

## 4.2 The Model

This section presents the formulation of the network design problem and power system operations. First, the formulation of the network design problem explains how a developer's decision regarding location and incentives affects drivers' travel choice and a PEV parking demand. Second, the formulation of power system operations accounts for the relationship between power system operating conditions and traffic flow of PEVs.

For this study, a directed transportation network  $G(N, A)$ , with a set  $N$  of nodes and a set  $A$  of links, was considered. Set  $A$  consists of two subsets of links: driving and walking,  $A_D$  and  $A_W$ , respectively. The network includes  $k$  origin-destination pairs  $(r_i, s_i)$ ,  $r_i, s_i \in N$ ,  $i = 1, \dots, k$ .

Furthermore, a power system network with  $M+1$  buses and  $L$  branches,  $P(M, B)$ , was considered. The set of buses are denoted by  $M \sqcup \{0, 1, 2, \dots, M\}$ , with the slack bus at bus 0, and the set of branches connected between buses are denoted by  $B \sqcup \{b_1, b_2, \dots, b_L\}$ .

### 4.2.1 Network Design Problem

The objective functions of network design problems for a PEV parking building are formulated as follows, and constraints can be found in Section 3.2.

$$\max_{l,i} r_{Total}(l,i) = r_{PF}(l,i) + r_{RS}(l,i) + r_{PH}(l,i) \quad (4.1)$$

$$\max_{l,i} r_{Total}(l,i) = r_{PF}(l,i) + r_{CH}(l,i) \quad (4.2)$$

A developer of a PEV parking building seeks to maximize profit by constructing a parking garage using the optimal location and parking fare policy. A developer's decision on location ( $l^*$ ) and incentive ( $i^*$ ) affects the PEV parking demand and the power system conditions, which then changes the developer's revenue. This study proposes two business models for the PEV parking building: one for the V2G mode and another for the G2V mode. The total revenue for the V2G mode is defined as the sum of the parking fee (disincentive), regulation service fee, and peak demand service fee, as shown in Equation 4.1, while the total revenue for the G2V mode is the sum of the parking fee and charging service fee, as shown in Equation 4.2. Three revenue components, including parking fee, regulation service fee, and peak demand service fee, were already defined in Section 3.2.2. Here, the fourth revenue component, the charging service fee, is defined as follows:

$$r_{CH}(l,i) = \sum_{h=1}^{24} \left( (P_{D,SG})_h \cdot f_c - (P_{D,SG})_h \cdot \hat{Z}_h \right) \quad (4.3)$$

where,  $P_{D,SG}$  is a power load from a PEV parking building and  $f_c$  is a charging fee for PEVs.

#### 4.2.2 Power System Operating Conditions

Locational marginal price (LMP) is the cost of providing the next increment of demand at a specific node (Ott 2003). Different LMPs between buses are generally caused by power system operating conditions, such as transmission system, generation, and load. As mentioned in assumptions, traffic flow of PEVs and movement of people could change power system operating conditions, which results in changing LMPs on buses. The model presented in this section addresses LMP problem based on V2G and G2V operations of PEV parking building.

##### 4.2.2.1 Power Generation and Load of PEV Parking Building

The amount of power generation and load of a PEV parking building is determined by the number of parked PEVs (or PEV parking demand [ $d_h$ ]). PEV parking demand varies depending on amount of traffic flow. Generally, the PEV parking demand during the day is higher than at night, as seen in Figure 3.3. Based on PEV parking demand, the effects of PEV parking demand on power generation and load are evaluated.

In the V2G mode, a PEV parking building provides both regulation service and peak demand service. Regulation service corrects unintended fluctuations of power generation in order to meet a load demand. The service could be called upon 400 times per day as “regulation up” or “regulation down”. The regulation reserve equals around 1.5% of the peak demand in a regional area. However, in this study, it was assumed that regulation service demand is not affected by PEV parking building. On the other hand, for peak hour service, the manager of a PEV parking building can contract with the ISO to sell electric power for a specific period. The manager needs to define power extraction ratio to prevent PEV batteries from being drained out. For example, if the developer of a PEV parking building extracts the entire electric power stored in PEVs for peak demand service, batteries in PEVs would be drained. Therefore, it is essential to define a proper power extraction ratio ( $\lambda$ ).

Power generation and load from a PEV parking building,  $P_{G,SG}$  and  $P_{D,SG}$ , are derived from available PEVs and discharging and charging rates:

$$(P_{G,SG})_h = d_h^{**}(l,i) \times P \quad (4.4)$$

$$(P_{D,SG})_h = d_h(l,i) \times C \quad (4.5)$$

where,  $d_h^{**}(l,i) = \lambda(d_h^{***}(l,i) - d_h^*(l,i))$ ,  $d_h^{***}(l,i)$  is the largest number of PEVs between 8 a.m. and 8 p.m.,  $d_h^*(l,i)$  is the fewest number of PEVs for 24 hours, and  $C$  is the charging rate.

#### 4.2.2.2 Power Load on Buses

Population at origin and destination nodes,  $pop_r$  and  $pop_s$ , can be expressed based on trip rates:

$$\begin{aligned} (pop_r)_h &= (pop_r)_{Total} \\ &\quad -\eta \times \left[ (q_j^{rs})_h + (q_k^{rs})_h - (q_w^{sr})_h - (q_y^{sr})_h \right] \forall r, s \end{aligned} \quad (4.6)$$

$$\begin{aligned} (pop_s)_h &= (pop_s)_{Total} \\ &\quad +\eta \times \left[ (q_j^{rs})_h + (q_k^{rs})_h - (q_w^{sr})_h - (q_y^{sr})_h \right] \forall r, s \end{aligned} \quad (4.7)$$

where,  $(pop_r)_{Total}$  is the total population in an origin node,  $(pop_s)_{Total}$  is the total population in a destination node, and  $\eta$  is the average number of passengers. Details on the trip rate can be found in Section 3.2.1.

Based on the current population, power load in node  $i$ ,  $P_{D,i}$ , can be expressed as follows:

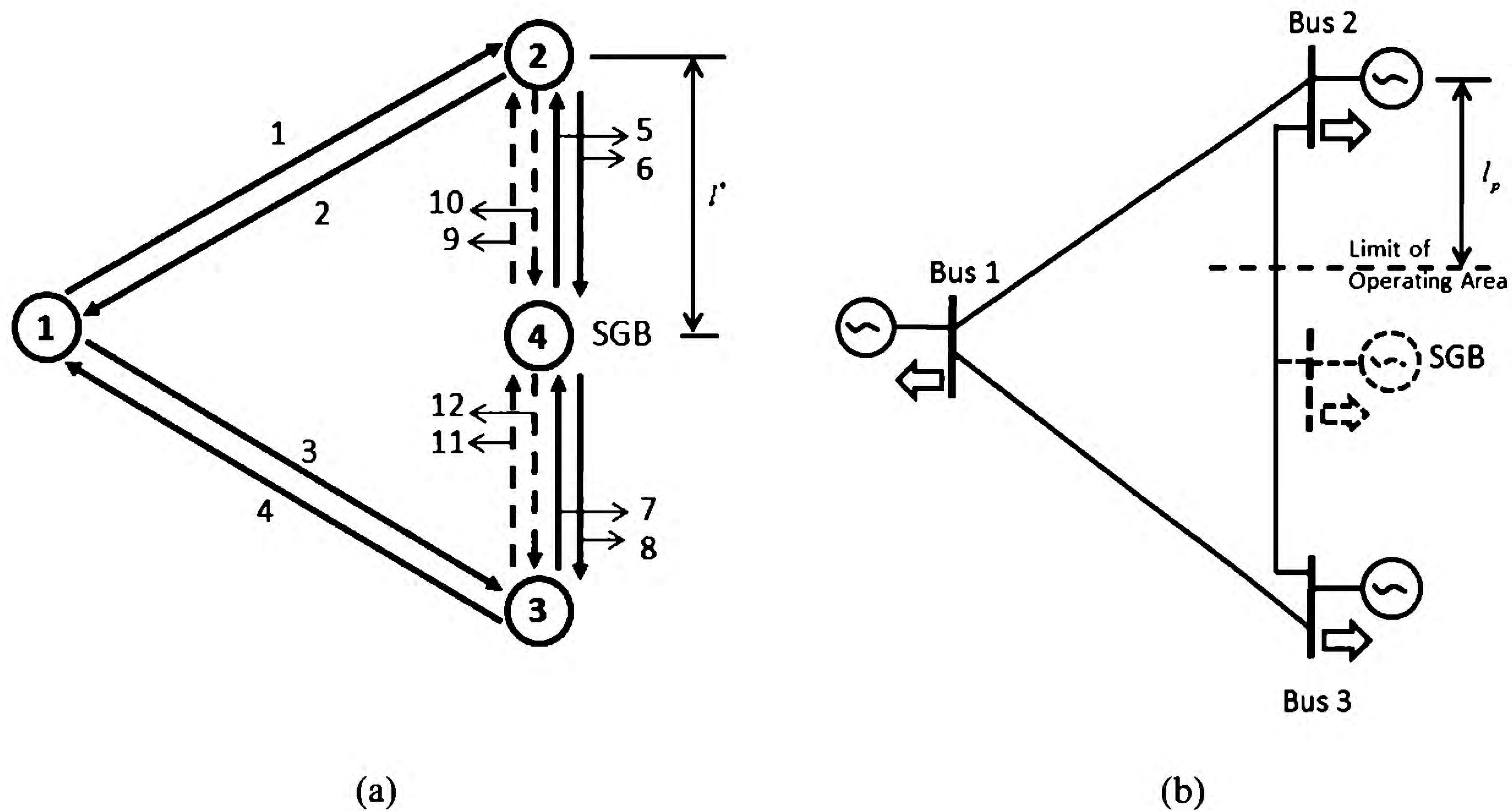
$$(P_{D,i})_h = \kappa_h \times P_{ave} \times (pop)_h \quad (4.8)$$

where,  $P_{ave}$  is the daily average power consumption per person and  $\kappa_h$  is the ratio of power consumption on time  $h$  to power consumption for one day.

### 4.3 Computational Study

#### 4.3.1 Simple Network

Figure 4.2 shows the following examples: (a) a transportation network with four nodes and twelve links, and (b) a power network with three buses and three branches. For the transportation network example, it is assumed that node 1 is the origin in a residential area, and node 2 and node 3 are final destinations in a central business district. Node 2 and node 3 have a conventional parking garage, and a PEV parking building is constructed on node 4, with a distance  $l^*$  from node 2. For the power network example, each bus has a unique power source and load. Bus 2 and bus 3 have their own operating area, and the operating area is divided by the limit of the operating area, with distance  $l_p$  from bus 2.



**Figure 4.2. Example Networks**

For the transportation network, each link has its own parameters for length and capacity. Details on the parameters can be found in Section 3.3.1.

For the power network, it is assumed that three buses and three branches have equal reactances of 0.10 p.u. and the real power flow on branch 2-3 is limited to 0.05 MW. The power network has three generators. Table 4.1 shows the assumed properties of each generator. The generator offers are assumed to be in the form of a linear function. For simplicity, voltage loss and limit are not considered (Louie and Strunz 2008).

**Table 4.1 Generation Data for Example Network**

Generation Bus	Generation Cost (\$/MW)	Max. of Generation (MW)	Min. of Generation (MW)
1	20	20	0
2	25	5	0
3	30	5	0

In addition, the limit of operating area ( $l_p$ ) is assumed to be 1 km from bus 2. The charging and discharging rates for PEVs are assumed as 1.4 kW and 20 kW, respectively (Parks, Denholm, and Markel 2007; Kempton 2007). The initial population on the residential area (node 1) is assumed as 15,000, and initial populations on the CBDs (node 2 and 3) are assumed as 1,500 and 2,000. The optimal power flow problem and locational marginal prices were computed using MatPower 3.2 (Zimmerman et al. 2011).

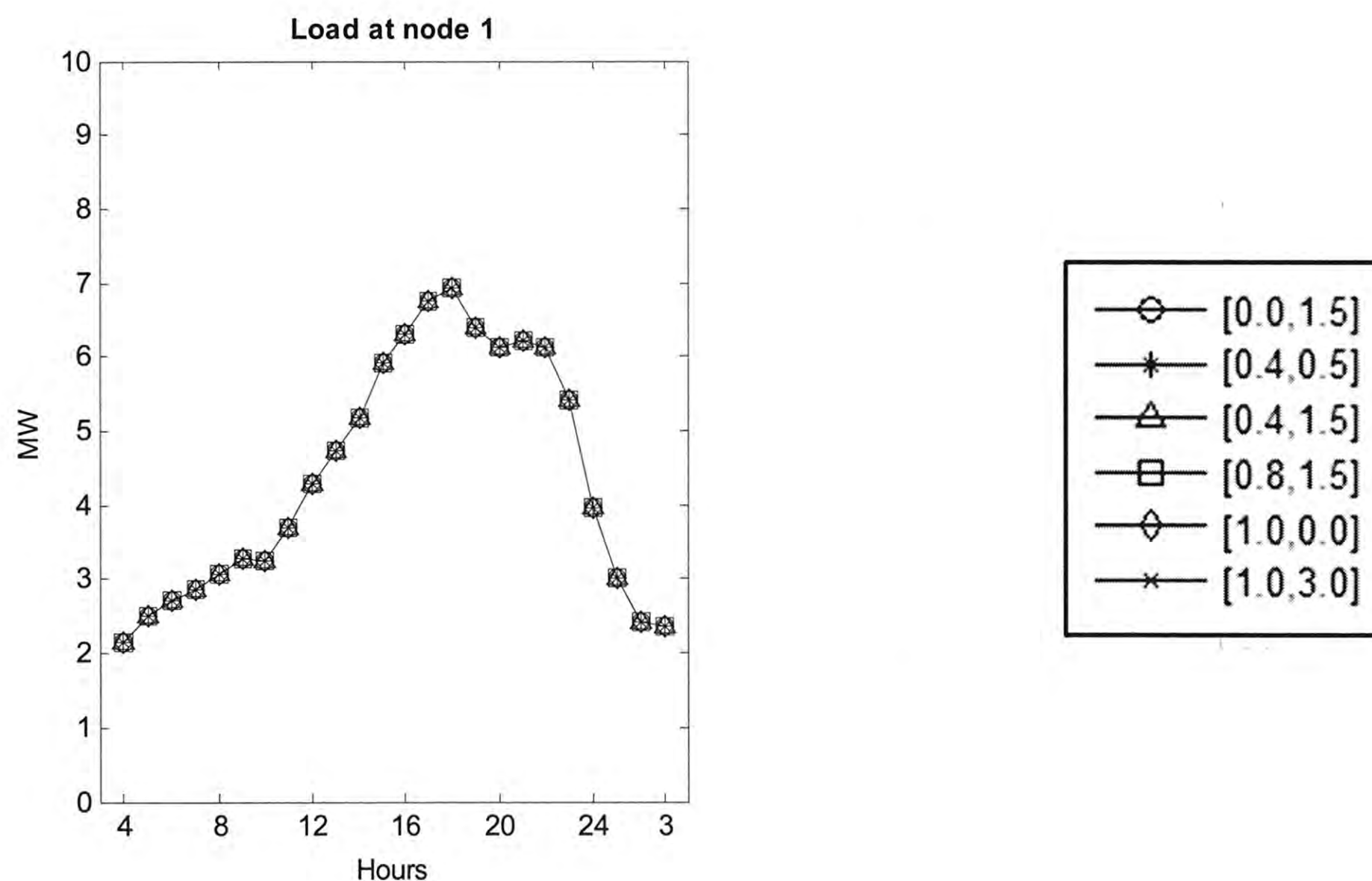
### 4.3.1.1 Results for Impact of V2G and G2V

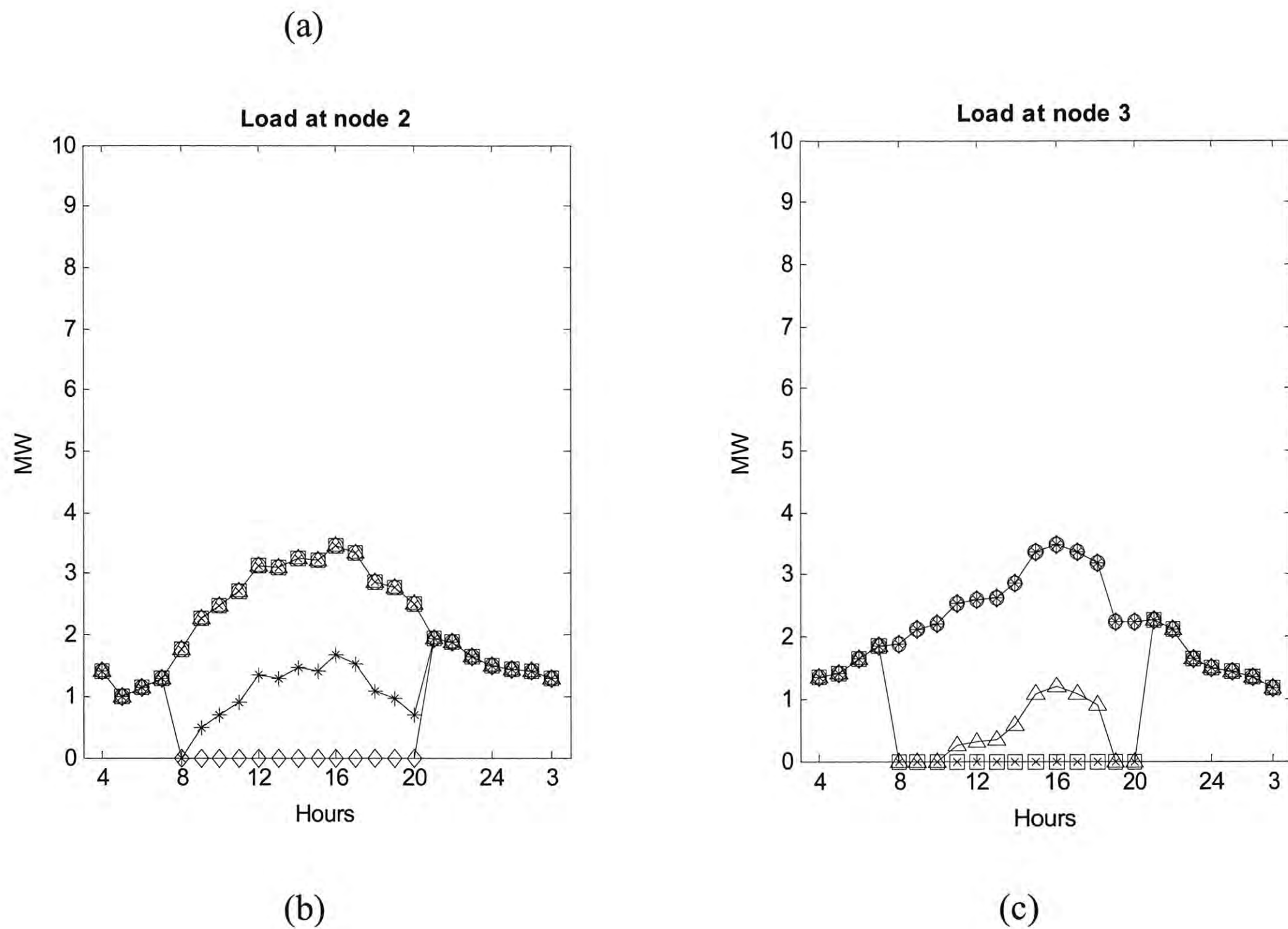
This section presents the impact of V2G and G2V modes of new PEV parking building on electric power network. The impact is investigated with variations of electric power generation, load, and LMP on each bus. Generation, load, and LMP without PEV parking building can be found in APPENDIX D.

#### - Impact of V2G

Electric power stored in PEVs is used for peak hour service in the V2G mode. Therefore, electric power extracted from a PEV parking building reduces a power load from 8 a.m. to 8 p.m. Figure 4.3 and Figure 4.4 show load and generation on each bus. In the figure's legend, the first value in the parentheses indicates the amount of incentive, and the second value indicates the location of the PEV parking building.

Depending on the developer's decision, the PEV parking building would be located either within the operating area of bus 2, or bus 3. In Figure 4.3(b), the asterisk (\*) and diamond ( $\diamond$ ) lines indicate that the PEV parking building is constructed within the operating area of bus 2 and generates electric power. Therefore, the asterisk and diamond lines are below the top line due to the electric power generation from the PEV parking building. On the other hand, the load on bus 1, as seen in Figure 4.3(a), remains unaffected because the PEV parking building is not located within the operating area of bus 1.

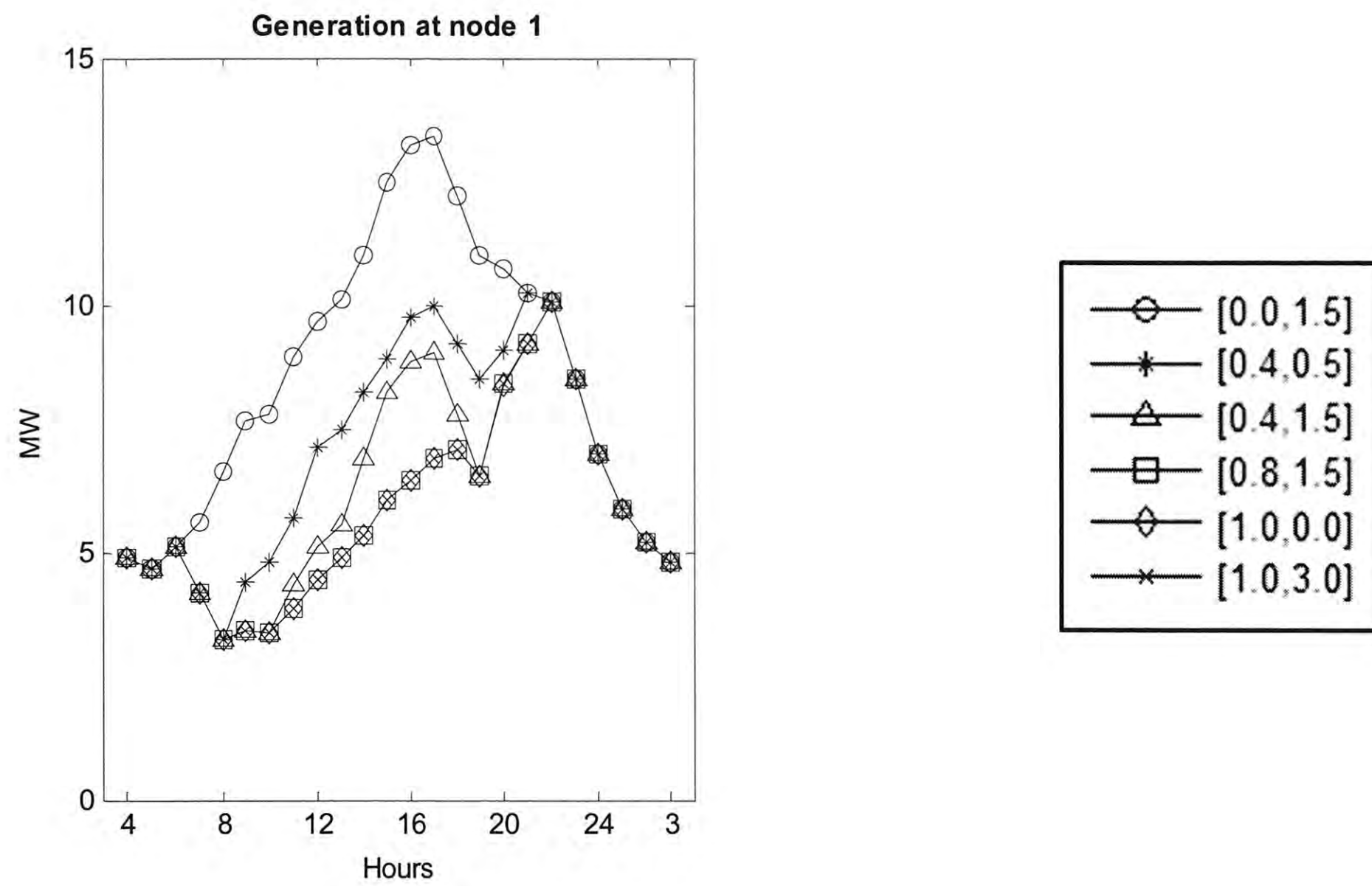




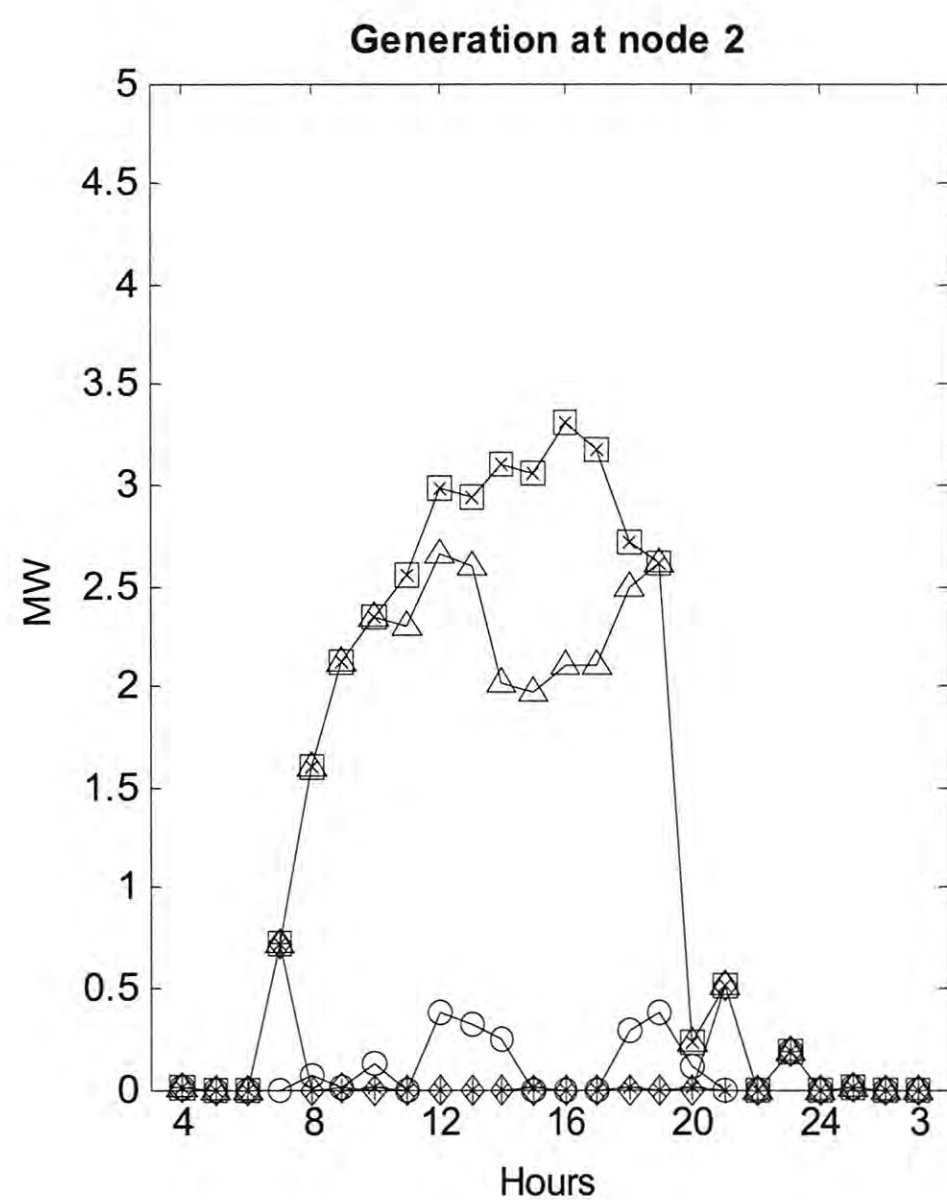
**Figure 4.3. Power Load in V2G.**

In Figure 4.4(a), the circle ( $\circ$ ) line shows a situation when the PEV parking building does not provide any incentive. That is, PEV drivers do not want to park their cars in a distant parking building without incentive, which results in no electric generation from the PEV parking building. In contrast, the diamond and cross ( $\times$ ) lines are the bottom line in Figure 4.4(a) because the PEV parking building is constructed on the final destination nodes and provides incentive of 1 \$/hr.

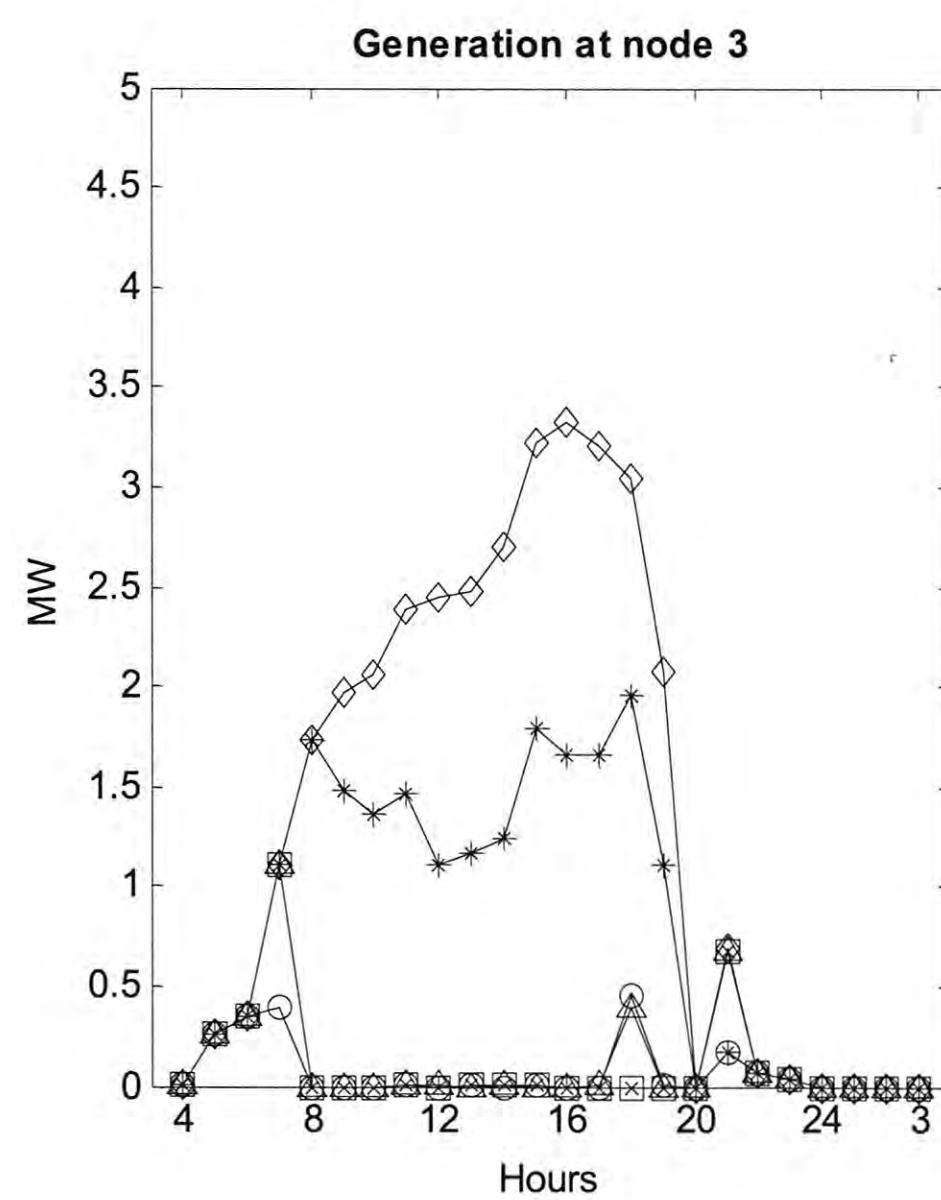




(a)



(b)

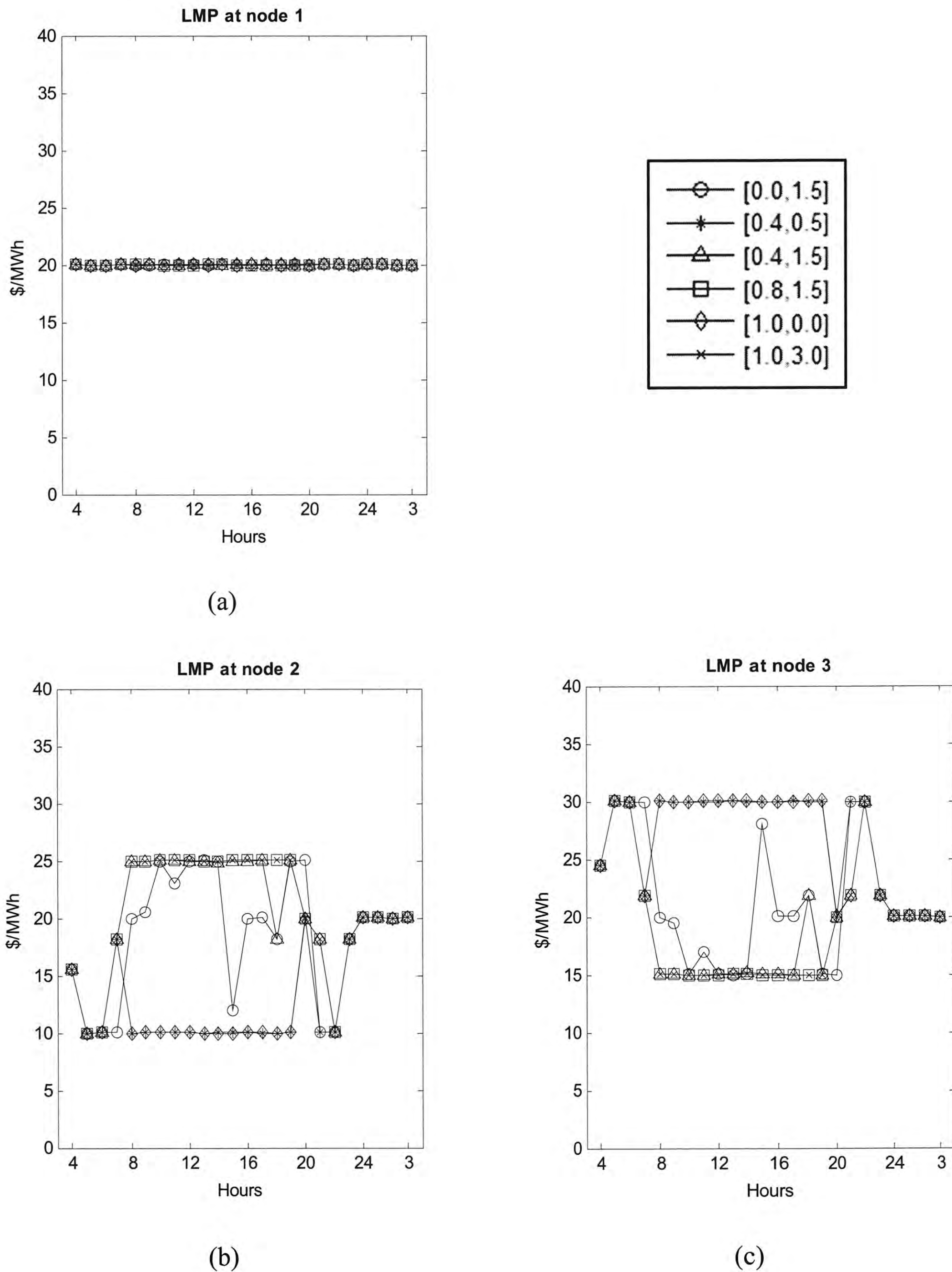


(c)

**Figure 4.4. Power Generation in V2G.**

Based on the power system operating conditions, locational marginal prices are calculated in Figure 4.5. LMPs at bus 1, in Figure 4.5(a), are constant at 20 \$/MW, but LMPs at bus 2 and bus 3, in Figure 4.5(b) and Figure 4.5(c), fluctuate due to insufficient capacity of transmission line. LMP tends to be increased when generation is increased. For example, cross line in Figure 4.4(b) and Figure 4.5(b) shows the trend of LMP depending on power generation. The cross line shows,

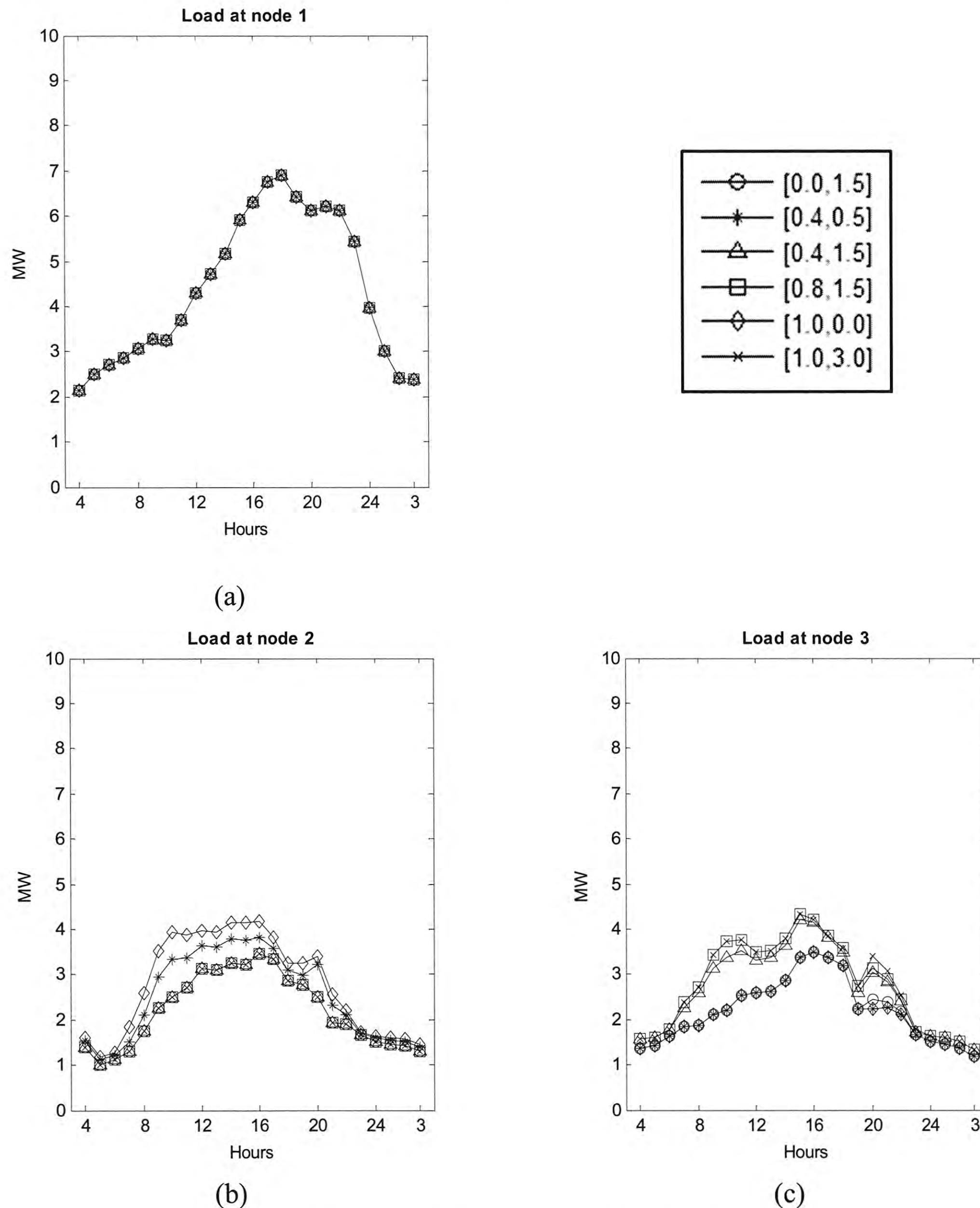
when generator connected on bus 2 is operated to produce electric power, LMP indicates 25 \$/MWh which is generation cost on bus 2 as shown in Table 4.1.



**Figure 4.5. LMP in V2G.**

- *Impact of G2V*

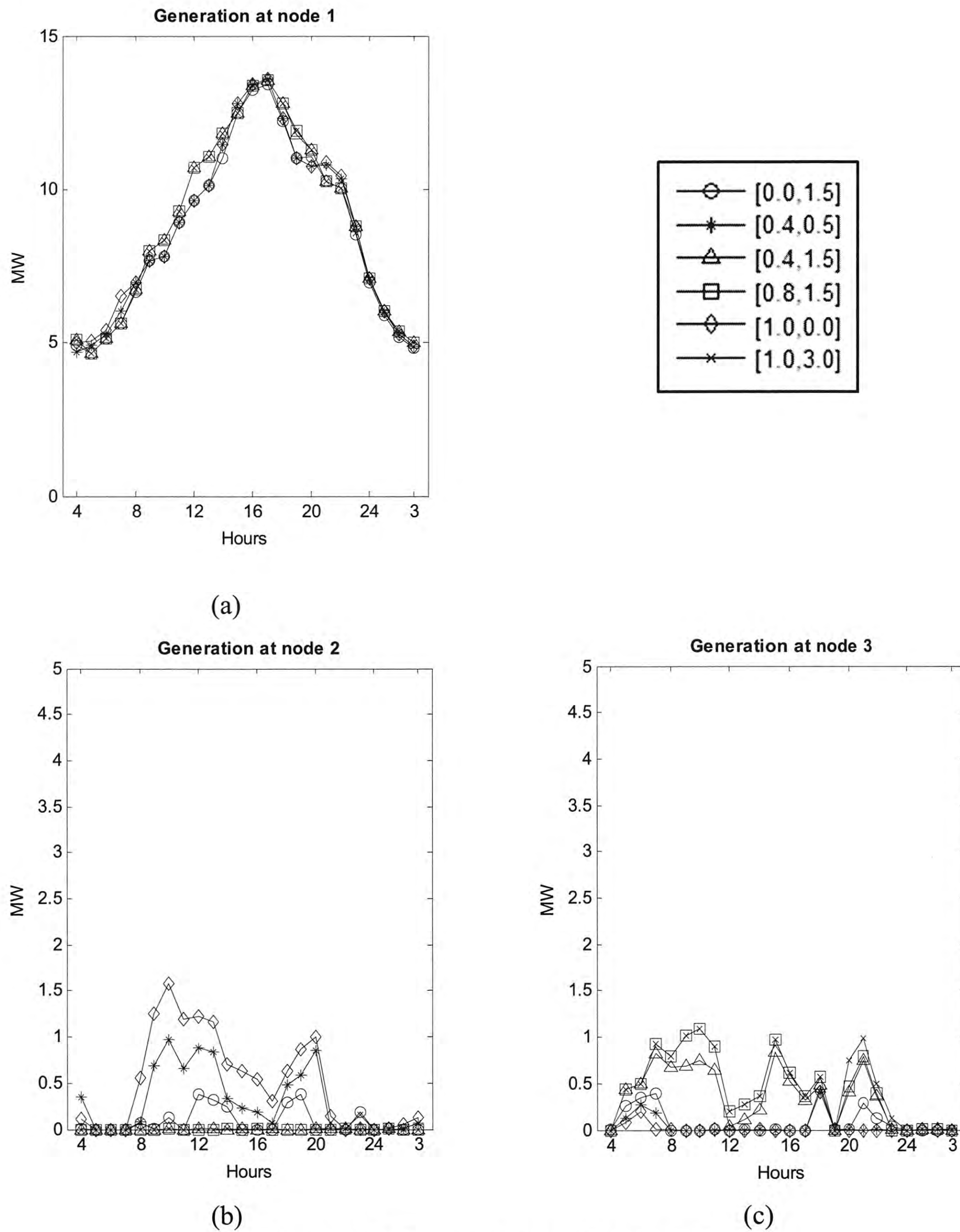
Generally, charging services at a PEV parking building increase the electric power load. Figure 4.6 shows increased electric power loads at bus 2 and 3 where PEV parking building is located. For example, if PEV parking building is located on node 3 and provides the incentive of 1 \$/hr, PEV drivers would park their cars in PEV parking building on node 3. In this situation, load on bus 2, cross line, will be a minimum, but load on bus 3 will be a maximum, which results from that PEV parking building is located with the operating area of bus 3.



**Figure 4.6. Power Load in G2V**

In G2V mode, Figure 4.7(a) shows increased power generation at bus 1. Electric power generations at bus 2 and 3 in G2V mode are less than the generation in the V2G mode because of the absence of power generation from the PEV parking building. In G2V mode, more parked

PEV mean more power demand, which brings more power generation. In Figure 4.7(b), diamond line, which PEV parking building is located on node 2 and provides the incentive of 1 \$/hr, shows generation on bus 2 will be a maximum.



**Figure 4.7. Power Generation in G2V**

Figure 4.8 shows LMP in G2V. Like LMP in V2G mode, LMP in G2V mode also tends to be increased when generation is increased. While LMP at bus 1 where electricity is produced in the

lowest price, shows a constant value of 20 \$/MWh, LMP at bus 2 and bus 3 is fluctuated due to changing power system operating condition.

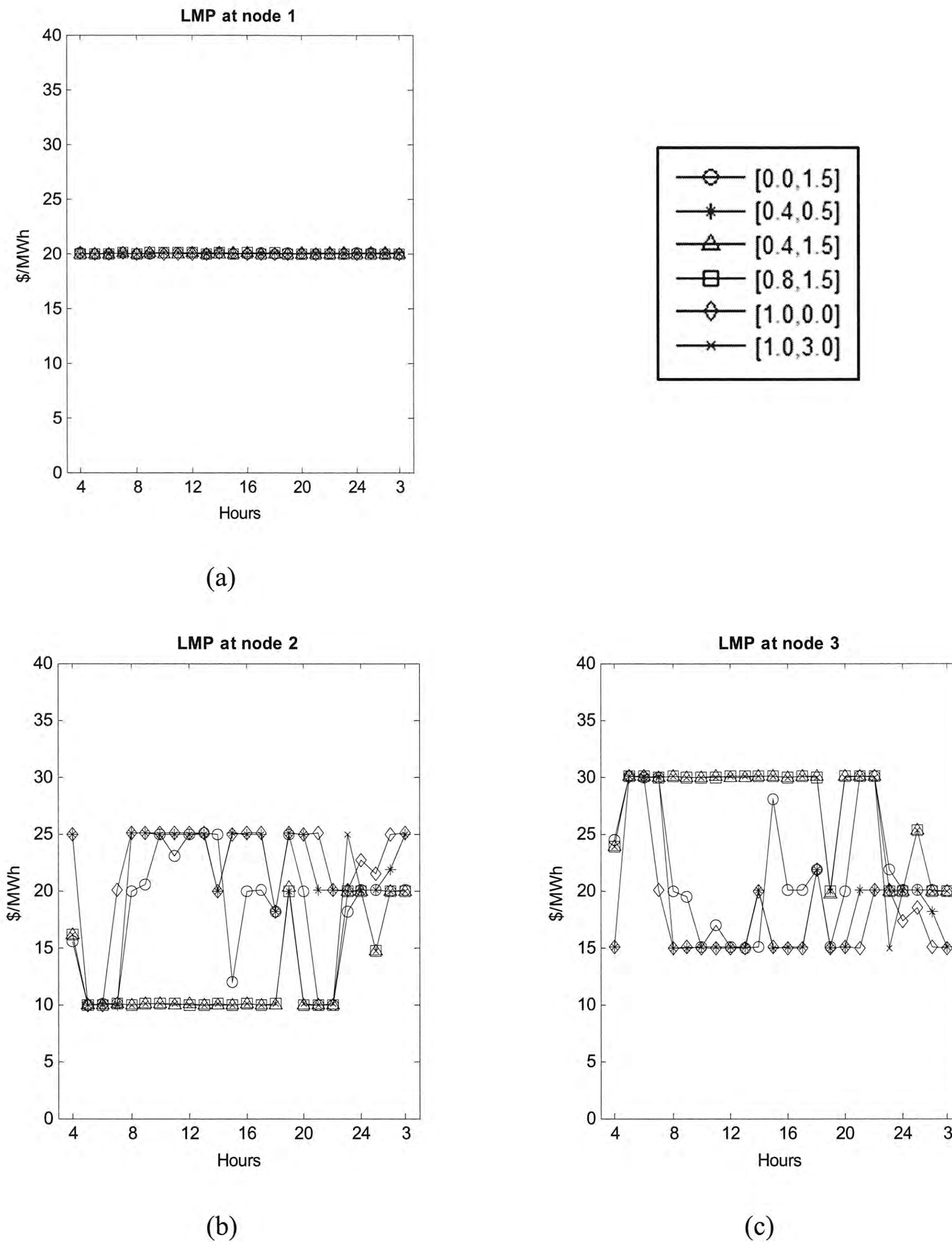
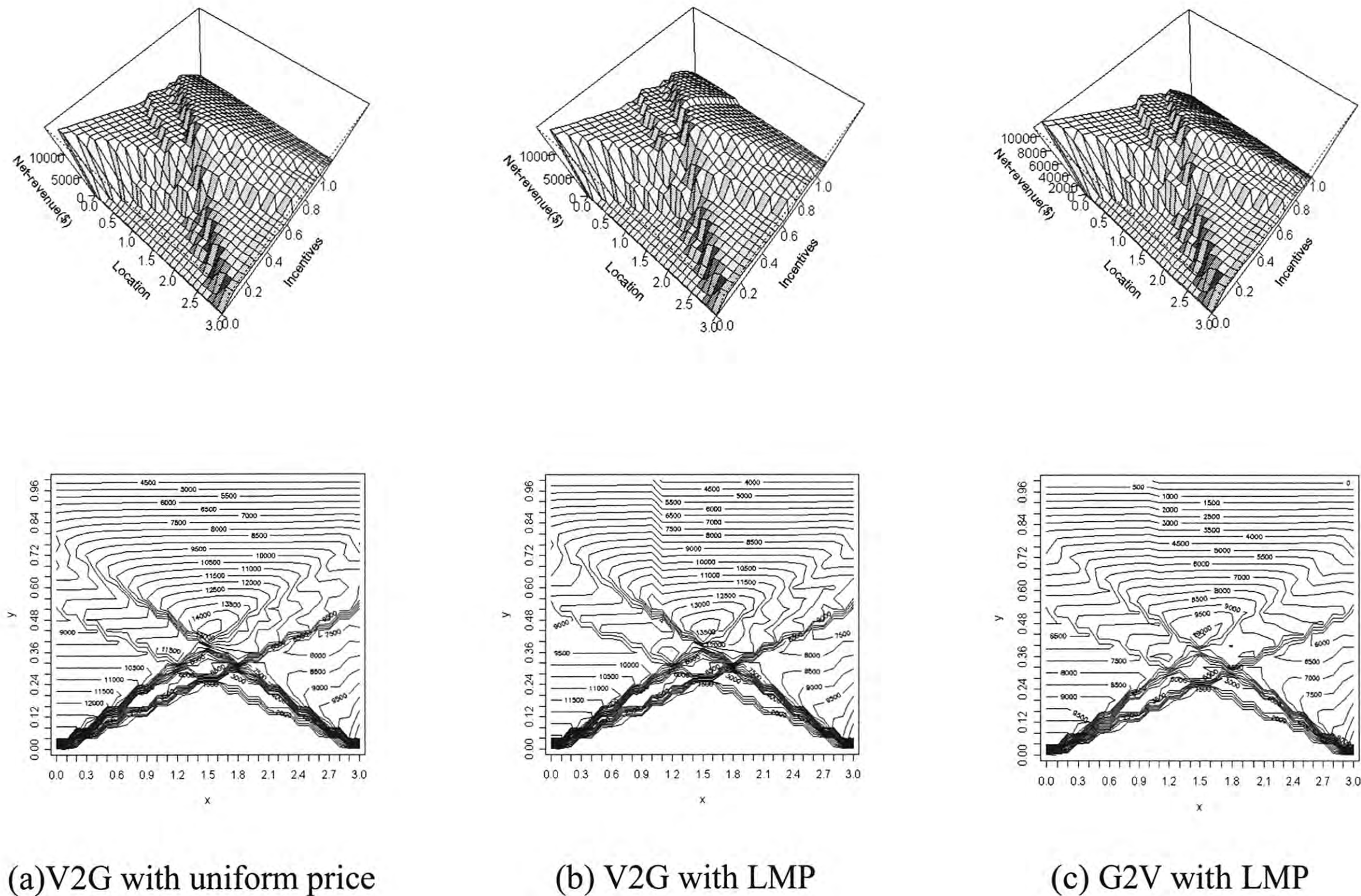


Figure 4.8. LMP in G2V

#### 4.3.1.4 Results for Total Revenues

Figure 4.9 shows the contour graphs for total revenues. Compared to the graph for V2G with a uniform price, the graphs for V2G with LMP and G2V with LMP exhibit discontinuities at the location of 1.0 km, as a result of the impact of the PEV parking building on bus 2 and bus 3. The business model in the V2G mode with LMP makes more profit than the business model in the G2V mode with LMP. While the optimal location and incentive of the PEV parking building are determined at similar points in all cases, the amounts of total revenues are different due to different types of business and power price.

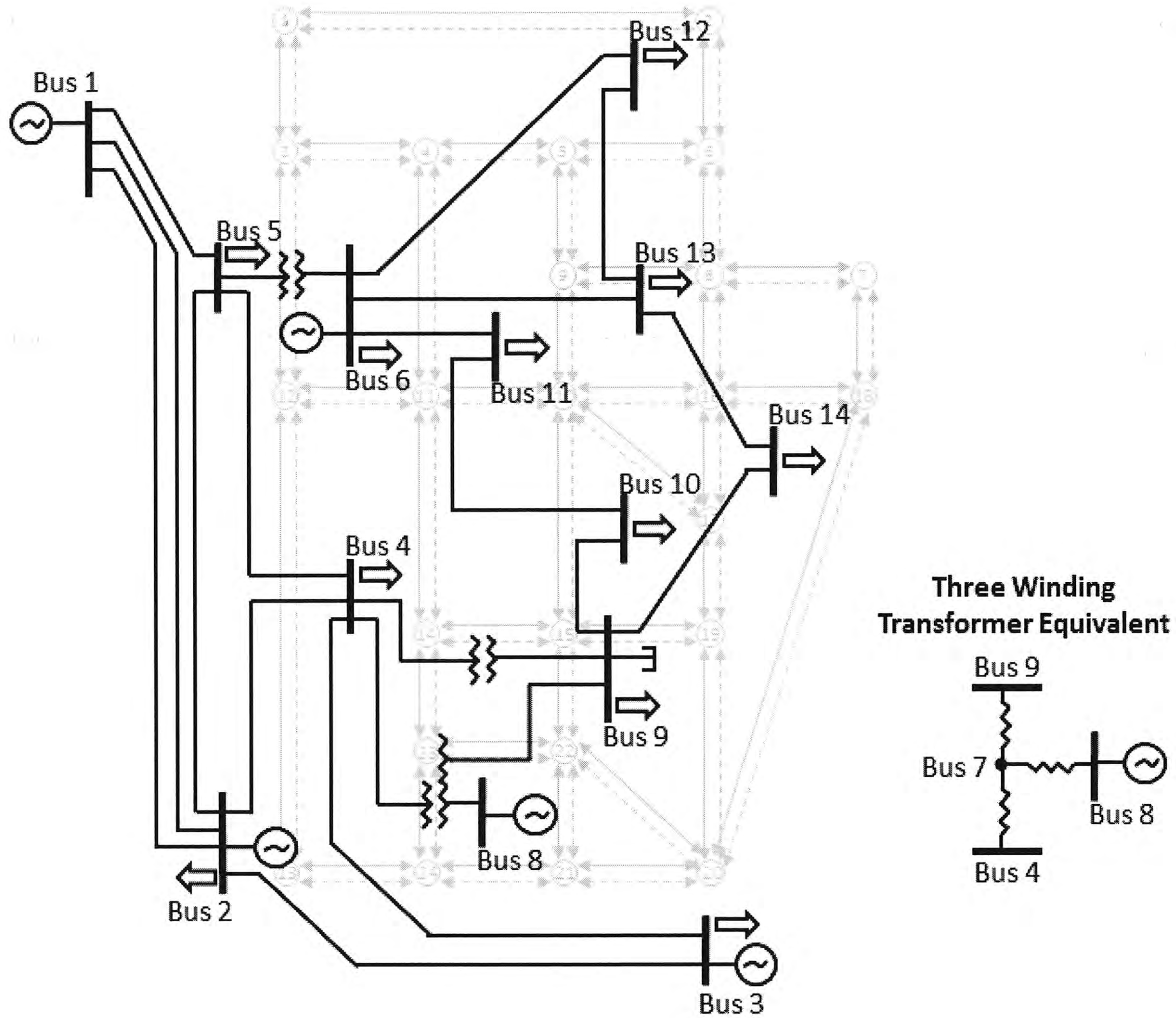


**Figure 4.9. Surface and Contour Graphs for Total Revenues**

#### 4.3.2 Large Network

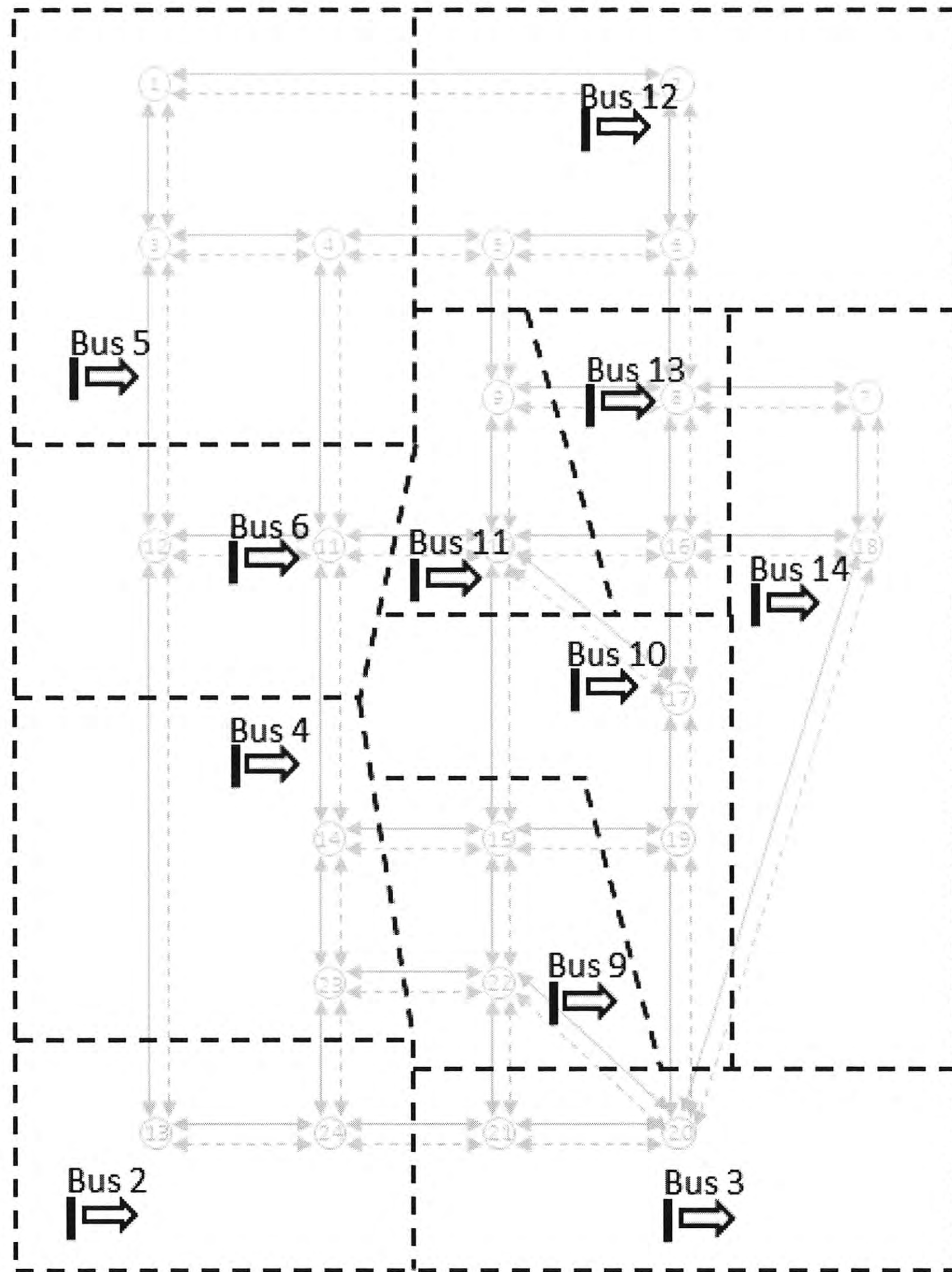
The model proposed in this chapter is applied next to a large network, Sioux Falls network which is already shown in Chapter 3. Electric power network is required to investigate the impact of PEV parking building. As it is difficult to find real electric power network due to public security, IEEE 14 bus test system (Pierce et al. 1973) is imposed for this large transportation network. The IEEE 14 bus test system data consists of bus, generator, branch data and generation cost data, but does not contain information of spatial location of buses (i.e. distance between buses). IEEE 14 buses are defined to be located on transportation network in Sioux Falls as shown in Figure 4.10. Original IEEE 14 bus system has two generators on bus 1 and bus 2, and three synchronous

condensers on bus 3, bus 6, and bus 8. For this large network, three synchronous condensers are considered as generators.



**Figure 4.10 IEEE 14 Bus Test System on Transportation Network in Sioux Falls**

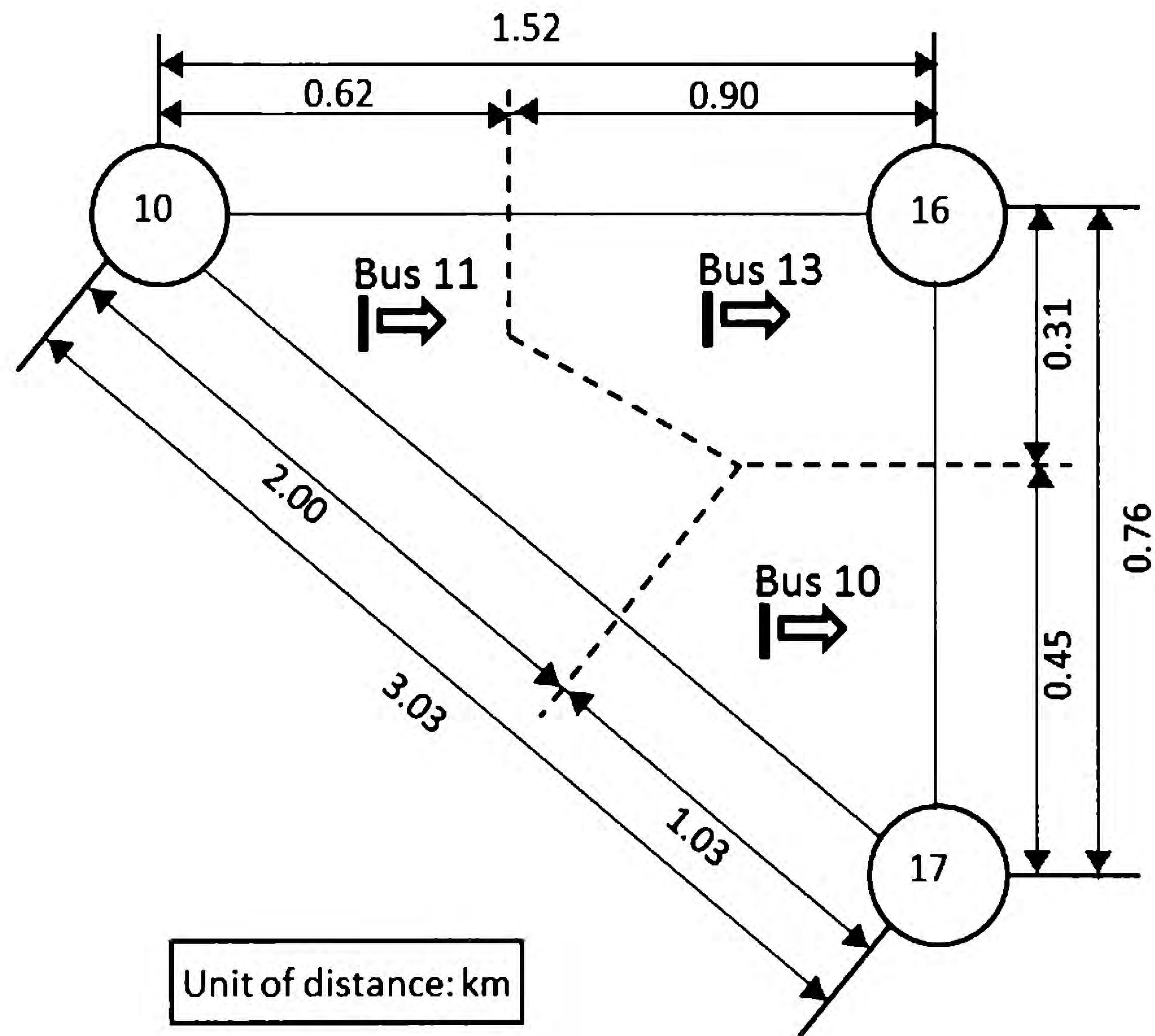
Figure 4.11 shows the operating areas for each bus. It is assumed that three buses where the loads are not connected, bus 1, bus 7, and bus 8, do not have an operating area. The other buses with a power load have their own operating areas as shown in Figure 4.11. For example, bus 2 provides an electric power for node 13 and node 24. Three nodes in CBD, node 10, node 16, and node 17, are located on bus 11, bus 13, and bus 10, respectively.



**Figure 4.11 Operating Areas for Each Bus**

PEV parking building will be connected to specific bus depending on the location in a transportation network. Figure 4.12 shows defined limits of operating areas in transportation network. For example, if PEV parking building is constructed at distance 0.8 from node 10 on the link between node 10 and node 16, PEV parking building would be connected to bus 13.





**Figure 4.12 Limits of Operating Areas in Transportation Network**

Generator data of IEEE 14 bus test system is modified for three additional generators. Table 4.2 shows detail values of modified generator data. Basically, the modified generator data is referred from IEEE 14 bus test system, but values in bold fonts are assumed for this large network. Notation for first row in Table 4.2 can be found in APPENDIX E.

**Table 4.2 Modified Generator Data**

bus	$P_g$	$Q_g$	$Q_{max}$	$Q_{min}$	$V_g$	mBase	status	$P_{max}$	$P_{min}$
1	232.4	-16.9	10	0	1.06	100	1	332.4	0
2	40	42.4	50	-40	1.045	100	1	140	0
3	<b>50</b>	23.4	40	0	1.01	100	1	100	0
6	<b>50</b>	12.2	24	-6	1.07	100	1	100	0
8	<b>50</b>	17.4	24	-6	1.09	100	1	100	0

Transmission lines in IEEE 14 bus test system do not have MVA limits, thus are considered to have limitless transfer capacities. Unlimited capacity results in same LMP at all buses. Therefore, for this large network, the values of 'rateA' in original branch data are significantly reduced from 9900 MVA to around 60 MVA as shown in Table 4.3. Notation for first row in Table 4.3 can be found in APPENDIX E.

**Table 4.3 Modified Branch Data**

fbus	tbus	r	x	b	rateA	rateB	rateC	ratio	angle	status
1	2	0.01938	0.05917	0.0528	<b>65</b>	0	0	0	0	1
1	5	0.05403	0.22304	0.0492	<b>70</b>	0	0	0	0	1
2	3	0.04699	0.19797	0.0438	<b>70</b>	0	0	0	0	1
2	4	0.05811	0.17632	0.034	<b>70</b>	0	0	0	0	1
2	5	0.05695	0.17388	0.0346	<b>70</b>	0	0	0	0	1
3	4	0.06701	0.17103	0.0128	<b>70</b>	0	0	0	0	1
4	5	0.01335	0.04211	0	<b>60</b>	0	0	0	0	1
4	7	0	0.20912	0	<b>60</b>	0	0	0.978	0	1
4	9	0	0.55618	0	<b>55</b>	0	0	0.969	0	1
5	6	0	0.25202	0	<b>65</b>	0	0	0.932	0	1
6	11	0.09498	0.1989	0	<b>60</b>	0	0	0	0	1
6	12	0.12291	0.25581	0	<b>60</b>	0	0	0	0	1
6	13	0.06615	0.13027	0	<b>60</b>	0	0	0	0	1
7	8	0	0.17615	0	<b>65</b>	0	0	0	0	1
7	9	0	0.11001	0	<b>65</b>	0	0	0	0	1
9	10	0.03181	0.0845	0	<b>60</b>	0	0	0	0	1
9	14	0.12711	0.27038	0	<b>65</b>	0	0	0	0	1
10	11	0.08205	0.19207	0	<b>65</b>	0	0	0	0	1
12	13	0.22092	0.19988	0	<b>60</b>	0	0	0	0	1
13	14	0.17093	0.34802	0	<b>60</b>	0	0	0	0	1

For this large network, power generation cost at bus  $i$  is defined as polynomial model as (4.9).

$$C_i(P_{gi}) = c_{i_2} \cdot P_{gi}^2 + c_{i_1} \cdot P_{gi} + c_{i_0} \quad (4.9)$$

Coefficients for each generation bus are referred from generator cost data of IEEE 14 bus test system, and some values are modified as shown in Table 4.4.

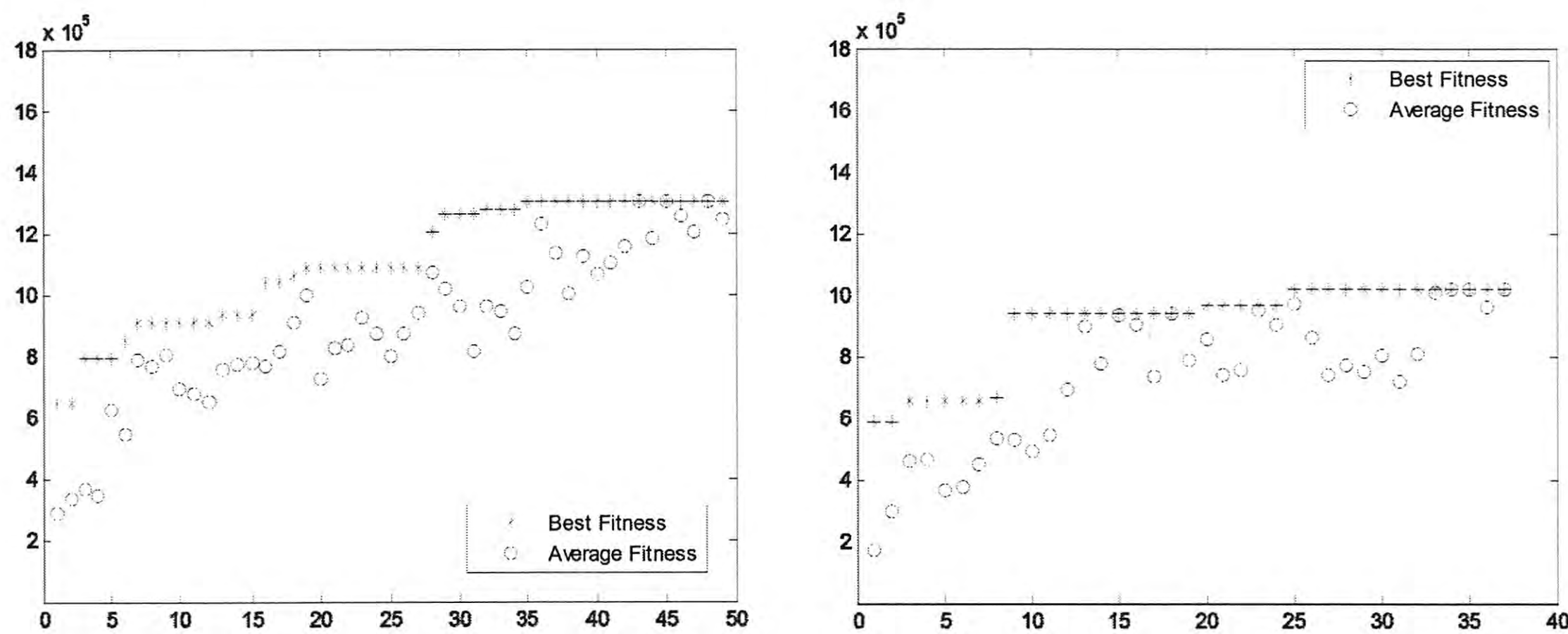
**Table 4.4 Modified Generator Cost Data**

Generation Bus no.	$c_{i_2}$	$c_{i_1}$	$c_{i_0}$
1	0.043	20	0
2	0.250	20	0
3	<b>0.100</b>	<b>30</b>	0
6	<b>0.050</b>	<b>35</b>	0
8	0.010	40	0

The sections first shows the result of the optimal incentive structure, location of PEV parking building, and the total revenues in V2G operation with LMP and in G2V operation with LMP. Next, based on the optimal decisions, the impact of V2G and G2V operations on electric power system is presented in the form of generation, load, and LMP on each bus.

*4.3.2.1 Results—Total Revenues*

Based on the modified IEEE 14 bus test data, PEV parking building model finds the optimal location and incentive structure with V2G and G2V operations. Figure 4.13 (a) and (b), shows the fitness graph of total revenue in V2G operation with LMP and in G2V operation with LMP, respectively.



(a) V2G with LMP

(b) G2V with LMP

**Figure 4.13 Fitness Graphs for Total Revenues**

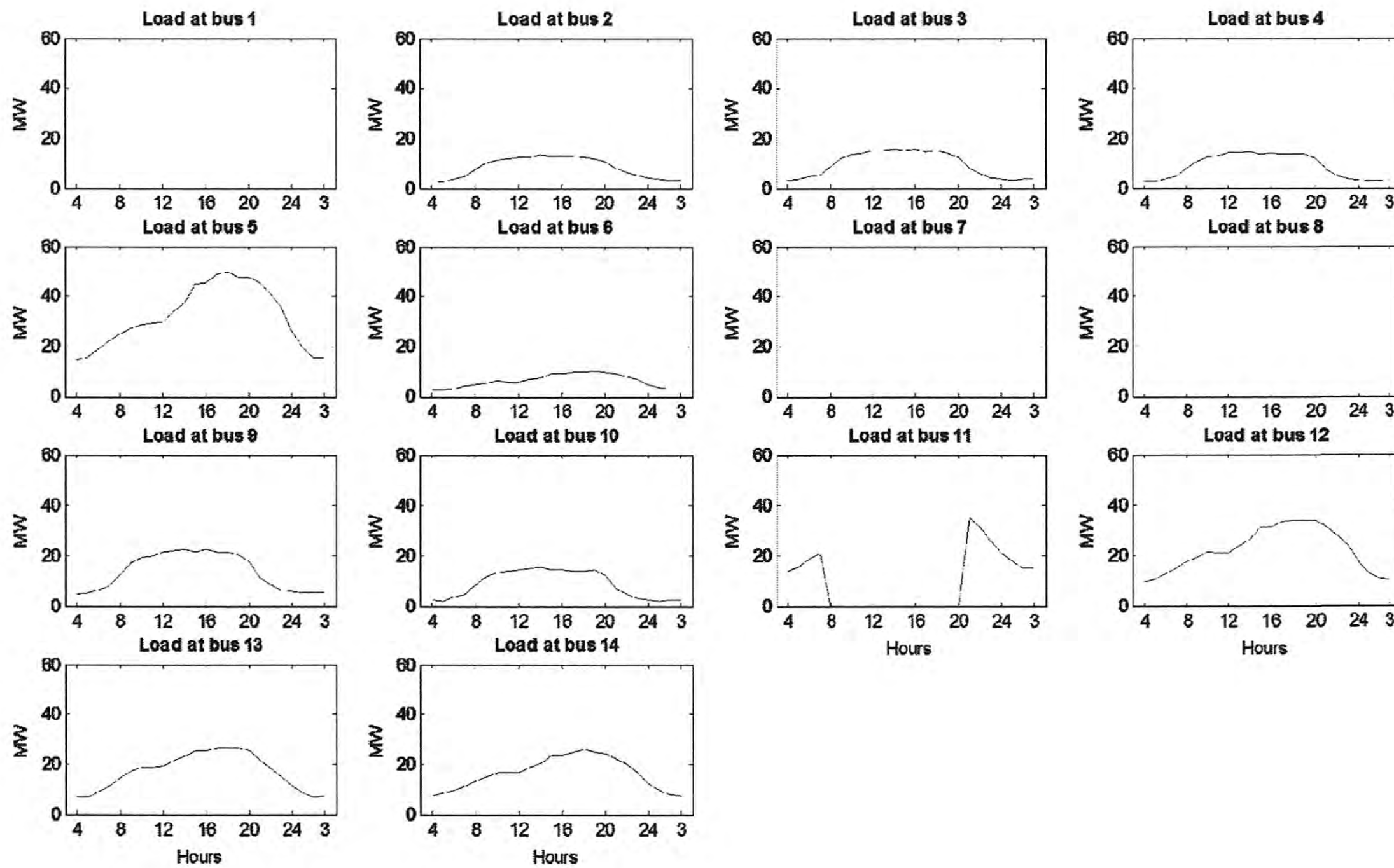
In V2G mode with LMP, GA found the maximized total revenue, which was \$1,301,000. The optimal incentive was approximately \$0.13/hr, and optimal location of PEV parking building was 0.077 km from node 10 on the link between node 10 and node 16. On the other hands, in G2V mode with LMP, the maximized total revenue was found as \$1,017,000, when the optimal incentive was around \$0.16/hr and optimal location was 0.040 km from node 10 on the link between node 10 and node 16.

#### 4.3.2.2 Results—Impact of V2G and G2V

##### - Impact of V2G

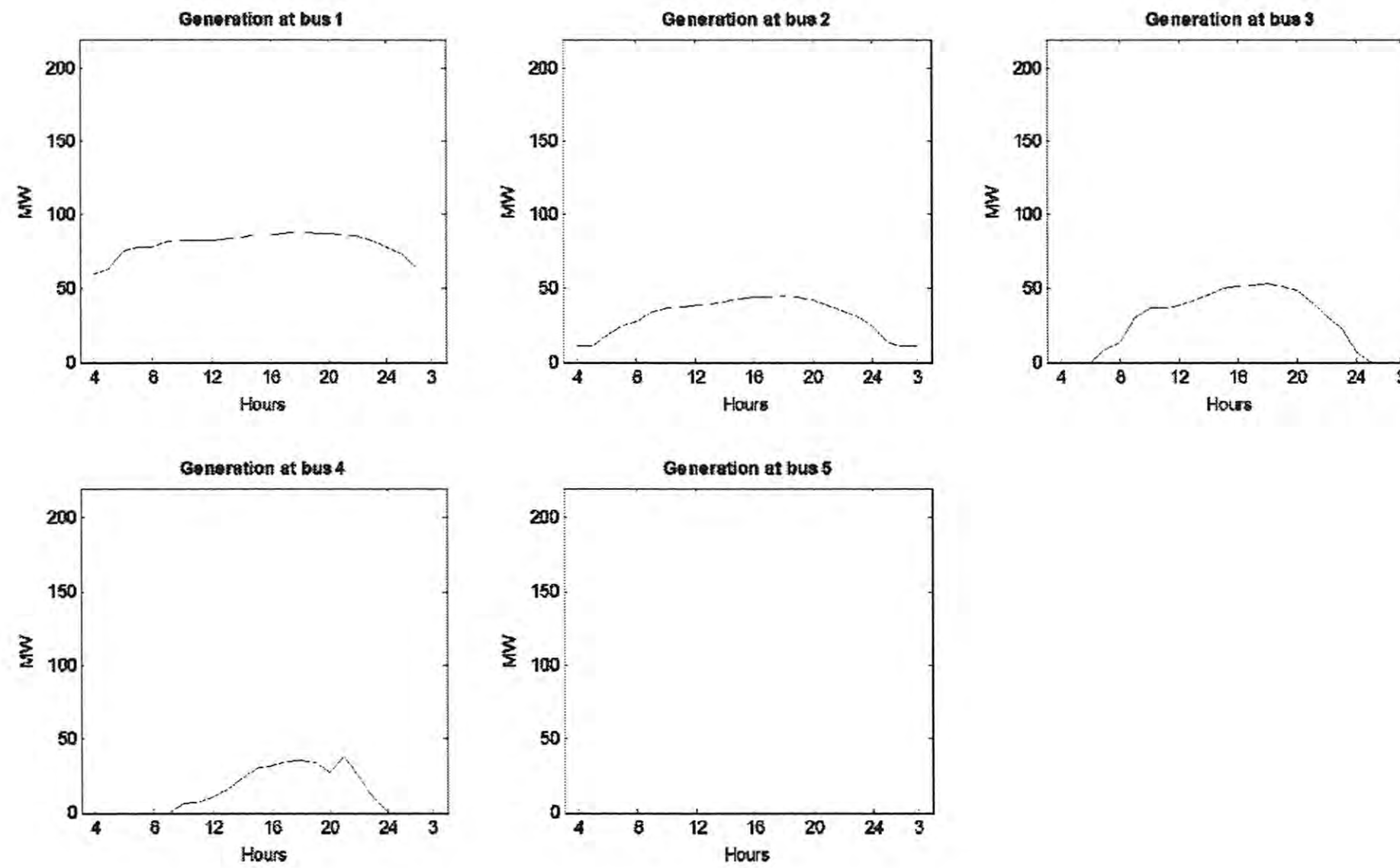
In the previous section, the optimal location of PEV parking building in V2G with LMP is defined as 0.077 km from node 10 on the link between node 10 and node 16. Therefore, the PEV parking building will be located within the operation area of bus 11. Figure 4.14 shows the impact of PEV parking building in V2G mode on electric power system. Bus 11 where PEV parking building provides V2G service, shows reduced electric power load. PEV parking building provides peak power service for bus 11, thus power load on bus 11 is reduced during peak power service hours, from 8 a.m. to 8 p.m.

In Figure 4.14, three buses where the loads are not connected, bus 1, bus 7, and bus 8, do not show any electric power load, while the other buses show normal power load profile, high during business hours and low when people spend less electricity.



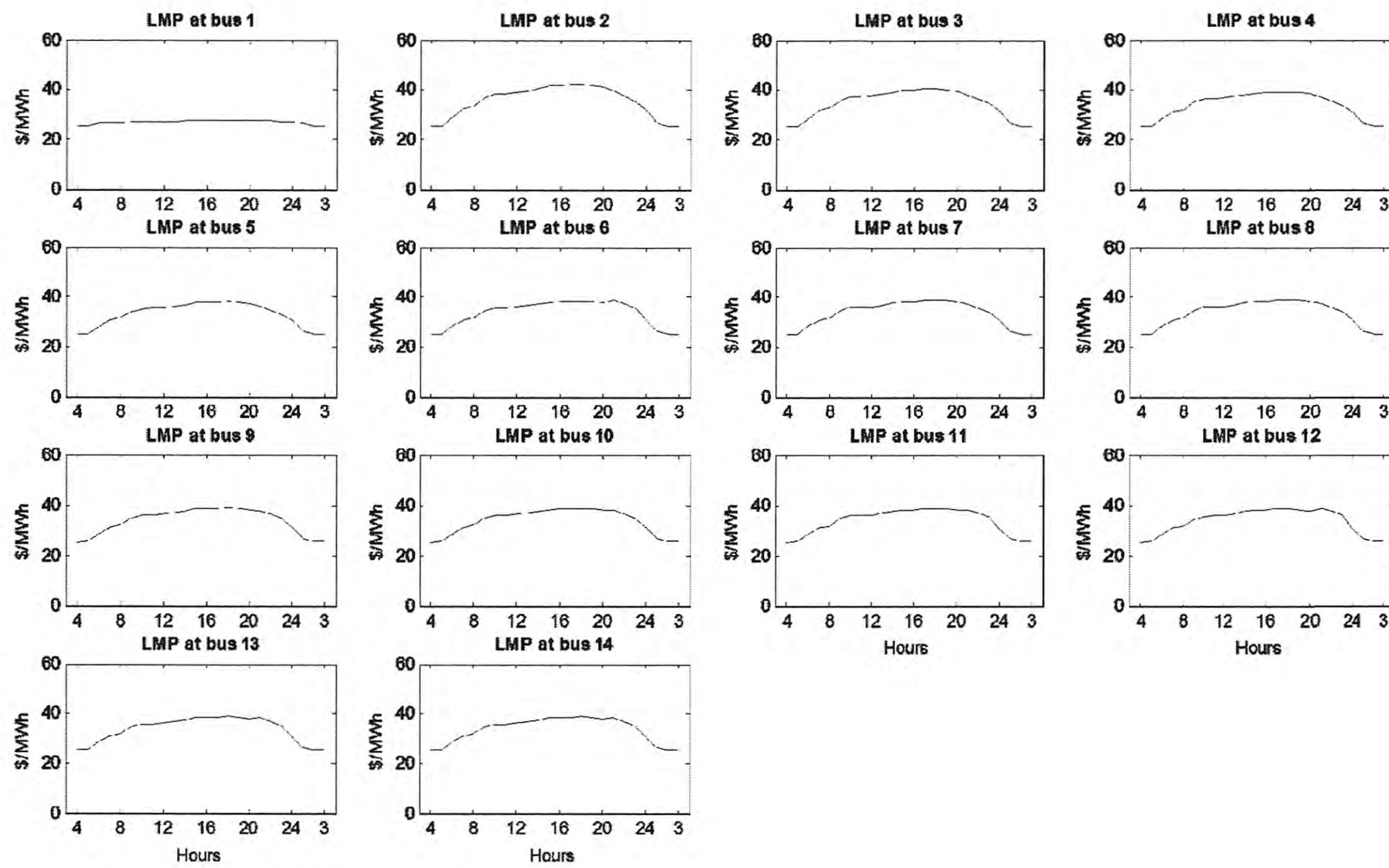
**Figure 4.14 Power Load in V2G of Large Network**

Figure 4.15 shows generation on each generation bus. Bus 1 with cheapest initial generation cost generates the most amount of electricity, while bus 5 with most expensive initial generation cost does not generate any amount of electricity. Bus 3 and bus 4 generate electricity during specific hours when power demand is high.



**Figure 4.15 Power Generation in V2G of Large Network**

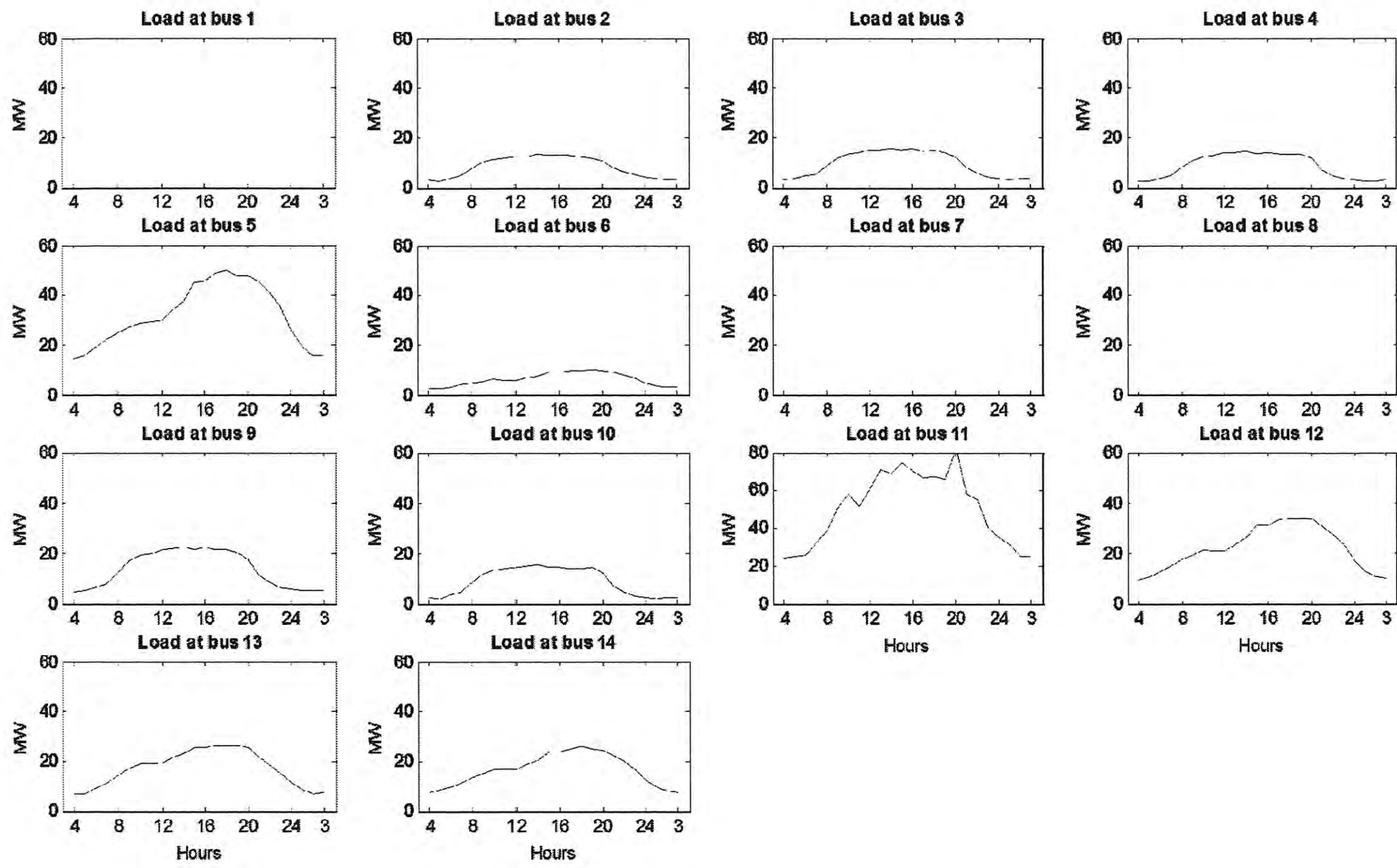
Figure 4.16 shows LMP for one day on each bus. Bus 1 where power generator with the cheapest initial generation cost is installed, presents the lowest LMP. On the other hands, the other bus shows similar LMP patterns, high LMP during business hours and low LMP during a night.



**Figure 4.16 LMP in V2G of Large Network**

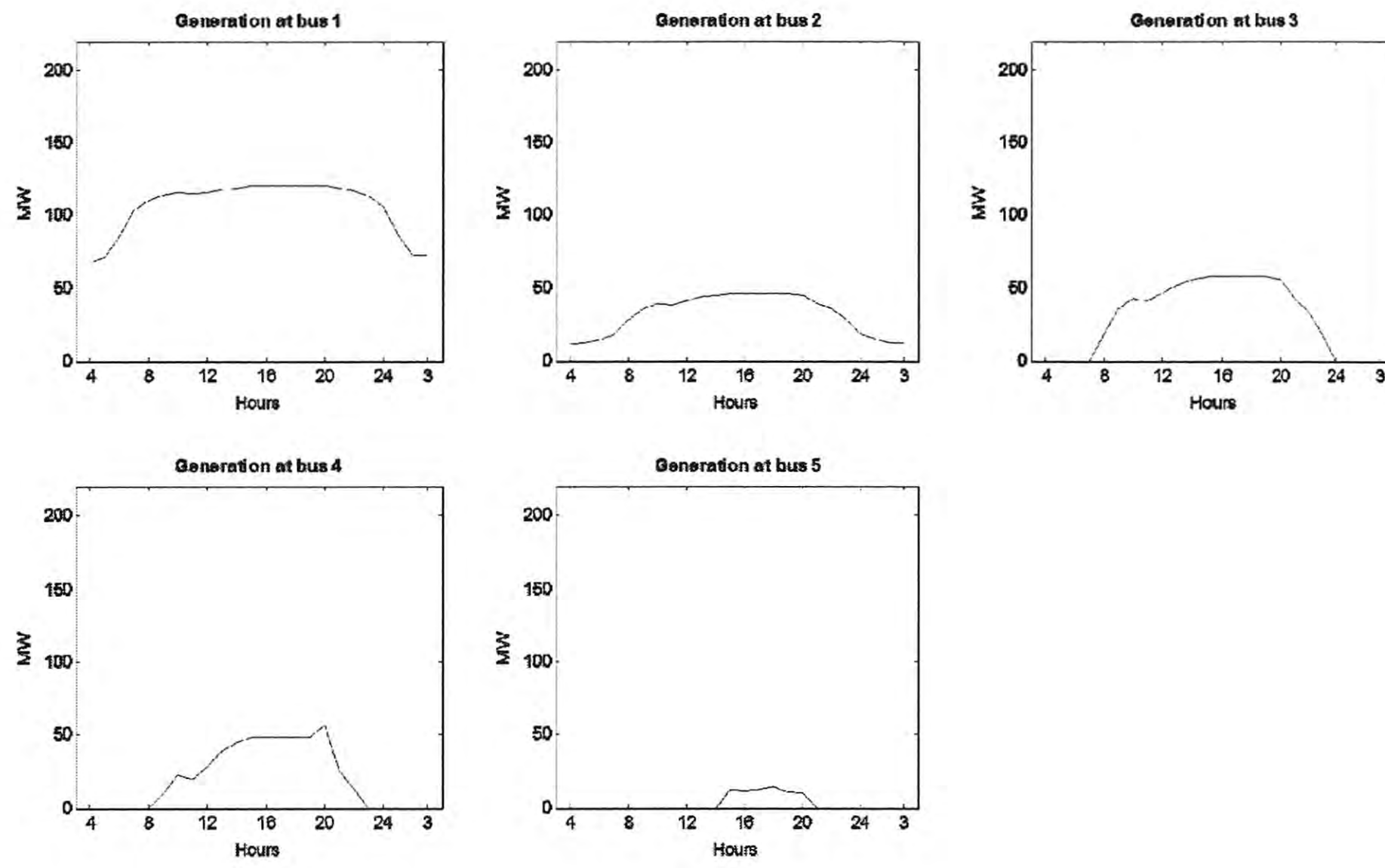
*- Impact of G2V*

In the previous section, the optimal location of PEV parking building in G2V with LMP is defined as 0.040 km from node 10 on the link between node 10 and node 16. Therefore, the PEV parking building will be located within the operation area of bus 11. Figure 4.17 shows electric power load on bus 11 is increased by amount of electricity for charging service from PEV parking demand. The electric power load on the other buses is not affected by the charging service on bus 11.



**Figure 4.17 Power Load in G2V of Large Network**

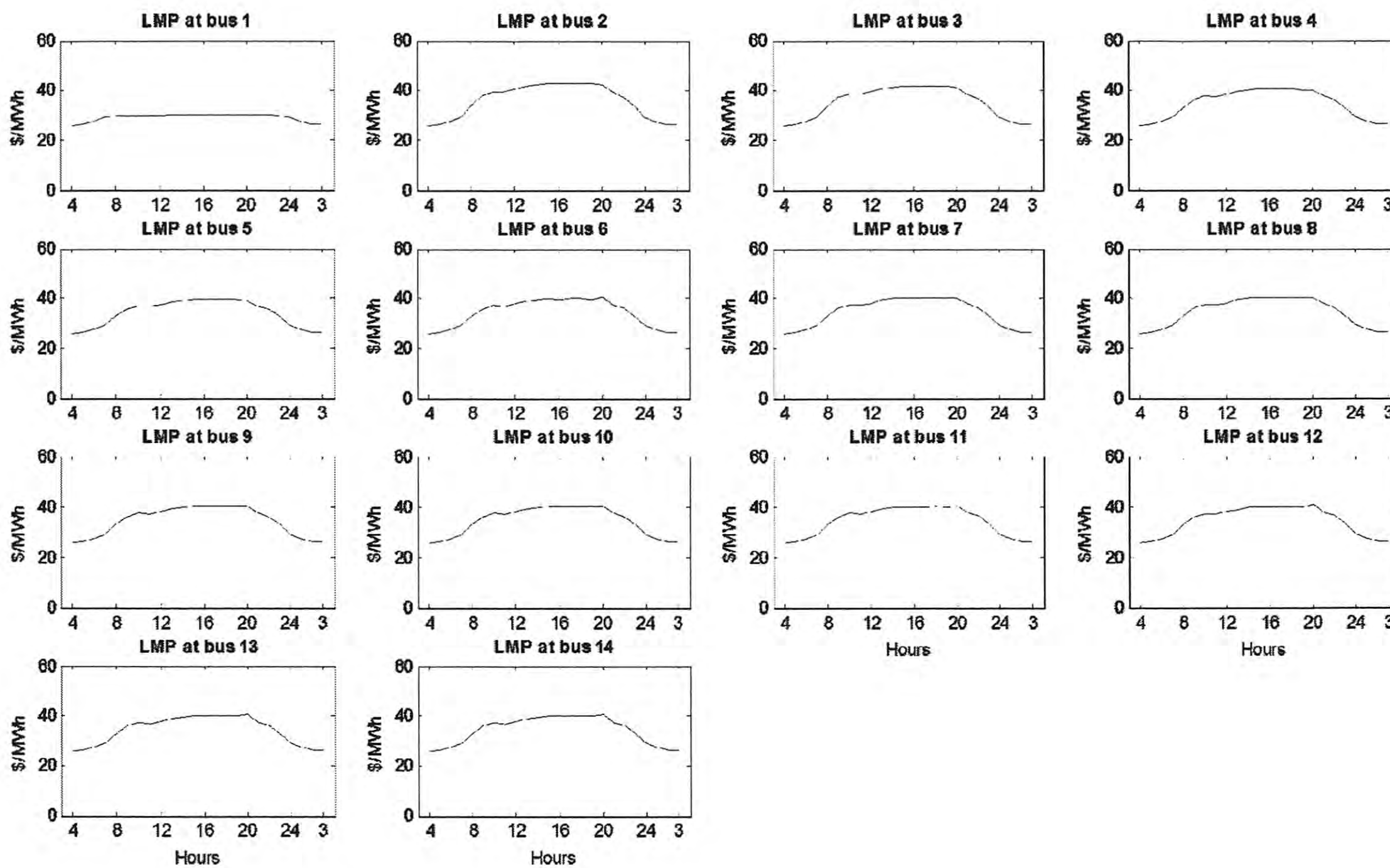
Electric power generation at each bus is shown in Figure 4.18. Like in Figure 4.15, the generator in bus 1 which has the cheapest initial generation cost produces the most amount of electricity. Generators on bus 3 and bus 4 produce electricity during business hours, from 8 a.m. to 8 p.m. Especially, generator on bus 5 which have the most expensive initial generation cost is operated for peak hour demand.



**Figure 4.18 Power Generation in G2V of Large Network**

LMP has a similar pattern, high during business hours and low during a night, and LMP at bus 1 is the lowest among LMPs on all buses. Comparing to LMP in V2G, LMP in G2V shows a little higher price, which results from the additional electric power demand from G2V service of PEV parking building.





**Figure 4.19 LMP in G2V of Large Network**

From the results for impact of V2G and G2V, it is confirmed that PEV parking building has an effect on generation, load, and LMP. Figure 4.14 and Figure 4.17 shows electricity, extracted from PEVs or used to charge PEVs, directly affects electricity power load on the bus where PEV parking building is located. On the other hands, power generation and LMP are influenced by the load changed by V2G and G2V operations. Especially, generator on bus 5 was not operated in V2G, but produces electricity in G2V due to more electric power demand increased by G2V service.

#### **4.4 Summary**

This chapter presented a model to account for the impact of a PEV parking building on a power system and the total revenue of a developer. A PEV parking building represents an interface station point between a transportation network and an electric power network. Hence, a developer's decision on location and incentive affects the traffic flow on the transportation network and the electric power flow on the electric power network.

In this chapter, optimal traffic flow was evaluated by the user equilibrium problem, which reveals PEV parking demand. Also, optimal power flow was evaluated by the optimal power flow problem. The results of the numerical example in this chapter verify the impact of a PEV parking building on power system operating conditions and locational marginal prices. The optimal location and incentive of a PEV parking building was evaluated using the total revenue

model. The results of total revenue show that the business model of V2G with LMP results in the most benefit for a developer.

## 5. CHARGING STATION INSTALLATION PROBLEM (TWO-STAGE STOCHASTIC PROBLEM WITH SIMPLE RECOURSE)

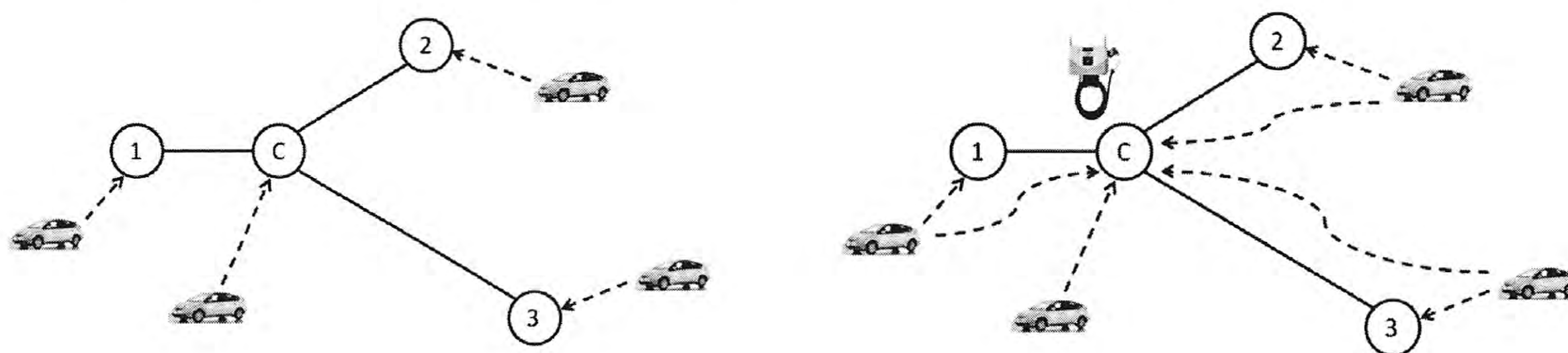
Limited capacity of PEV batteries is one of the key barriers to more widespread adoption of PEVs. It is expected that due to range anxiety, drivers with a long-distance commute will hesitate to replace their ICEV with a PEV. In this situation, a parking building with charging stations could encourage people to replace their ICEVs with PEVs as they could charge the batteries while parked.

Garage operators naturally would like to know how many charging stations to be installed. This problem is not trivial as there are many uncertain parameters, such as PEV penetration rate, and the rate of willingness to charge.

Hence, a stochastic model is formulated to evaluate different installation strategies. This model can help operators make better decisions such as how many charging stations to install. In this study, a stochastic model was formulated in the form of a two-stage stochastic problem with simple recourse and was implemented in a case study for installation of charging stations on Texas A&M University campus.

### 5.1 Problem Description

Installation of charging stations could affect drivers' parking choices. Figure 5.1 shows the influence of installation of charging stations in only one parking building. More specifically, Figure 5.1(a) illustrates drivers' behavior without charging stations. In the situation without charging stations, drivers park their vehicles in the parking garage closest to their final destinations. However, if the charging stations are not available in their closest garage (e.g. available only in garage C), a portion of PEV drivers who used to park their vehicles at the other parking buildings will change their parking preference, as shown in Figure 5.1(b).



(a) Non-installation of charging stations

(b) Installation of charging stations

**Figure 5.1. Influence of Installation of Charging Stations**

PEV parking demand in parking building C with charging stations can be calculated as the sum of the original parking demand in parking building C, and the attracted demand from other parking buildings. In order to calculate PEV demand from the other parking buildings, the total parking demand, parking users' willingness to walk, and the parameter uncertainties need to be considered. In this study, the rate of willingness to charge and the PEV penetration rate were considered to be uncertain.

The objective of this problem is to determine the optimal number of charging stations to be installed. Figure 5.2 shows the model framework. The objective of the facility operator is to minimize the sum of the installation cost and the utility cost. Here, the installation cost depends on the number of installed charging stations, while the utility cost represents a measure of utility (i.e., happiness) with the differences between the supply of charging stations and the PEV charging demand. As mentioned before, PEV parking demand is calculated based on the demand for the parking building, users' willingness to walk, and the two PEV uncertain parameters, namely PEV penetration rate and the rate of willingness to charge.

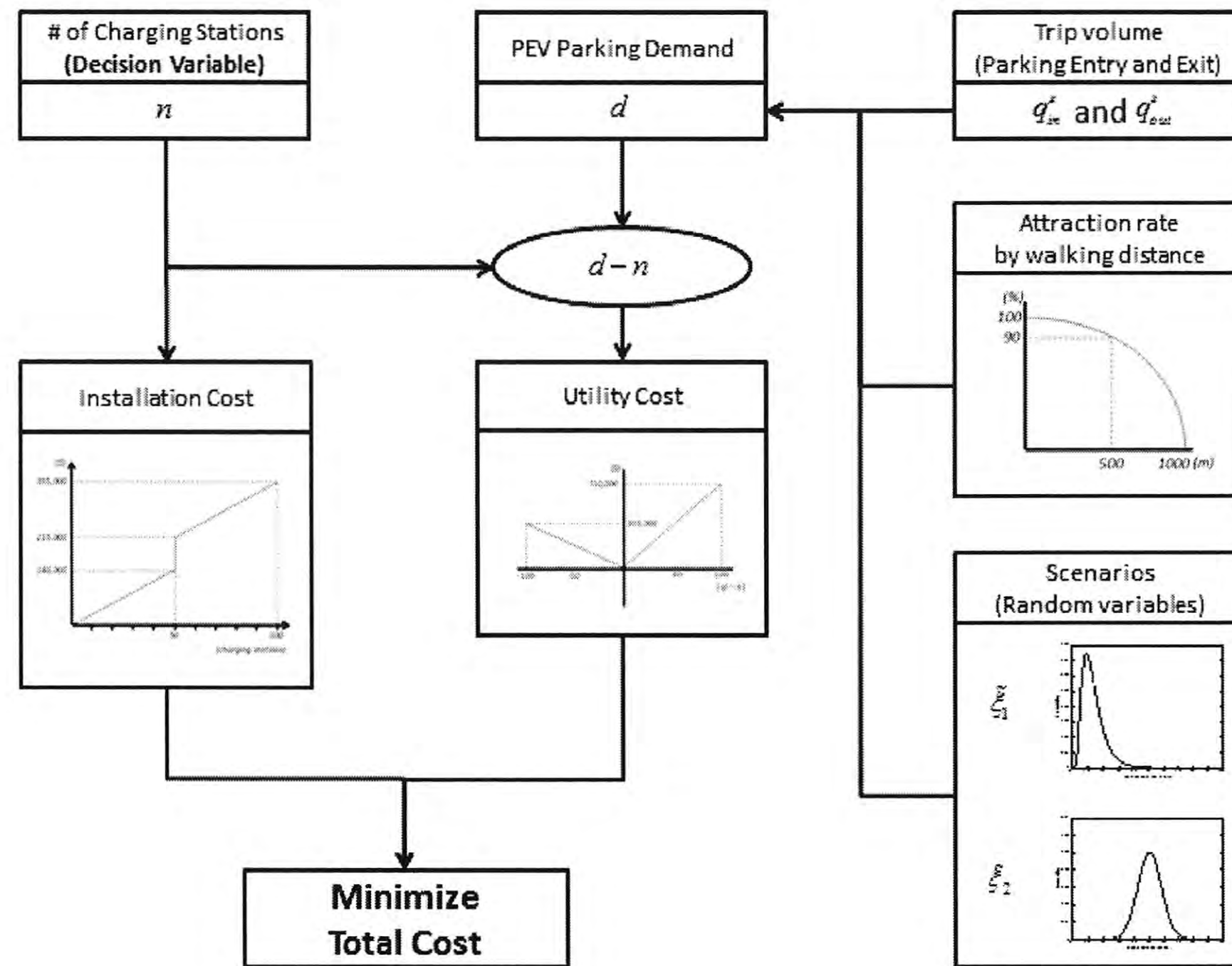


Figure 5.2. Model Framework

## 5.2 The Model

The model developed in this section is a two-stage stochastic problem with simple recourse; the first stage allocates the spaces for the charging stations, and the second stage assesses operator's utility. The objective of this problem is to minimize the sum of the installation cost and the utility cost, as shown in Equation 5.1. The constraints associated with the first stage are the space capacity for charging stations in Equation 5.2. The notations of parameters, variables, and sets used in the model are as follows:

### Sets

$$N_p = \text{the set of parking nodes}$$

### Parameters

$$N = \text{the maximum number of charging stations to be installed}$$

$$(q_{in}^s)_h = \text{the trip rate to node } S \text{ on time } h$$

$$(q_{out}^s)_h = \text{the trip rate from node } S \text{ on time } h$$

### Variables

$$d = \text{average PEV demand of parking garage}$$

$$d_h = \text{PEV demand of parking garage on time } h$$

$$f(\cdot) = \text{the installation cost}$$

$$l^s = \text{the minimum distance from node } S \text{ to the parking garage}$$

$$n = \text{the number of charging stations}$$

$$Q_j(\cdot) = \text{the developer's utility cost}$$

$$W(\cdot) = \text{the attraction rate by walking distance}$$

$(x_c)_h$  = the sum of trip rates of PEVs entering the parking garage

$(x_d)_h$  = the sum of trip rates of PEVs exiting the parking garage

### Random Variables

$\tilde{\xi}_1$  = PEV penetration rate

$\tilde{\xi}_2$  = PEV charging rate

$\xi_1^\omega$  = realization of  $\tilde{\xi}_1$

$\xi_2^\omega$  = realization of  $\tilde{\xi}_2$

$P^{\omega_1}$  =  $P(\tilde{\xi}_1 = \xi_1^\omega)$

$P^{\omega_2}$  =  $P(\tilde{\xi}_2 = \xi_2^\omega)$

The charging station installation (CSI) problem is formulated as follows:

$$\min f(n) + E[Q(d-n)] \quad (5.1)$$

$$\text{s.t. } 0 \leq n \leq N \text{ and integer} \quad (5.2)$$

$$\text{where } E[Q(d-n)] = \sum_{\omega_1 \in \Omega_1} \sum_{\omega_2 \in \Omega_2} P^{\omega_1} \cdot P^{\omega_2} \cdot Q(d-n) \quad (5.3)$$

$$d = \frac{1}{24} \sum_{h=1}^{24} d_h \quad (5.4)$$

$$d_1 = (x_c)_1 - (x_d)_1 \quad (5.5)$$

$$d_h = d_{h-1} + (x_c)_h - (x_d)_h \quad h = 2, \dots, 24 \quad (5.6)$$

$$(x_c)_h = \sum_{s \in N_p} (q_{in}^s)_h \cdot \tilde{\xi}_1 \cdot \tilde{\xi}_2 \cdot W(l^s) \quad h = 1, \dots, 24 \quad (5.7)$$

$$(x_d)_h = \sum_{s \in N_p} (q_{out}^s)_h \cdot \tilde{\xi}_1 \cdot \tilde{\xi}_2 \cdot W(l^s) \quad h = 1, \dots, 24 \quad (5.8)$$

$Q_j(d-n)$  represents the utility cost if  $n$  charging stations were installed when actual PEV parking demand was  $d$ . The motivation for this formulation is to account for the opportunity cost. The PEV parking demand is defined as the average of hourly PEV demands during one day, as shown in Equation 5.4.

Random variables of  $\tilde{\xi}_1$  and  $\tilde{\xi}_2$  represent uncertainty in parameters.  $\tilde{\xi}_1$  represents the future PEV penetration rate, and  $\tilde{\xi}_2$  represents the rate of willingness to charge. The sum of the PEV trip rates entering and exiting the parking garage,  $(x_c)_h$  and  $(x_d)_h$ , are derived from the original trip rates, random variables, and attraction rate function. This model is also referred to as the charging station installation problem.

### **5.3 Monte Carlo Bounding Approach**

The stochastic programming problem with continuous distributions is usually impossible to solve exactly, so the approximation approach can be used to solve the problem. Mak et al. (1999) proposed the Monte Carlo bounding method to solve the stochastic problem with continuous distributions. Basically, the Monte Carlo bounding technique gives confidence intervals that account for the difference between optimal and candidate solutions. The CSI problem presented in this chapter is solved based on the Monte Carlo bounding method. Abstract equations for the Monte Carlo bounding method are listed in Table 5.1. Details on this method can be found in Mak et al. (1999).

**Table 5.1 Equations for Monte Carlo Bounding Method**

	Upper Bounds	Lower Bounds
Bound Value	$\bar{U}(n_u) = \frac{1}{n_u} \sum_{i=1}^{n_u} f(\hat{n}, \tilde{\xi}^i)$	$\bar{L}(n_l) = \frac{1}{n_l} \sum_{i=1}^{n_l} \min_{n_i \in X} \left[ cn_i + \frac{1}{m} \sum_{j=1}^m f(n_i, \tilde{\xi}^{ij}) \right]$
Bound Error	$\tilde{\epsilon}_u = \frac{t_{n_u-1, \alpha} s_u(n_u)}{\sqrt{n_u}}$	$\tilde{\epsilon}_l = \frac{t_{n_l-1, \alpha} s_l(n_l)}{\sqrt{n_l}}$

Note: where  $\hat{n}$  is a candidate solution of optimal number of charging stations;  $\tilde{\xi}^i$  is independent and identically distributed from the distribution of  $\tilde{\xi}$ ;  $n_u$  and  $n_l$  are the sample sizes;  $s_u(\cdot)$  and  $s_l(\cdot)$  are the standard sample variance estimator of  $\sigma_u$  and  $\sigma_l$ ; and  $m$  is the batch size.

Based on the bound values and errors in Table 5.1, the confidence interval for the optimality gap at  $\hat{n}$  is calculated using the following equation:

$$\left[ 0, \bar{U}(n_u) - \bar{L}(n_l) + \tilde{\epsilon}_u + \tilde{\epsilon}_l \right] \quad (5.9)$$

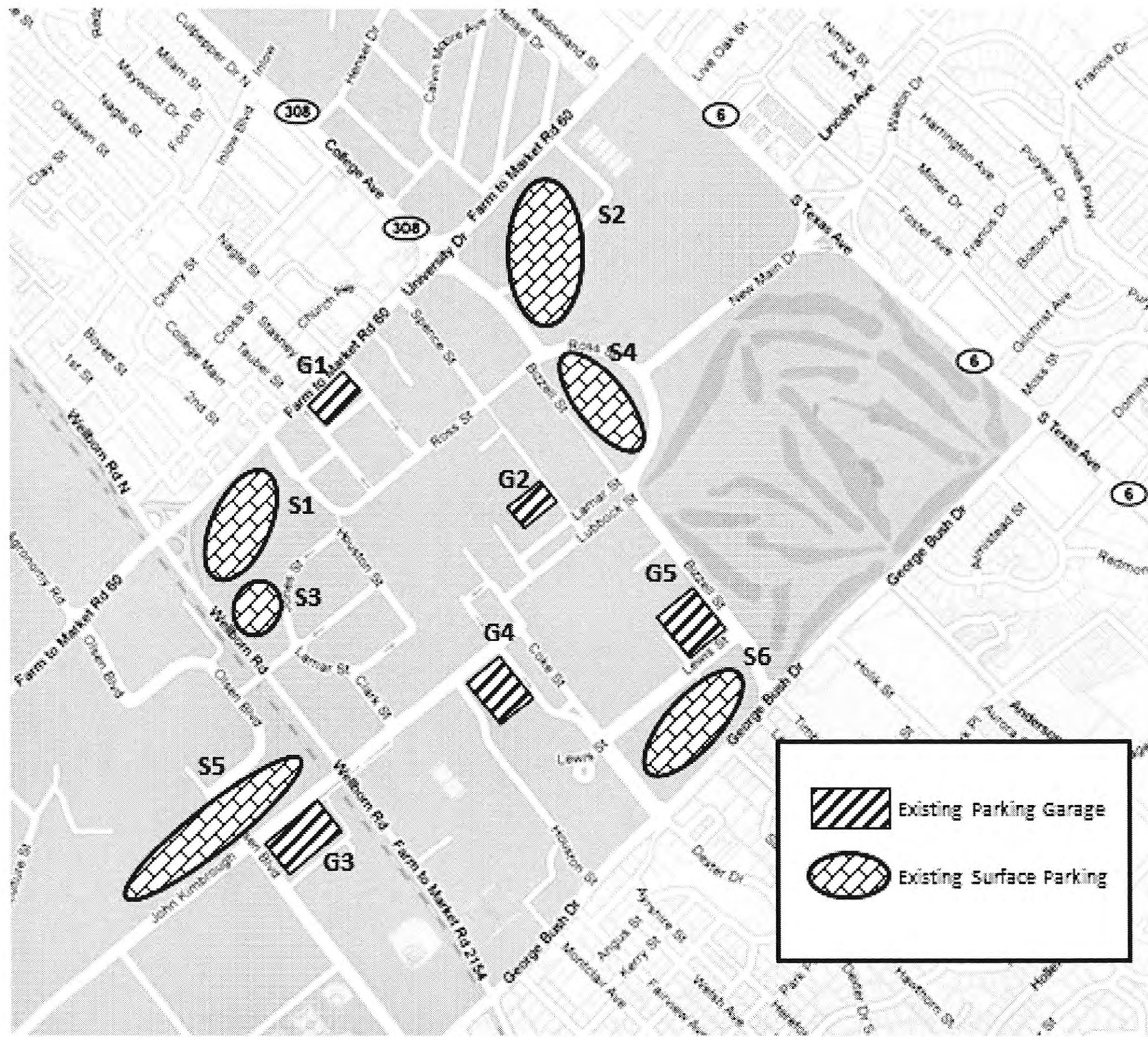
#### 5.4 Case Study

In order to demonstrate the CSI problem, the CSI project of Texas A&M University was considered for the case study. For this case study, data of parking entry and exit, parking capacity of parking buildings and lots, and location of parking buildings and lots were collected and measured. Data that were difficult to measure were assumed to be as realistic as possible.

##### 5.4.1 Area Scope

There are a number of parking buildings and open parking lots on the Texas A&M University campus in College Station, Texas. This case study considered only five parking garages and six surface parking lots, as shown in Figure 5.3.





**Figure 5.3. Existing Parking Garages and Surface Parking Lots**

The capacity of parking spaces for each parking garage and open space lot is shown in Table 5.2.

**Table 5.2 Parking Spaces**

<b>Parking ID</b>	<b>Spaces</b>	<b>Parking ID</b>	<b>Spaces</b>
S1	775	G1	2,000
S2	2,300	G2	510
S3	370	G3	3,100
S4	640	G4	1,630
S5	2,350	G5	2,250
S6	1,180		

This case study considered the Northgate garage, which shown as G1 in Figure 5.3, as the parking building where charging stations will be installed. PEV drivers who used to park in the other parking buildings or lots would have a choice of switching to the Northgate garage to charge their PEVs. Therefore, in this case study, walking distance could play an important role in deciding whether PEV drivers would use. The walking distances from the Northgate garage to the other parking buildings and open space lots are shown in Table 5.3.

**Table 5.3 Walking Distances from Northgate Garage**

<b>Parking ID</b>	<b>Walking Distance from G1 (km)</b>	<b>Parking ID</b>	<b>Walking Distance from G1(km)</b>
S1	0.5	G1	0
S2	0.75	G2	0.6
S3	0.65	G3	1.3
S4	0.65	G4	0.9
S5	1.5	G5	1.1
S6	1.3		

Using these data, the CSI problem was formulated and solved. The CSI problem sought to answer questions such as the following: What is the optimal number of charging stations to be installed in the Northgate garage?

## 5.4.2 Data

### 5.4.2.1 Installation Cost

Installation cost ( $f(n)$ ) was determined based on the number of charging stations to be installed. The installation cost is a piece-wise linear function of the number of charging stations (Figure 5.4). When 50 charging stations are installed, extra installation costs are added due to the need for a new transformer. The unit installation cost of a charging station was assumed to be \$2,000, and the cost of charging station switchgear (CSS) was assumed to be \$10,000. The CSS is actually installed when 10 charging stations are installed, but, for simplicity, the cost of CSS was assumed as linear.

$$f(n):$$

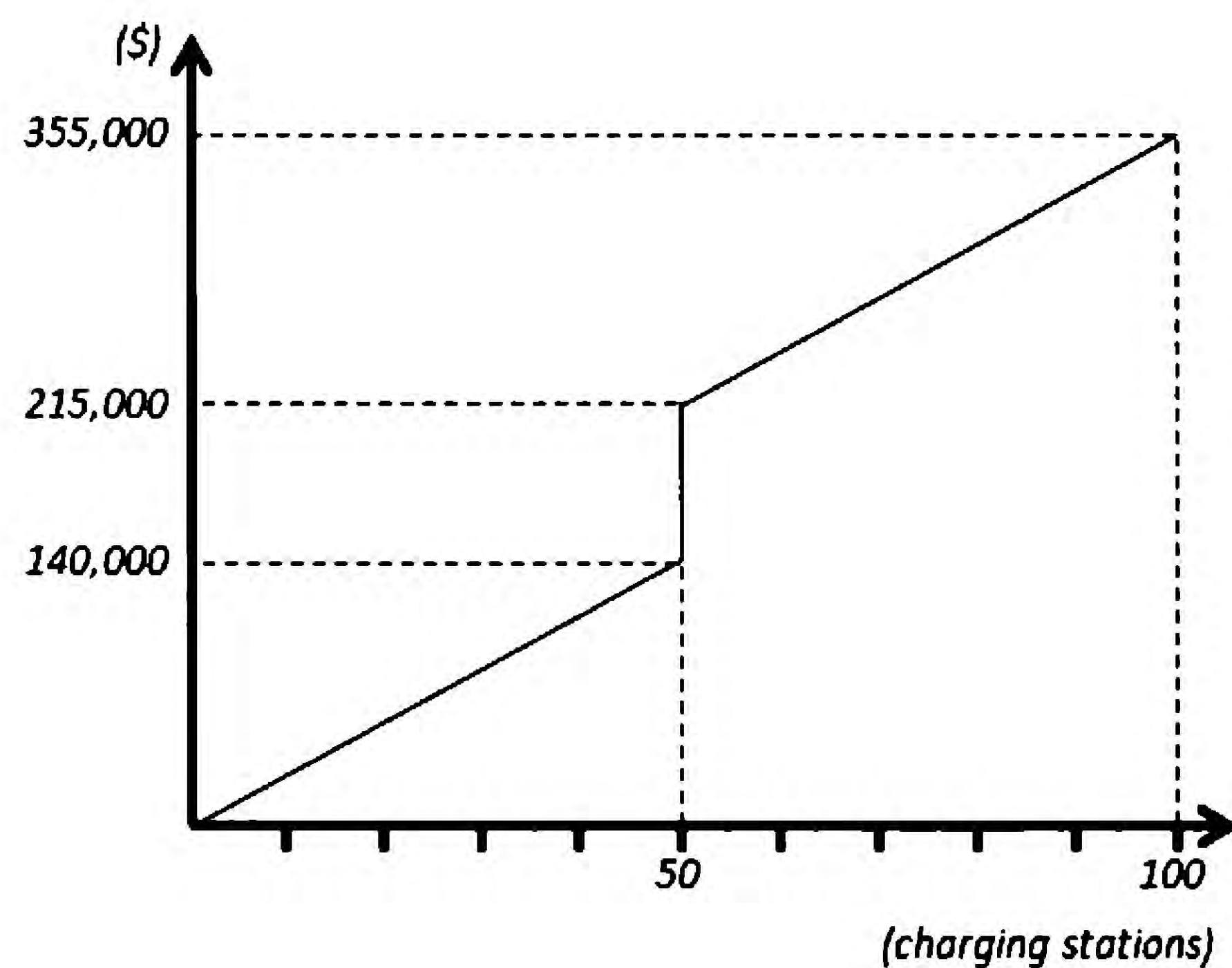
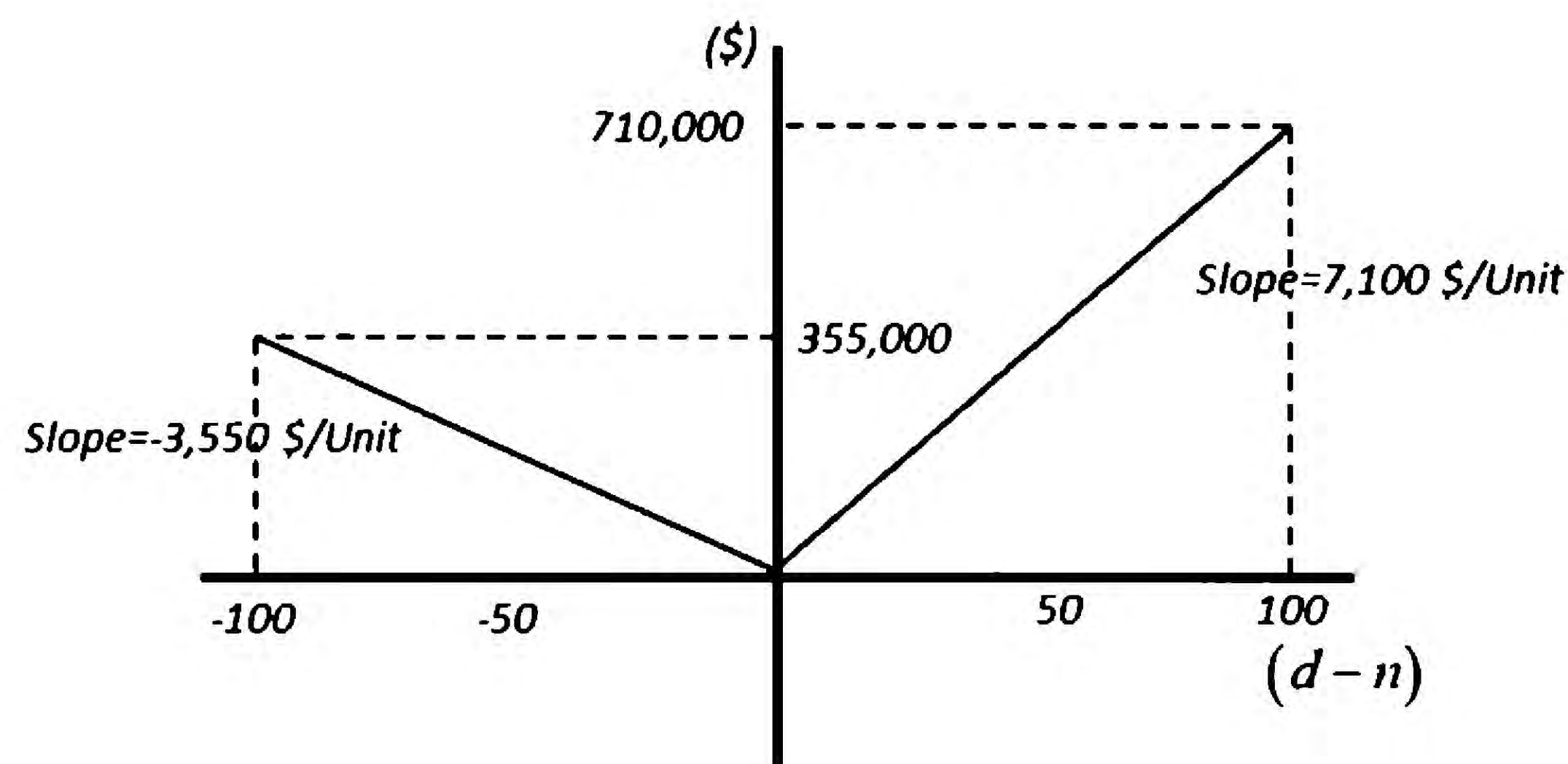


Figure 5.4. Installation Cost

### 5.4.2.2 Utility Cost

The utility cost ( $Q_j(d-n)$ ) represents the cost associated with either over-estimated or under-estimated demand. A positive value based on the difference ( $d-n$ ) means insufficient charging stations, so the operator will have additional costs derived from the loss of potential profit. On the other hand, a negative value based on the difference ( $d-n$ ) means excessive charging stations are installed, so the manager will incur the costs associated with the improper use of spaces and capital. For this case study, utility cost was defined as shown in Figure 5.5.

$$Q(d-n):$$

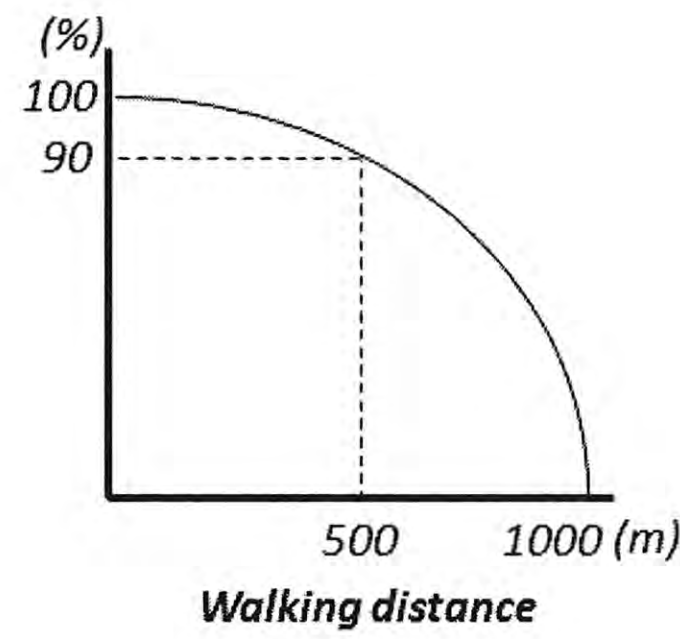


**Figure 5.5. Utility Cost**

The utility cost in Figure 5.5 shows the assumed cost that the parking facility operator may have due to over-estimated or under-estimated demand. For example, 100 excessive charging stations means the operator has installed 100 charging stations. Therefore, the utility cost of the excessive 100 charging stations is defined as \$355,000, which equals the amount of the installation cost of the 100 stations. From the perspective of the parking operator, the utility cost derived from the loss of potential profit could be higher than the utility cost from improper use of spaces. Therefore, in this case study, the utility cost of 100 insufficient charging stations is defined as twice as much as that of 100 excessive charging stations. However, these can be specified based on the operator preferences to capture the cost associated with either under-estimated demand (PEV drivers want to charge, but there are no charging stations) or over-estimated demand (manager spends money on the charging station installation, but there is no demand). Note that the values of the parameters in utility functions can be changed to reflect future preferences.

#### 5.4.2.3 Attraction Rate by Walking Distance

For this case study, the attraction rate ( $W(\cdot)$ ) was determined based on walking distance from the Northgate garage to the other parking buildings or lots. Figure 5.6 shows the attraction rate for this case study. For example, when walking distance was over 1,000 m, no PEV drivers wanted to change their parking spaces. However, 90% of the PEV drivers within 500 m wanted to park their cars at the Northgate garage. This rate can be specified based on the results of a customized survey.

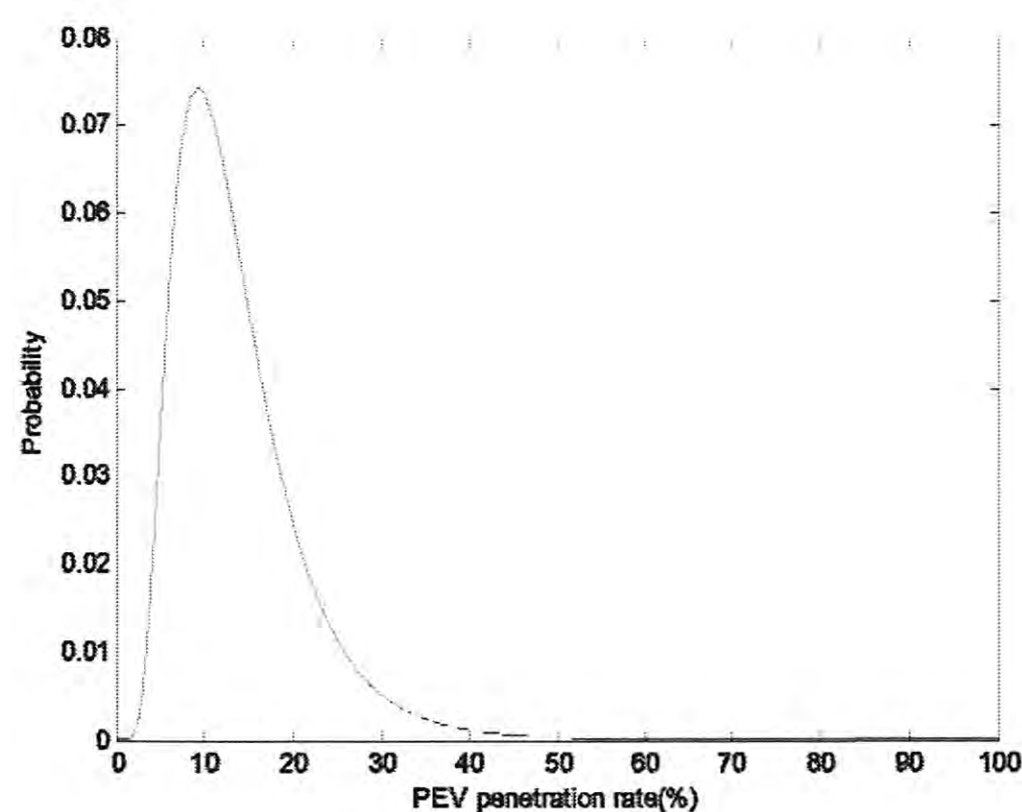


**Figure 5.6. Attraction Rate by Walking Distance**

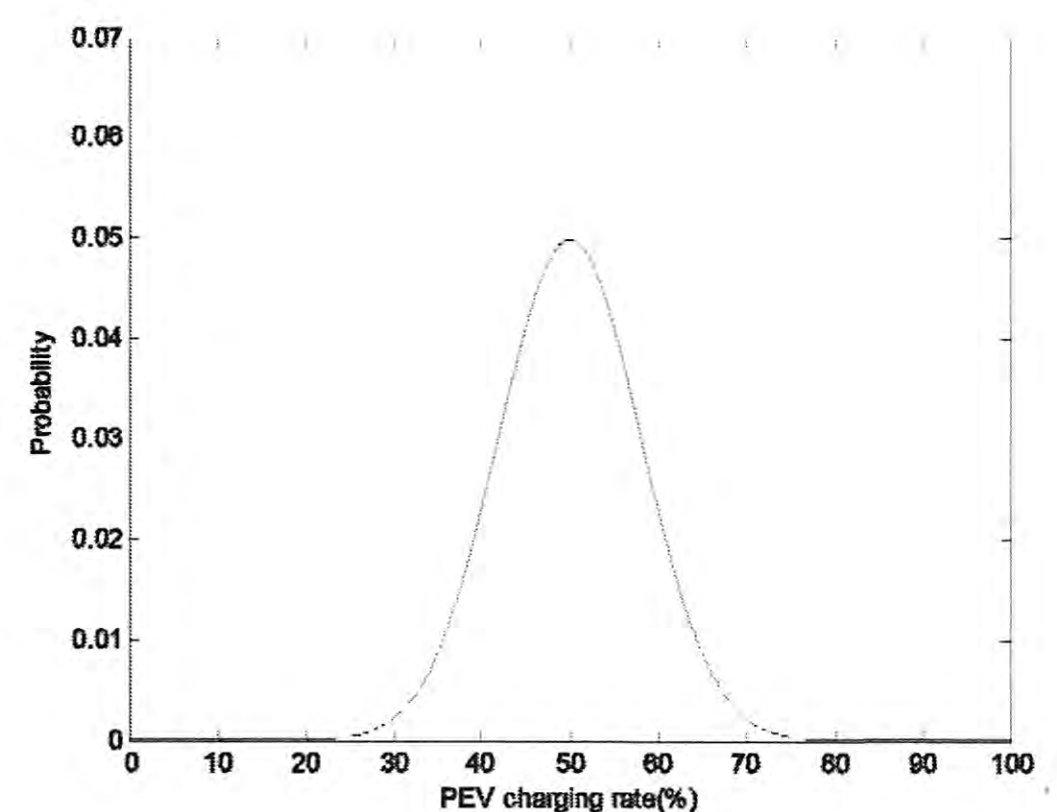
#### 5.4.2.4 Uncertainties

The CSI problem includes two uncertain parameters: PEV penetration rate and rate of willingness to charge. For this case study, the two uncertain parameters were assumed as log-normal distribution and truncated normal distribution, respectively, as shown in Figure 5.7.

PEV penetration rates were derived from log-normal distribution ( $\mu=2.5$  and  $\sigma=0.5$ ), as in Figure 5.7(a). The log-normal distribution showed the mean value of the PEV penetration rate as 13.8%. This mean value was assumed based on the forecasted results for other studies (Balducci 2008; Hadley and Tsvetkova 2008; Sullivan et al. 2009). The PEV penetration rate was assumed to not exceed 50%. The rate of charging willingness was defined in the form of truncated normal distribution ( $\mu=50$  and  $\sigma=8$ ), as shown in Figure 5.7(b). The mean value of the distribution was defined as 50%. PEV charging rate will be in the range of 20% to 80%.



(a) Log-normal distribution for PEV penetration rate



(b) Truncated normal distribution for rate of willingness to charge

**Figure 5.7. Distributions for Uncertain Parameters**

### 5.4.3 Results

The Monte Carlo bounding-based algorithm was used for determining the solution to the CSI problem in this case study. The basic information of the algorithm, such as the batch size, the number of batches, and the sample size, is presented in Table 5.4.

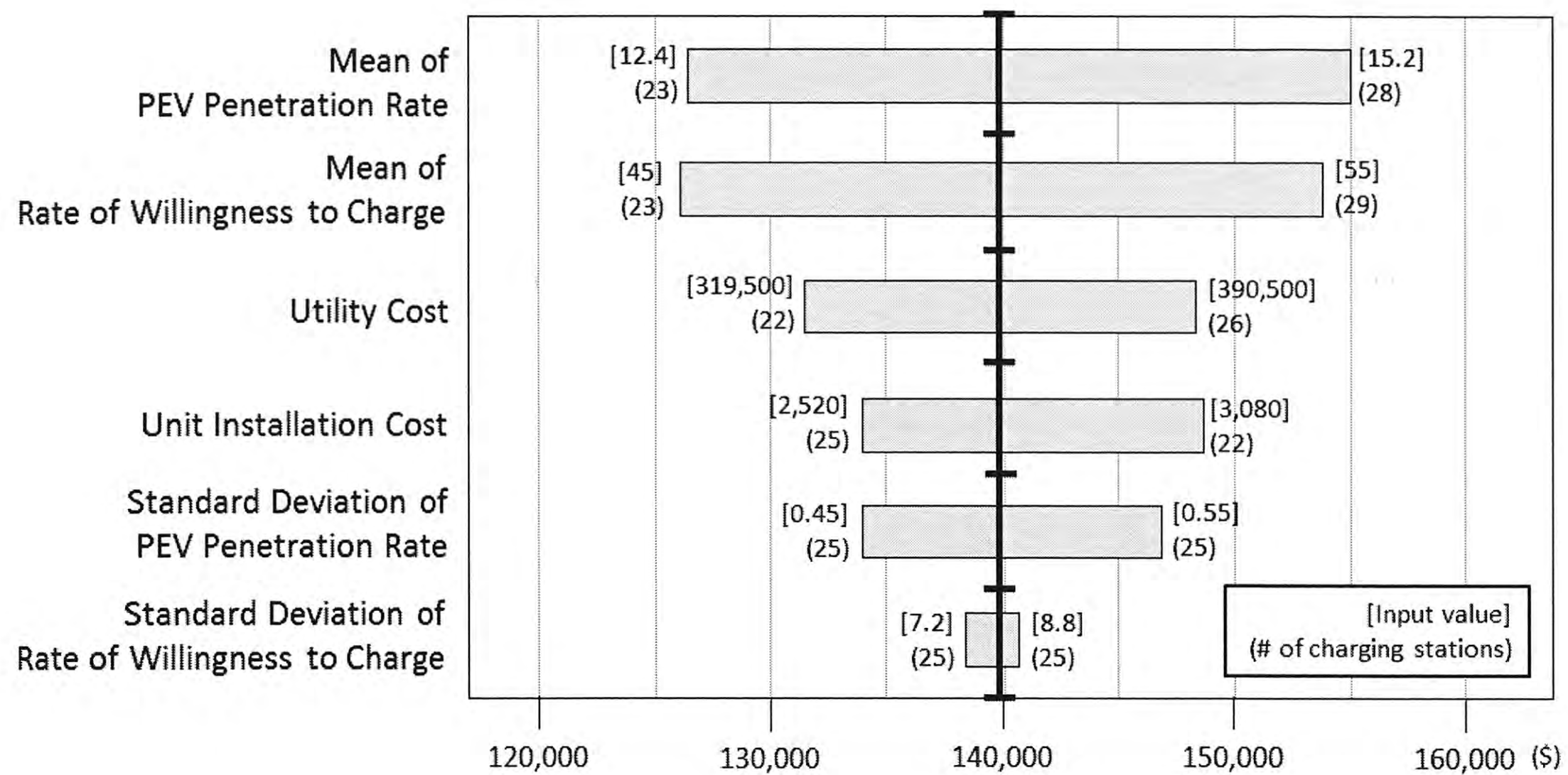
Table 5.4 also shows the computational results of the CSI problem for the Northgate garage. The analysis results, given the assumed parameters, indicated that the optimal number of charging stations was approximately 25. The upper and lower bounds were \$139,930 with \$2,033 ( $\alpha = 0.95$ ) and \$139,550 with \$2,752 ( $\alpha = 0.95$ ).

**Table 5.4 Results**

<b>Optimal Solution (<math>n^*</math>)</b>	25
<b>Lower Bound</b>	
Batch size	30
Number of batches	30
Point estimate	139,550
Error estimate	2,752
<b>Upper Bound</b>	
Sample size	1,000
Point estimate	139,930
Error estimate	2,033
<b>CPU Time (sec.)</b>	239

### 5.4.4 Sensitivity Analysis

As the value of parameters in the model was uncertain, a sensitivity analysis was conducted to understand the extent of the marginal influence. Figure 5.8 shows the results from the sensitivity analysis. In Figure 5.8, a tornado diagram shows the effect of the parameters on the total cost and the number of charging stations. The bar at the top of the diagram indicates the most significant effect on the total cost. The bold line in the middle of the bars indicates the results based on the parameters defined in previous sections. The values at the end of the bars indicate the input values and the number of charging stations.



**Figure 5.8. Results of Sensitivity Analysis**

For example, the value for the mean of the PEV penetration rate was initially assumed to be 13.8%. For the sensitivity analysis, the PEV penetration rate was modified to 12.4% and 15.2% as the values at the end of a bar. The result using the 12.4% PEV penetration rate showed a decrease in the total cost to around \$127,000, and the optimal number of charging stations decreased to 23. On the other hand, the result using 15.2% showed an increase in the total cost to around \$155,000, and the optimal number of charging stations increased to 28.

Additional findings from the study are as follows:

- The mean of the PEV penetration rate and rate of willingness to charge showed the most significant effect on total cost and the number of charging stations, respectively.
- The utility cost and the mean of the rate of willingness to charge showed a significant effect on both total cost and the number of charging stations.
- The unit installation cost showed a moderate effect on both the total cost and the number of charging stations.
- Standard deviation (SD) of the PEV penetration rate showed a moderate effect on total cost but no effect on the number of charging stations.
- The SD of the rate of willingness to charge showed a slight effect on both total cost and the number of charging stations.

Some managerial implications can be suggested based on the results of the sensitivity analysis. First, the parking facility operator should focus more on forecasting the mean values of the two random variables (PEV penetration rate and rate of willingness to charge) at the planning stage. These are critical values in determining the total cost and the number of charging stations. Second, in order to reduce the total cost, it is recommended that managers reduce the utility cost

and unit installation cost. Unlike the uncertain rates, these two costs may be manipulated by the parking operator based on policies to encourage the use of PEVs.

### ***5.5 Summary***

This chapter presented a model to determine the optimal number of charging stations to be installed in a single parking building, which was applied to the Northgate garage project on the Texas A&M University campus in College Station. The model calculated the PEV parking demand at the Northgate garage and considered uncertainty in parameters, such as the PEV penetration rate and rate of willingness to charge, as well as the attraction rate. The Monte Carlo bounding-based algorithm was used to solve this CSI problem. The analysis result showed the optimal number of charging stations and the upper and the lower bounds of the total cost. Sensitivity analysis suggested that the facility manager should be careful in determining utility cost.



## **6. CHARGING STATION INSTALLATION PROBLEM WITH DECISION-DEPENDENT ASSESSMENT OF UNCERTAINTY (TWO-STAGE STOCHASTIC PROBLEM WITH RECOURSE)**

The CSI problem in Chapter 5 identified the number of charging stations that minimizes the total cost. The CSI problem had only one decision variable: the number of charging stations to be installed in the first stage. In addition, the CSI problem in Chapter 5 did not consider that the decision in the first stage has an effect on realization of uncertain parameters.

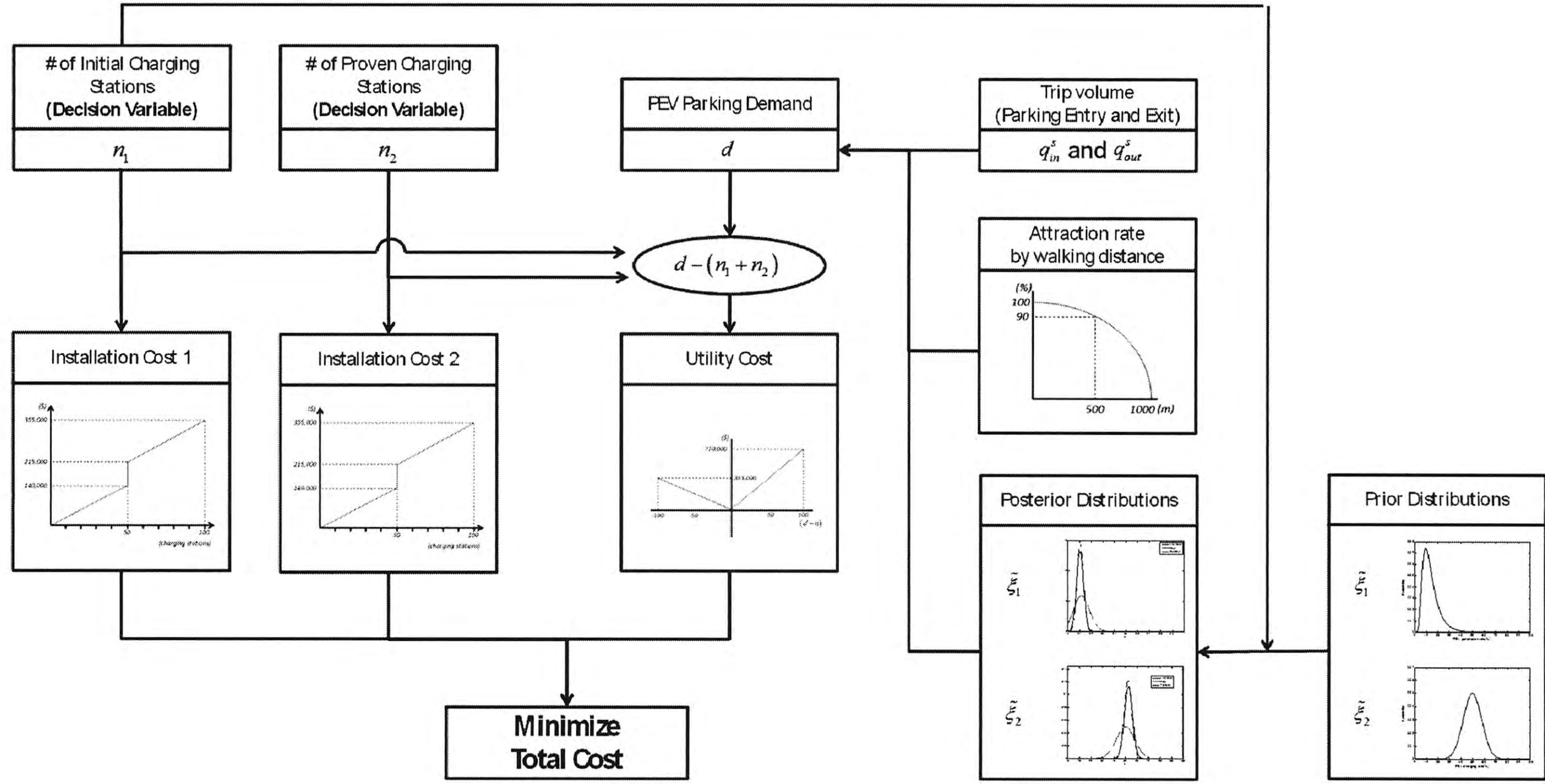
This chapter presents a charging station installation problem with decision-dependent assessment of uncertainty (CSI-DDAU problem). The problem has two decision variables—decisions at first and second stages—and includes the impact of the first decision on uncertainties. The next section will present an overview of the problem and model framework. Section 6.2 presents the charging station installation problem with decision-dependent assessment of uncertainty. In Section 6.3, the decision-dependent assessment of uncertainty is explained in detail. The case study for the CSI-DDAU problem is provided in Section 6.4.

### ***6.1 Problem Description***

The influence of the installing charging stations at specific garage location on parking choices, described in the previous chapter, is considered in this chapter as well. That is, the installation of charging stations can change PEV drivers' parking choices. The difference between the CSI-DDAU problem and the CSI problem from the previous chapter is that the parking operator makes two decisions in the CSI-DDAU problem. The first decision is made in the first stage with primary uncertainties, the second decision is made in the second stage with updated uncertainties. After making the first decision, operators have time to observe the change in the PEV penetration rate and rate of willingness to charge, and they make a second stage decision with more information about uncertain parameters.

The objective of this problem is to determine the optimal number of charging stations, like in the CSI problem. Figure 6.1 shows the model framework. Compared to the model framework for the CSI problem, the CSI-DDAU problem uses a Bayesian updating process. While the first decision, the number of initially installed charging stations affects installation cost 1, utility cost, and Bayesian updating of the distribution of uncertain parameters, the second decision, the number of additional charging stations, affects only installation cost 2 and utility cost.

Figure 6.1 Model Framework



## 6.2 The Model

The two-stage recourse model has two decision variables: the number of initial charging stations ( $n_1$ ) to be installed at the first stage, and the number of charging stations ( $n_2$ ) at the second stage. At first stage, manager installs initial charging stations, and observes the changes of PEV penetration rate and the rate of willingness to charge. At second stage, operator installs additional charging stations based on the observed changes in two uncertain parameters.

Two decisions,  $n_1$  and  $n_2$ , are made in order to minimize the sum of the two installation costs and the utility cost. The constraints associated with the first and second stage represent the space capacity for the charging stations, as shown in Equation 6.2 and 6.4, respectively. Equations 6.5 through 6.9 are defined to calculate PEV parking demand. The notations of parameters, variables, and sets used in the model can be found in Section 5.2.

$$\min f_1(n_1) + E\left[Q(n_2, \tilde{\xi})\right] \quad (6.1)$$

$$\text{s.t.} \quad 0 \leq n_1 \leq N \text{ and integer} \quad (6.2)$$

$$\text{where} \quad E\left[Q(n_2, \tilde{\xi})\right] = \min f_2(n_2) + \sum_{\omega_1 \in \Omega_1} \sum_{\omega_2 \in \Omega_2} P^{\omega_1} \cdot P^{\omega_2} \cdot Q(d - (n_1 + n_2)) \quad (6.3)$$

$$\text{s.t.} \quad 0 \leq n_1 + n_2 \leq N, n_2 \text{ integer} \quad (6.4)$$

$$\text{where} \quad d = \frac{1}{24} \sum_{h=1}^{24} d_h \quad (6.5)$$

$$d_1 = (x_c)_1 - (x_d)_1 \quad (6.6)$$

$$d_h = d_{h-1} + (x_c)_h - (x_d)_h \quad (6.7)$$

$$h = 2, \dots, 24$$

$$(x_c)_h = \sum_{s \in N_p} (q_{in}^s)_h \cdot \tilde{\xi}_1 \cdot \tilde{\xi}_2 \cdot W(l^s) \quad (6.8)$$

$$h = 1, \dots, 24$$

$$(x_d)_h = \sum_{s \in N_p} (q_{out}^s)_h \cdot \tilde{\xi}_1 \cdot \tilde{\xi}_2 \cdot W(l^s) \quad (6.9)$$

$$h = 1, \dots, 24$$

Random variables, PEV penetration rate, and rate of willingness to charge ( $\tilde{\xi}_1$  and  $\tilde{\xi}_2$ ) are realized from updated uncertainties, which indicate the posterior distributions of uncertain parameters. The details of the uncertainty updating process are described in the next section.

### **6.3 Decision-Dependent Assessment of Uncertainty**

A manager's decision can influence the uncertainty in parameters. For example, PEV owners who have seen charging stations installed in parking buildings tend to take advantage of the charging service. This is similar to product advertisements affecting a consumer's choice. The updated uncertainty of a decision is referred to as 'decision-dependent assessment of uncertainty' in this report.

For this model, decision-dependent assessment of uncertainty is evaluated using Bayesian inference. The updated uncertainty could be obtained in the form of a probability density function and is evaluated as a posterior distribution in Bayesian inference. The posterior distribution is derived from prior and likelihood distributions.

Figure 6.2 shows the Bayesian updating process. First, in Figure 6.2(a), a PEV penetration rate is realized as the initial PEV penetration rate. Based on the initial penetration rate, PEV parking demand is calculated from the parking demand, as shown in Figure 6.2(b), and beta distribution of the PEV penetration rate is updated, as in Figure 6.2(c).

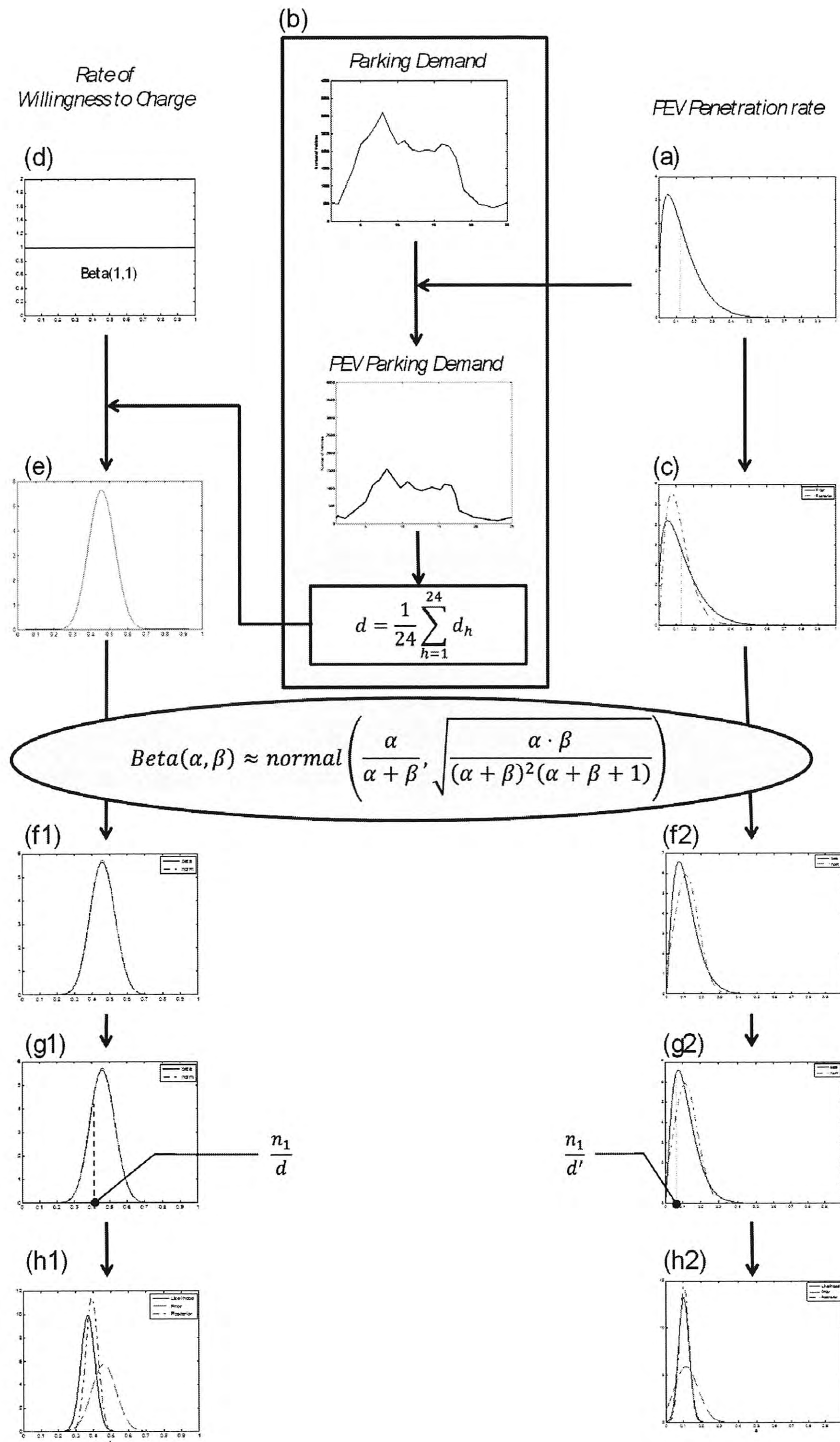
The rate of willingness to charge is also evaluated using Bayesian inference. Figure 6.2(d) shows the Bayesian updating for the rate of charging willingness. Beta distribution, derived from uniform distribution by Monte Carlo simulation, is used as a prior distribution because PEV drivers' charging preference is initially unknown. Uniform distribution is widely used as a non-informative prior. The rate of charging willingness is updated, as shown in Figure 6.2(e), through Bayesian updating.

Beta distributions of the PEV penetration rate and rate of willingness to charge can be approximated by normal distributions. The parameters of normal distribution, mean, and standard deviation can be assessed by the parameters of beta distribution, as shown in Equation 6.10. Figure 6.2(f1) and (f2) show approximated normal distributions for the PEV penetration rate and rate of willingness to charge, respectively.

$$\mathbf{Beta}(\alpha, \beta) \approx \mathbf{normal} \left( \frac{\alpha}{\alpha + \beta}, \sqrt{\frac{\alpha \cdot \beta}{(\alpha + \beta)^2 (\alpha + \beta + 1)}} \right) \quad (6.10)$$

Restriction is set based on the first decision, the number of initial charging stations, as in Figure 6.2(g1) and (g2). The restriction point of the rate of willingness to charge is set as the ratio of the number of charging stations to the PEV parking demand ( $n_1 / d$ ) because a charging demand greater than the charging capacity of a PEV parking building will result in PEV drivers disappointment; hence, the rate of charging willingness will be reduced. In the same way, the restriction point of the PEV penetration rate is set as the ratio of the number of charging stations to parking demand.

Likelihood distribution is generated based on the restricted prior distribution by the Monte Carlo sampling method. Finally, posterior distributions are obtained based on prior and likelihood distributions, as in Figure 6.2(h1) and (h2). The posterior distributions show lower variance compared to prior distributions, which indicates that uncertainty is reduced after Bayesian updating.



**Figure 6.2. Procedure of Bayesian Updating**

### 6.4 Case Study

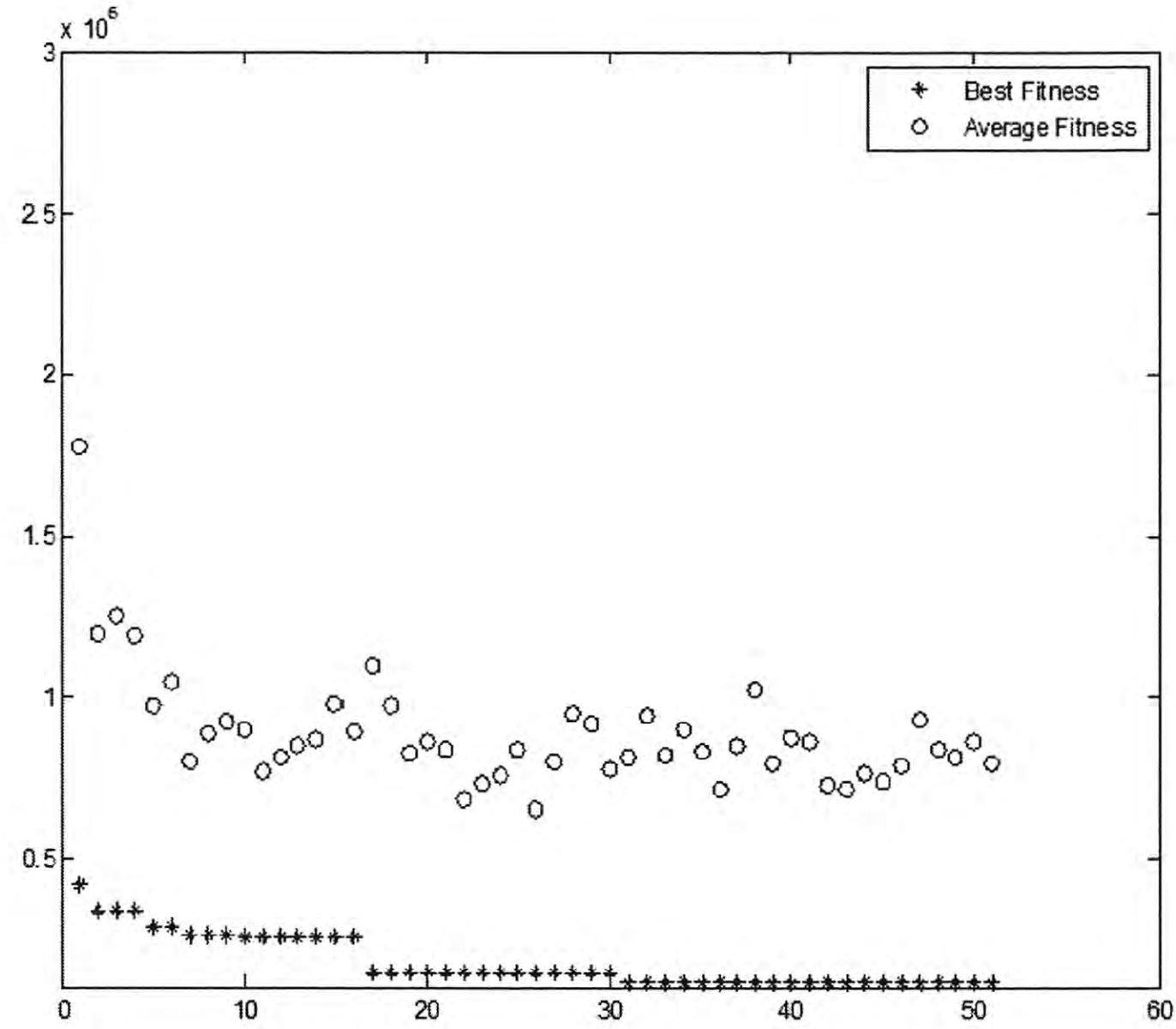
In order to demonstrate the CSI-DDAU problem, the CSI project of Texas A&M University, which was used as a case study in Chapter 5, was used again. Installation cost, utility cost, and uncertainties were assumed and defined as the same values in the case study in Chapter 5. For the CSI-DDAU problem, the installation cost function for initial charging stations ( $f_1(\cdot)$ ) was defined as being the same as for additional ones ( $f_2(\cdot)$ ).

The stochastic programming problem with continuous distributions is usually impossible to solve exactly, so the approximation approach can be used to solve the problem (Morton and Popova 2004; Mak et al. 1999). To solve the CSI-DDAU problem, two methods were used: Monte Carlo sampling to generate some observations of the random parameters and genetic algorithm to find the best combination of decision variables. Basic GA operators for the case study are defined in Table 6.1.

**Table 6.1 Methods and Parameters of GA Operators**

Operator	Method	Parameter
Selection	Binary Tournament Selection	1. Population size: 30 2. Elites: 2
Cross-Over	Simulated Binary Cross-Over	1. Rate of cross-over: 0.7 2. Distribution index ( $\eta$ ): 0.05
Mutation	Gaussian Mutation	1. Rate of mutation: 0.3 2. Standard deviation: • 20 (for first decision) • 20 (for second decision)

Figure 6.3 shows the best fitness and average fitness for all generations. At the end of generation, GA found the best fitness value, which was around \$150,000. The minimized total cost was obtained at \$155,130, and the optimal decisions were 18 charging stations at the first stage and three charging stations at the second stage.



**Figure 6.3 Fitness Graph for Total Cost**

In addition to genetic algorithm, Monte Carlo bounding and Bayesian updating methods were used for determining the solution of the CSI-DDAU problem. The basic information of the algorithm, such as the batch size, the number of batches, and the sample size, were the same as in the CSI problem.

Table 6.2 shows the computational results of the CSI-DDAU problem. The analysis results, given the random parameters, indicated that the optimal decisions for the two stages were 18 charging stations at the first stage and three charging stations at the second stage. The upper and lower bounds were \$156,460 with \$4,190 ( $\alpha = 0.95$ ) and \$155,130 with \$4,170 ( $\alpha = 0.95$ ). Compared to the results of the CSI problem, the total cost in the CSI-DDAU problem is higher than that in the CSI problem, and the number of charging stations in the CSI-DDAU problem is less than that in the CSI problem. It is expected that these differences result from uncertainty in parameters.



**Table 6.2 Results**

<b>Optimal Solution (<math>n_1^*</math> and <math>n_2^*</math>)</b>	18 and 3
<b>Lower Bound</b>	
Batch size	30
Number of batches	30
Point estimate	155,130
Error estimate	4,170
<b>Upper Bound</b>	
Sample size	1,000
Point estimate	156,460
Error estimate	4,190
<b>CPU Time (sec)</b>	3,358

### **6.5 Summary**

This chapter presented a charging station installation problem with decision-dependent assessment of uncertainty. The objective of the CSI-DDAU problem was to find the optimal number of charging stations at the first and second stages and the amount of minimum total cost. This chapter showed how the first decision affects uncertainty in parameters. The Bayesian updating process gave a posterior distribution of each parameter, which is the updated uncertainty. Based on the posterior distribution, the decision at the second stage was made to minimize the total cost.

Monte Carlo bounding, Bayesian updating, and genetic algorithm were used to solve this CSI-DDAU problem. The analysis results showed a lower number of total charging stations and higher upper and lower bounds of the total cost compared to the results of the CSI problem.



## 7. SUMMARY AND CONCLUSIONS

This chapter summarizes the work and contributions of this research and discusses limitations. Employed methodologies and recommendations for future research are also discussed. In the first section, the suggested problems and solution methods in this research are summarized, along with the contributions of this research. The second section presents the limitations of the developed methodologies and suggests some recommendations for future research.

### *7.1 Overall Summary and Discussion*

The major objective of this research was to develop a strategic model to make optimal decisions for constructing PEV parking buildings and installing charging stations and to investigate the impact of PEV parking buildings on electric power systems. More specifically, the PEV parking building development problem supports the evaluation of the optimal location of parking buildings and incentive structures to maximize a developer's profit, while the charging station installation problem aids parking building managers in deciding the optimal number of charging stations to be installed. The work done in this research is reviewed next in terms of the specific research objectives listed in Chapter 1.

1. Develop a deterministic PEV infrastructure development problem that can be used to find optimal decisions based on current traffic and power system conditions.

In order to consider the two different systems, a PEV parking building problem was proposed in the form of a bilevel programming problem. An upper-level BLPP is a managerial problem that consists of three revenue components, and a lower-level follower problem of BLPP explains drivers' behavior. The relationship between a developer's decision and drivers' behavior was formulated in a modified link cost function in Chapter 3.

2. Develop a stochastic PEV charging station installation problem that can be used to decide the optimal number of charging stations to be installed in existing parking buildings.

A stochastic programming problem was developed to consider uncertainty in parameters, such as PEV penetration rate and rate of willingness to charge. This report presented two stochastic programming problems—a two-stage simple recourse problem and a two-stage recourse problem with decision-dependent assessment of uncertainty—in Chapter 5 and Chapter 6, respectively. In contrast to conventional stochastic problems, a continuous distribution of random parameters was applied to consider more various scenarios. In particular, the CSI-DDAU problem in

Chapter 6 showed how a manager's decision affects uncertainty in parameters. The influence was modeled using the Bayesian updating process.

3. Design meta-heuristic algorithms that can exploit problem structure in solving a problem and can make it possible to find a near-optimal solution for the proposed problem within a reasonable run time.

Bilevel programming problems and stochastic programming problems with continuous distributions are very difficult to solve exactly. To find the best-quality combination solution, a genetic algorithm was applied to the PEV parking building problem, CSI problem, and CSI-DDAU problem. The Monte Carlo bounding method was applied to the CSI problem and CSI-DDAU problem to solve the stochastic programming problem with continuous distributions.

4. Develop a model to investigate the impact of PEV infrastructures on transportation networks and electric power systems.

The impact of a PEV infrastructure on the two systems was investigated in terms of locational marginal prices. A PEV parking building, in V2G and G2V modes, will influence a power system's operating condition as electric generation or load. Change of LMP was observed by integration of power flow analysis and the PEV parking building problem. The results of the numerical example in Chapter 4 verified the impact of a PEV parking building on power system operating conditions and locational marginal prices.

5. Make recommendations that would assist PEV infrastructure developers and managers in the decision stage regarding construction of a new facility or installation of charging stations in an existing facility.

Managerial implications and recommendations for PEV parking building developers and managers were suggested in terms of sensitivity analysis. Walkability and maximum trip rate showed much influence on a developer's total revenue, so these two factors should be considered when developing new PEV parking buildings. In addition, managers who have a plan to install charging stations in existing parking buildings should try to reduce the difference between the supply of charging stations and the PEV charging demand.

## ***7.2 Recommendations for Future Research***

Although this study developed beneficial models for PEV parking developers and managers, the models do not consider all possible scenarios and factors. If PEV parking buildings and charging stations are to become widespread, many additional important factors and problems that were not considered in this study need to be addressed. This section identifies some issues as recommendations for future research.

First, the PEV parking charging problem described in Chapter 3 focused on deterministic traffic flows. The problem can be extended to account for uncertainty, where the trips are considered as cross-correlated stochastic processes. Deterministic equilibrium assignment for traffic flow assumes that drivers have perfect information, which is not real. The stochastic process can relax the assumption of perfect information.

Second, in the PEV parking building problem detailed in Chapter 3, sensitivity of the demand based on the incentive parameter ( $\gamma$ ) was assumed, not estimated from surveys. A more realistic value of the incentive parameter could be obtained using surveys.

Third, other potential revenue models (e.g., charging service, carbon credit trading, and outage management service) or initial cost models (e.g., capital cost and real estate cost) could be added to the PEV parking building problem.

Fourth, in the PEV parking building problem, the model extension that considers capital and location-specific real estate costs can ultimately be used to determine an investment decision. This can be done on an ad hoc basis or if the costs show some structure with respect to network links, via cost functions.

Fifth, the CSI problem and CSI-DDAU problem in this study focused on installation of charging stations in a fixed parking building. The problems can be extended to a capacitated facility location problem and multiple facilities location problem. The future problems would make the CSI and CSI-DDAU problems more open and flexible.

Finally, utility cost of a parking building manager was identified as the most sensitive factor in the CSI and CSI-DDAU problems. Therefore, to obtain more realistic results, a more accurate utility cost function needs to be defined.



## REFERENCES

- Abdulaal, M. and Leblanc, L.J. (1979). "Continuous equilibrium network design models." *Transportation Research Part B*, 13B, 19-32.
- Axsen, J. and Kurani, K.S. (2008). *The Early U.S. Market for PHEVs: Anticipating Consumer Awareness, Recharge Potential, Design Priorities and Energy Impacts*. Institute of Transportation Studies, University of California, Davis.
- Balducci, P.J. (2008). *Plug-in Hybrid Electric Vehicle Market Penetration Scenarios*. Pacific Northwest national Laboratory.
- Beale, E.M.L. (1955). "On Minimizing a Convex Function Subject to Linear Inequalities." *Journal of Royal Statistical Society*. B17, 173-184.
- Beckmann, M., McGuire, G.B., and Winstern, C.B. (1956). *Studies in the Economics of Transportation*. Yale University Press.
- Birge, J.R. and Rosa, C.H. (1995). "Modelling investment uncertainty in the costs of global CO2 emission policy." *European Journal of Operations Research*, 83, 466–488.
- Bureau of Public Roads (1964). *Traffic Assignment Manual*. US Department of Commerce, Urban Planning Divisions, Washington, D.C.
- Carino, D.R., Kent, T., Meyers, D.H., Stacy, C., Sylvanus, M., Turner, A.L., Watanabe, K., and Ziemba, W.T. (1994). "The Russel- Yasuda Kasai Model: An asset/liability model for a Japanese insurance company using multistage stochastic programming." *Interfaces*, 24(1), 29-49.
- Cooper, L. (1963). "Location–Allocation Problems." *Operations Research*, 11, 331–343.
- Dantzig, G.B. (1955). "Linear Programming under Uncertainty." *Management Science*, 1, 197-206.
- Davis, G.A. (1994). "Exact local solution of continuous network design problem via stochastic user equilibrium assignment." *Transportation Research Part B*, 28B(1), 61-75.

- Denholm, P. and Short, W. (2006). *An Evaluation of Utility System Impacts and Benefits of Optimally Dispatched Plug-in Hybrid Electric Vehicles*. National Renewable Energy Laboratory (NREL).
- Ergün, G. (1971). "Development of a Dwortown Parking Model." *Highway Research Record*, 369, 118-134.
- Fell, K., Huber, K., Zink, B., and others. (2010). *Assessment of plug-in electric vehicle integration with ISO/RTO Systems*. Technical report, ISO/RTO Council.
- Fisk, C.S. (1984). "Game theory and transportation systems modeling." *Transportation Research Part B*, 18B(4), 301-313.
- Fox, H. and Associates (1994). *User Guide to PEDROUTE 3.15*. Halcrow Fox, London.
- Frantzeskakis, L. and Powell, W.B. (1990). "A successive linear approximation procedure for stochastic, dynamic vehicle allocation problems." *Transportation Science*, 24, 40–57.
- Friesz, T.L., Cho, H., Mehta, N.J., Tobin, R.L., and Anandalingam, G. (1992). "A simulated annealing approach to the network design problem with variational inequality constraints." *Transportation Science*, 26(1), 18-26.
- Garcia, R. and Marin, A. (2002). "Parking capacity and pricing in park'n ride trips: A continuous equilibrium network design problem." *Annals of operations research*, 116, 153-178.
- Goldman, A.J. (1971). "Optimal Center Location in Simple Networks." *Transportation Science*, 5, 212–221.
- Guille, C. and Gross, G. (2009). "A conceptual framework for the vehicle-to-grid (V2G) implementation." *Energy Policy*, 37(11), 4379-4390.
- Hadley, S.W. and Tsvetkova, A. (2008). *Potential Impact of Plug-in Hybrid Electric Vehicles on Regional Power Generation*. Oak Ridge National Laboratory.
- Hansen, P., Jaumard, B., and Savard, G. (1992). "New branch and bound rules for linear bilevel programming." *SIAM Journal on Scientific and Statistical Computing*, 13, 1194-1217.



- Harvey, S. and Hogan, W.W. (2000). *Nodal and zonal congestion management and the exercise of market power*, Center for Business and Government. John F. Kennedy School of Government, Harvard University, Cambridge, MA.
- Hess, P.M., Moudon, A.V., Snyder, M.C., and Stanilov, K. (1999). "Site design and pedestrian travel." *Transportation Research Record: Journal of the Transportation Research Board*, 1674, 9-19.
- Hoogendoorn, S.P. and Bovy, P.H.L. (2004). "Pedestrian route-choice and activity scheduling theory and models." *Transportation Research Part B: Methodological*, 38(2), 169-190.
- Hunt, J.D. (1988). "Parking Location Choice: Insights and Representations based on Observed Behaviour and Hierarchical Logit Modelling Formulation." *Paper presented to the 5th Annual Meeting of the Institute of Transportation Engineers*, Vancouver.
- Ker, I. and Ginn, S. (2003). *Myths and Realities in Walkable Catchments: The Case of Walking and Transit*. <[findarticles.com/p/articles/mi\\_qa3927/is\\_200306/ai\\_n9255068](http://findarticles.com/p/articles/mi_qa3927/is_200306/ai_n9255068)> (July 26, 2011)
- Kempton, W. (2007). "Vehicle to Grid Power." *Workshop at IEEE Conference*, Washington DC, September.
- Kempton, W. and Dhanju, A. (2006). "Electric vehicles with V2G: storage for largescale wind power." *Windtech Int*, 2(2), 18-21.
- Kempton, W., and Tomic, J. (2005a). "Vehicle-to-grid power implementation: From stabilizing the grid to supporting large-scale renewable energy." *Journal of Power source*. 144(1), 280-294.
- Kempton, W. and Tomic, J. (2005b). "Vehicle-to-grid power fundamentals: Calculating capacity and net revenue." *Journal of Power source*, 144(1), 268-279.
- Kolstad, C.D. (1985). *A Review of the Literature on Bi-Level Mathematical Programming*. Report LA-10284-MS, Los Alamos National Laboratory, Los Alamos, NM.
- Labbe', M. and Marcotte, P., and Savard, G. (1998). "A bilevel model of taxation and its application to optimal highway pricing." *Management Science*, 1608-1622.

- Lam, W.H.K., Li, Z., Huang, H., and Wong, S.C. (2006). "Modeling time-dependent travel choice problems in road networks with multiple user classes and multiple parking facilities." *Transportation Research part B*, 40, 368-395.
- Lambe, T.A. (1996). "Driver Choice of Parking in the City." *Socio. Econ. Plann. Sci.*, 30(3), 207-219.
- Landis, B.W., Vattikuti, V.R., Ottenberg, R.M., McLeod, D.S., and Guttenplan, M. (2001). "Modeling the roadside walking environment: pedestrian level of service." *Transportation Research Record: Journal of the Transportation Research Board*, 1663, 82-88.
- LeBlanc, L.J. (1975). "An Algorithm for the Discrete Network Design Problem." *Transportation Science*, 9, 183-199.
- Lilienthal, P. and Brown, H. (2007). *Potential carbon emissions reductions from plug-in hybrid electric vehicles by 2030*, National Renewable Energy Laboratory (NREL), Golden, CO.
- Litman, T.A. (2003). "Economic value of walkability." *Transportation Research Record: Journal of the Transportation Research Board*, 1828, 3-11.
- Louie, H. and Strunz, K. (2008). "Locational Marginal Pricing in North American Power Systems." *ETG-Fachbericht-Netzregelung und Systemführung*, München, Germany.
- Mak, W., Morton, D.P., and Wood, R.K. (1999), "Monte Carlo bounding techniques for determining solution quality in stochastic programs." *Operations Research Letters*, 24, 47-56.
- Marcotte, P. (1983). "Network optimization with continuous control parameters," *Transportation Science*, 17(2), 181-197.
- Matley, T.M., Goldman, L.M., and Fineman, B.J. (2000). "Pedestrian Travel Potential in Northern New Jersey: A Metropolitan Planning Organization's Approach to Identifying Investment Priorities." *Transportation Research Record: Journal of the Transportation Research Board*, 1705, 1-8.
- Mitchell, M. (1998). *An introduction to genetic algorithms*, MIT Press.

- Morton, D.P. and Popova, E. (2004). "A Bayesian stochastic programming approach to an employee scheduling problem." *IIE Transactions*, 36, 155-167.
- Mulvey, J.M. and Vladimirou H. (1991). "Applying the progressive hedging algorithm to stochastic generalized networks." *Annals of Operations Research*, 31, 399-424.
- Ott, A.L. (2003). "Experience with PJM Market Operation, System Design, and Implementation." *IEEE Transactions on Power Systems*, 18(2), 528-534.
- Parks, K., Denholm, P., and Markel, T. (2007). *Costs and Emissions Associated with Plug-in Hybrid Electric Vehicle Charging in the Xcel Energy Colorado Service Territory*. National Renewable Energy Laboratory (NREL).
- Pereira, M.V.F and Pinto, L.M.V.G. (1991). "Multi-stage stochastic optimization applied to energy planning." *Mathematical Programming*, 52, 359-375.
- Pierce Jr, H.E., Colborn, H.W., Coleman, D.W., Marriage, E.A., Richard, J.C., Rindt, L.J., Rubino, L.J., Stagg, G.W., Traub, T.P., Vandergrift, J., and others (1973). "Common format for exchange of solved load flow data." *IEEE Transactions on Power Apparatus and Systems*, 92(6), 1916-1925.
- Pisarski, A.E. (2006). *Commuting in America III: The Third National Report on Commuting Patterns and Trends*. Transportation Research Board.
- Plastria, F. (1987). "Solving general continuous single facility location problems by cutting planes." *European journal of operational research*, 29(1), 98-110.
- Powell, W.B. (1990). "Real-time optimization for truckload motor carriers." *OR/MS Today*, 17(2), 28-33.
- Short, W. and Denholm, P. (2006). *A preliminary assessment of plug-in hybrid electric vehicles on wind energy markets*. National Renewable Energy Laboratory.
- Solomon, J. and Vincent, R. (2003). *Development and Evaluation of a Plug-in HEV with Vehicle-to-Grid Power Flow*. California Air Resources Board.
- Southworth, M. (2005). "Designing the Walkable City." *Journal of Urban Planning and Development*, 131(4), 246-257.

- Stovall, T.K., Hadley, S.W. and Rizy, D.T. (2005). "Distributed Generation: Who Benefits?" *Public Utilities Fortnightly*, 34-38, March.
- Sullivan, J.L., Salmeen, I.T., and Simon, C.P. (2009). *PHEV marketplace penetration: An agent based simulation*. University of Michigan, Ann Arbor, Transportation Research Institute.
- Takriti, S., Birge, J.R., and Long, E. (1995). "A stochastic model for the unit commitment problem." *IEEE Transactions on Power Systems*, 11(3), 1497-1508.
- Tam, M.L. and Lam, W.H.K. (2000). "Maximum car ownership under constraints of road capacity and parking space." *Transportation research Part A*, 34, 145-170.
- Tatsumi, H. (2003). "Modeling of Parking Lot Choice Behavior for Traffic Simulation." *Journal of the Eastern Asia Society for Transportation Studies*, 5.
- Tong, C.O., Lau, W.W.T, and Wong, S.C. (2004). "A Demand-supply Equilibrium Model for Parking Services in Hong Kong." *Transactions-Hong Kong Institution of Engineers*, 11(1), 48-53.
- U.S. Energy Information Administration (2009). *Annual Energy Outlook 2009: With Projection to 2030*. [http://www.eia.gov/oiaf/aeo/pdf/0383\(2009\).pdf](http://www.eia.gov/oiaf/aeo/pdf/0383(2009).pdf)
- Wardrop, J.G. (1952). "Some theoretical aspects of road traffic research." *Proceedings of the Institution of Civil Engineers Part II*, 1, 325-378.
- Weber, A. (1909). *Über den standort der industrien*. JCB Mohr, 1909.
- Yang, H. and Bell, M.G.H. (1997), "Traffic restraint, road pricing and network equilibrium." *Transportation research Part B*, 31(4), 303-314.
- Zhichun, L., Jaijun, H., Lam, W.H.K., and Wong, S.C. (2007). "Optimization of time-varying parking charges and parking supply in networks with multiple user classes and multiple parking facilities." *Tsinghua science and technology*, 12(2), 167-177.
- Ziliaskopoulos, A.K. (2000). "A Linear Programming Model for the Single Destination System Optimum Dynamic Traffic Assignment Problem." *Transportation Science*, 34(1), 37-49.
- Zimmerman, R.D., Murillo-Sanchez, C.E., and Thomas, R.J. (2011). "Matpower: Steady

State Operations, Planning and Analysis Tools for Power Systems Research and Education."  
IEEE Transactions on Power Systems, 26(1), 12-19.



## APPENDIX

### *Appendix A*

#### Notation of Dynamic Traffic Assignment

- $k$  = density
- $v$  = link free flow speed
- $w$  = backward propagation speed
- $C$  = the set of cells: ordinary ( $C_O$ ), diverging ( $C_D$ ), merging ( $C_M$ ), source ( $C_R$ ), and sink ( $C_S$ )
- $T$  = the set of discrete time intervals
- $x'_i$  = the number of vehicles in cell  $i$  at time interval  $t$
- $N'_i$  = the maximum number of vehicles in cell  $i$  at time interval  $t$
- $y'_{ij}$  = the number of vehicles moving from cell  $i$  to cell  $j$  at time interval  $t$
- $E$  = the set of cell connectors: ordinary ( $E_O$ ), diverging ( $E_D$ ), merging ( $E_M$ ), source ( $E_R$ ), and sink ( $E_S$ )
- $Q'_i$  = the maximum number of vehicles that can flow into or out of cell  $i$  during time interval  $t$
- $\delta'_i$  = ratio  $v/w$  for each cell and time interval
- $\Gamma(i)$  = the set of successor cells to  $i$
- $\Gamma^{-1}(i)$  = the set of predecessor cells to  $i$
- $d'_i$  = demand (inflow) at cell  $i$  in time interval  $t$

**Appendix B**

**Matrix of Demand for Trips**

Origin Nodes	Destination Nodes																							
	1	2	3	4	5	6	7	8	9	10	11	12	13	14	15	16	17	18	19	20	21	22	23	24
1	0	1	1	5	2	3	5	8	5	13	5	2	5	3	5	5	4	:	3	3	1	4	3	1
2	1	0	1	2	1	4	2	4	2	6	2	1	3	1	1	4	2	0	1	1	0	1	0	0
3	1	1	0	2	1	3	1	2	1	3	3	2	1	1	1	2	1	0	0	0	0	1	1	0
4	2	2	2	0	3	4	4	7	7	12	14	6	6	3	3	8	3	:	2	3	2	4	3	1
5	2	1	1	5	0	2	2	5	8	10	5	2	2	1	2	5	2	0	1	1	1	2	1	0
6	3	4	3	4	2	0	4	8	4	8	4	2	2	1	2	9	5	:	2	3	1	2	1	1
7	5	2	1	4	2	4	0	10	6	19	5	7	4	2	5	14	10	2	4	5	2	5	2	1
8	8	5	2	7	5	8	10	0	8	16	8	6	6	4	6	22	14	1	7	9	4	5	3	2
9	2	2	1	7	8	4	6	8	0	25	14	6	6	6	9	14	5	2	4	6	3	7	3	1
10	13	6	3	12	10	8	19	16	28	6	40	20	19	21	40	44	39	7	18	25	12	26	18	8
11	5	2	3	13	5	4	5	8	14	39	0	14	10	16	14	14	10	:	4	6	4	11	13	6
12	2	1	2	6	2	2	7	6	6	20	14	0	13	7	7	7	6	2	3	4	3	7	7	5
13	5	3	1	6	2	2	4	6	6	19	10	13	0	6	7	6	5	:	3	6	6	13	11	2
14	3	1	1	5	1	1	2	4	6	21	16	7	6	0	13	7	7	:	3	5	4	12	11	4
15	5	1	1	5	2	2	5	6	10	40	14	7	7	13	0	12	15	2	8	11	8	26	10	4
16	5	4	2	8	5	9	14	22	14	44	14	7	6	7	12	0	23	5	13	16	6	12	5	3
17	4	2	1	5	2	5	10	14	9	39	10	6	5	7	15	28	6	6	17	17	6	17	6	3
18	1	0	0	1	0	1	2	3	2	7	2	2	1	1	2	5	6	0	3	4	1	3	1	0
19	3	1	0	2	1	2	4	7	4	15	4	3	3	3	8	12	17	3	0	12	4	11	3	1
20	3	1	0	3	1	3	5	9	6	25	6	5	6	5	11	16	17	4	12	0	12	24	7	4
21	1	0	0	2	1	1	2	4	3	12	4	3	6	4	8	6	6	:	4	12	0	18	7	5
22	4	1	1	4	2	2	5	5	7	26	11	7	13	12	26	12	17	3	12	24	18	0	21	11
23	3	0	1	5	1	1	2	3	5	13	13	7	8	11	10	5	6	:	3	7	7	21	0	7
24	1	0	0	2	0	1	1	2	2	8	6	5	7	4	4	3	3	0	1	4	5	11	7	0



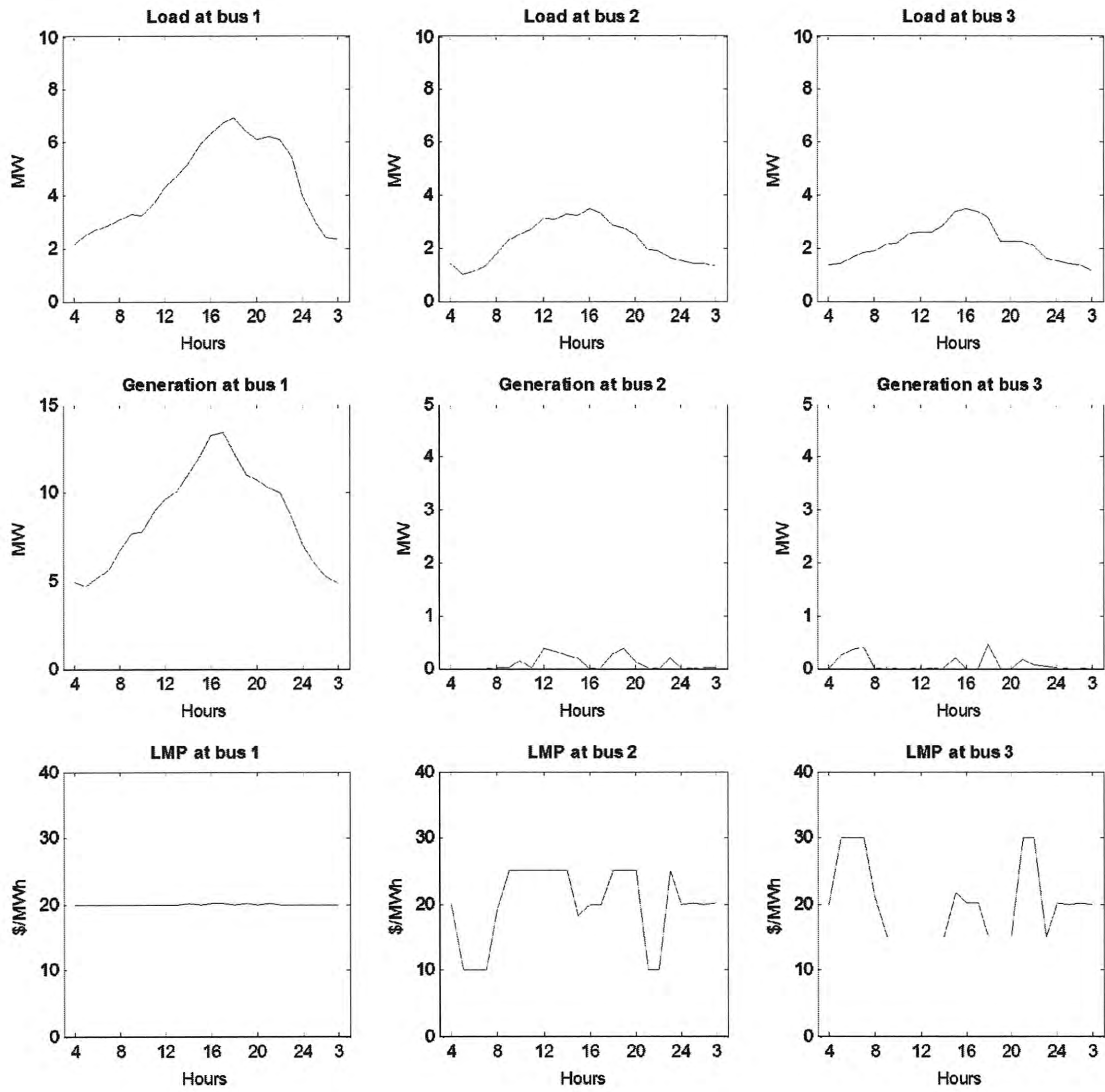
**APPENDIX C**

**Cost Function Parameters**

Links	Parameters		Links	Parameters	
	A	B		A	B
(7,18) and (18,7)	0.02	0.00000001	(13,24) and (24,13)	0.04	0.00000893
(10,15) and (15,10)	0.06	0.00000027	(24,21) and (21,24)	0.03	0.00000790
(3,4) and (4,3)	0.04	0.00000007	(20,21) and (21,20)	0.06	0.00001673
(1,3) and (3,1)	0.04	0.00000002	(2,6) and (6,2)	0.05	0.00001241
(1,2) and (2,1)	0.06	0.00000002	(6,8) and (8,6)	0.02	0.00000521
(3,12) and (12,3)	0.04	0.00000002	(7,8) and (8,7)	0.03	0.00000119
(12,13) and (13,12)	0.03	0.00000001	(5,6) and (6,5)	0.04	0.00001001
(18,20) and (20,18)	0.04	0.00000003	(23,24) and (24,23)	0.02	0.00000451
(10,11) and (11,10)	0.05	0.00000075	(21,22) and (22,21)	0.02	0.00000401
(16,18) and (18,16)	0.03	0.00000003	(14,23) and (23,14)	0.04	0.00001020
(15,19) and (19,15)	0.03	0.00000010	(22,23) and (23,22)	0.04	0.00000960
(10,17) and (17,10)	0.03	0.00001930	(14,15) and (15,14)	0.05	0.00001085
(8,9) and (9,8)	0.08	0.00002306	(16,17) and (17,16)	0.02	0.00000401
(4,11) and (11,4)	0.10	0.00001550	(17,19) and (19,17)	0.02	0.00000554
(5,9) and (9,5)	0.06	0.00000075	(19,20) and (20,19)	0.04	0.00000958
(9,10) and (10,9)	0.05	0.00000012	(11,14) and (14,11)	0.04	0.00001061
(15,22) and (22,15)	0.03	0.00000053	(20,22) and (22,20)	0.05	0.00001130
(11,12) and (12,11)	0.06	0.00001550	(8,16) and (16,8)	0.05	0.00001157
(4,5) and (5,4)	0.02	0.00000003	(10,16) and (16,10)	0.04	0.00001080

## APPENDIX D

### Power Load, Generation, LMP without PEV Parking Building



## **APPENDIX E**

### **Notation of Data Format**

#### **Generator Data Format**

bus	=	bus number
Pg	=	real power output (MW)
Qg	=	reactive power output (MVA <sub>r</sub> )
Qmax	=	maximum reactive power output (MVA <sub>r</sub> )
Qmin	=	minimum reactive power output (MVA <sub>r</sub> )
Vg	=	voltage magnitude setpoint (p.u.)
mBase	=	total MVA base of this machine, defaults to baseMVA
status	=	> 0 – machine in service ≤ 0 – machine out of service
Pmax	=	maximum real power output (MW)
Pmin	=	minimum real power output (MW)

#### **Branch Data Format**

fbus	=	from bus number
tbus	=	to bus number
r	=	resistance (p.u.)
x	=	reactance (p.u.)
b	=	total line charging susceptance (p.u.)
rateA	=	MVA rating A (long term rating)
rateB	=	MVA rating B (short term rating)
rateC	=	MVA rating C (emergency rating)
ratio	=	transformer off nominal turns ratio (= 0 for lines)
angle	=	transformer phase shift angle (degrees)
status	=	1 – in service 0 – out of service





